

Research Article

Reduction of $1/f$ Noise in Single-Walled Carbon Nanotubes (SWCNTs) Using Gas Adsorption Technique

L. Natrayan ¹, S. Angalaeswari ², S. Kaliappan,³ C. Naga Dheeraj Kumar Reddy ⁴,
V. Sivaprakash ⁵, Pravin P. Patil,⁶ and P. Murugan ⁷

¹Department of Mechanical Engineering, Saveetha School of Engineering, SIMATS, Chennai, 602105 Tamil Nadu, India

²School of Electrical Engineering, Vellore Institute of Technology, Chennai, Tamil Nadu 600 127, India

³Department of Mechanical Engineering, Velammal Institute of Technology, Chennai, Tamil Nadu, India

⁴Department of Civil Engineering, Aditya College of Engineering and Technology, Surampalem, Affiliated to Jawaharlal Nehru Technological University Kakinada, East Godavari District, Kakinada, India

⁵Department of Mechanical Engineering, Sathyabama Institute of Science and Technology, Chennai, Tamil Nadu, India

⁶Department of Mechanical Engineering, Graphic Era Deemed to Be University, Bell Road, Clement Town, 248002 Dehradun, Uttarakhand, India

⁷Department of Mechanical Engineering, Jimma Institute of Technology, Jimma University, Ethiopia

Correspondence should be addressed to L. Natrayan; natrayanl.sse@saveetha.com, S. Angalaeswari; spkavisp@gmail.com, C. Naga Dheeraj Kumar Reddy; chukkanaga@gmail.com, and P. Murugan; murugan.ponnusamy@ju.edu.et

Received 22 January 2022; Revised 20 March 2022; Accepted 26 March 2022; Published 12 April 2022

Academic Editor: Lakshmi pathy R

Copyright © 2022 L. Natrayan et al. This is an open access article distributed under the Creative Commons Attribution License, which permits unrestricted use, distribution, and reproduction in any medium, provided the original work is properly cited.

Single-walled carbon nanotube (SWCNT) plays a major role in electromagnetic absorption and shielding. Their applications as semiconductors make a breakthrough in communication by miniaturizing the communication devices. The main drawback of the SWCNT is found to $1/f$ noise. Because of this limitation, high attenuation at the low-frequency band cannot be achieved, limiting its application in terms of selectivity. The spectral density study shows that the noise's amplitude is directly proportional to the temperature and inversely proportional to the number of carriers in the nanotube. The SWCNT is mainly synthesized using hydrocarbons which contains carbonaceous impurities. On the removal of impurities, more surface oxygen functional groups are formed. On the other hand, the diameter of the carbon nanotube is very small, increasing the resistance of carrier flow. In this research work, gas adsorption was used in SWCNT by treating the carbon nanotube using nitric acid. Isotherms determine porous size. The adsorbate-adsorbent interaction on carbon nanotube reduces the microporosity in the surface by treating with nitric acid. Therefore, the density of the surface increases and the CNT bundle separation will be reduced, increasing the carbon nanotube's resistivity. This increase in resistivity reduces the excess carrier flow; therefore, the temperature will reduce the $1/f$ noise. The proposed system is cost-effective and has shown 11% improvement by reducing the noise amplitude by increasing carbon nanotube resistance. This proposed method has less complexity compared with existing models.

1. Introduction

The CNTs are nanosized graphene cylinders that help to build metal-free wires. The CNTs help make tiny, flimsy, and tensile electronic devices, which is the current trend in building communication devices [1]. Their applications include structural, thermal conductivity, field emission, and absorption; the CNTs are categorized depending on the

number of layers by single-walled CNT (SWCNT), double-walled CNT (DWCNT), and multiwalled CNT (MWCNT). Depending on the orientation of the lattice, they are divided into three ways: armchair, zigzag, and chiral model [2]. The metallic or semiconductor property of SWCNTs [3] depends on the difference between n and m units of the nanostructure of the graphene. Their main application is conductive wires in electronic devices. The other application of SWCNT

includes smart textiles, CMOS batteries, RFID chips, transistor, and integrated circuits [4]. The CNTs are used as antennas in communication systems. CNTs have the major advantage of the anticorrosive property, whereas metal conductors are prone to more corrosion. The main requirements of antennas are fulfilled by CNTs like good conductivity, specific surface area, and lightweight. CNTs are molecular wire-based antennas and they find applications as dipole antennas, infinitely long antennas, optical antennas, bundle dipole antennas, thread bowtie antennas, and patch antennas [5]. Even though CNTs find many applications as antennas, their conductivity is not equivalent to copper antennas. Many methods are employed to increase the conductivity of antennas like doping, bundling, and fusion of both. The presence of noise also reduces the conductivity of the antenna during operation. Pink or $1/f$ noise is a kind of noise that occurs at a low-frequency band [6]. This noise is encountered in the CNT antennas, which reduces the system's conductivity. The main source of pink noise in electronic devices is fluctuating defects in composite materials used. Another reason for pink noise is due to temperature dependency [7]. Hydrogen adsorbed on platinum or nickel is an example of chemisorption. Chemisorption is highly specific, localized, and immobile, where there is no migration of adsorbed molecules from one site to another. Usually, a monolayer is formed on the adsorbent surface in chemisorption, while multilayers are formed in the case of physisorption. The pink noise is inversely proportional to the frequency and number of carriers in the nanotube. As the number of carriers increases, the temperature will increase due to less resistivity, increasing the noise amplitude in the CNT films. So resistivity of the material can be increased by making the surface of CNT denser so that pink noise will get reduced. Langmuir and Freundlich's adsorption isotherms have limitations in explaining adsorption results from solutions. The former lacks a theoretical basis, and the latter assumes the adsorbent surface to be homogeneous concerning adsorption energy. Thus, the gas adsorption technique is used to find the SSA, porous distribution, and pore size present between bundles, and it can be treated with nitric acid. This paper proposes using the gas adsorption technique to reduce the $1/f$ noise in the lower frequency band [8]. Polanyi's potential theory, although widely applicable in adsorption techniques for treating wastewater, it has limitations. One limitation results from the assumption that all the pores are accessible to the adsorbate. In practice, it is not true. There are some pores fine enough to exhibit exclusion of some adsorbates, which are larger. The second theory is limited to adsorption caused by London forces only. It does not consider the chemisorptive effects of specific groups, such as surface-oxygen chemical structures that are invariably present on carbon surfaces.

Few works of literature are available in the methods for reducing the $1/f$ noise. This research work's novelty is proposing a new methodology of surface treatment of carbon nanotubes instead of doping and bundling methods. In this paper, the nitric acid will be treated on the surface of carbon nanotube composites so that the defects and imperfections on the surface are reduced, which helps reduce the $1/f$ noise.

2. Materials and Method

The CNTs are formed by rolling the single layer of graphene (SWCNT) or multilayer graphene, forming cylindrical shapes containing hydrocarbons in a hexagonal arrangement. The CNTs are the strongest material known with less weight and high flexibility [9]. Their applications are for making bulletproof jackets, sporting goods, manufacturing aircraft parts, thin-film transistors, and manufacturing biosensors and electrochemical sensors used to study electrochemical reactions [10].

The SWCNT is composed of 10 atoms, and its thickness is about a single atom. Chemical Vapor Deposition (CVD) method is used for synthesizing the SWCNT of 30-50%, whereas the arc discharge synthesis method produces nearly 80% of the highest purity. During synthesis, catalyst is required. It requires simple control overgrowth and atmospheric conditions; bulk production is difficult to synthesize. During synthesis, there occur more defects, and it has a resistivity range of 10^{-4} to $10^{-3} \Omega\cdot\text{m}$. It has poor purity; twisting is easy and has good elasticity [11]. The evaluation of SWCNT is done with the help of a specific surface area, and its characterization can be done easily. The bandgap SWCNT is 0-2 electron volts. It acts as both metallic and semiconductor. The length of SWCNT is about 2 nm. Many SWCNTs are stacked, one inside the other, resulting in MWCNT, where it is limited to an outer diameter less than 15 nm and has an inner diameter range of around 2-20 nm. It has a very complex structure, and twisting MWCNT is difficult. Its resistivity is low compared to SWCNT, which has a range of 1.8×10^{-5} to $6.1 \times 10^{-5} \Omega\cdot\text{m}$. Catalyst is not required for production and is homogeneously dispersed without apparent bundle formation [12]. By the CVD method, 35%-90%wt is possible. It has high purity and less defect when synthesized using the arc discharge method. Their length is about 5-6 micrometers. The MWCNT is different from carbon fibres because carbon fibres do not have a hollow structure. The CNTs are the strongest material known with less weight and high flexibility [13]. Figure 1 shows the two-dimensional representation of lattices of SWCNT.

The CS of the radius of a single carbon nanotube is given by

$$a = \frac{\sqrt{3}}{2\pi} b \sqrt{m^2 + n^2 + mn}. \quad (1)$$

The creation of nanotubes depends upon how the graphite is rolled upon. It is divided into armchair carbon nanotubes, zigzag carbon nanotubes, and chiral nanotubes. Figure 2 shows the structure of SWCNT and MWCNT. Depending on the (n, m) indices of SWCNT, different structures formed and properties vary. The zigzag nanotubes act as metallic or semiconductor materials, and their indices can be represented by $(n, 0)$ and $(0, m)$. Here, the chiral angle is about 0° . If the zigzag method is rotated with chirality of 30° with indices $m = n$, it forms the armchair carbon nanotubes. It acts as metallic always. If both the indices are unequal, i.e., $m \neq n$, then it is chiral carbon nanotubes. It acts

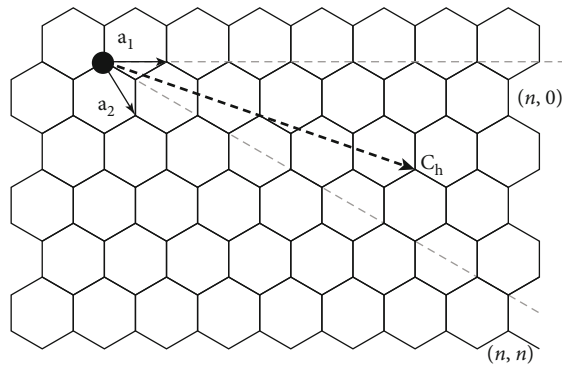

FIGURE 1: Two-dimensional representation of lattices of SWCNT.

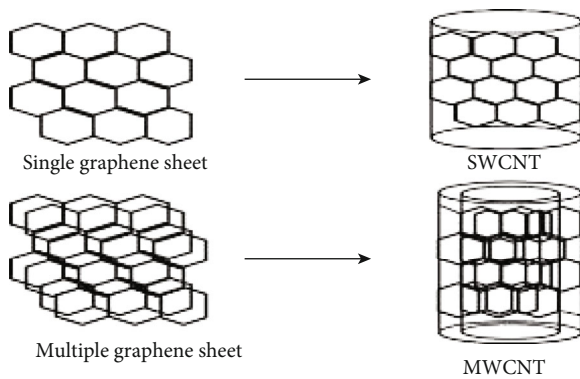

FIGURE 2: Structure of SWCNT and MWCNT.

as a metallic or semiconductor according to the index values. Both the zigzag and chiral carbon nanotubes have metal and semiconductor properties. If the formula $(2n + m)/3$ is an integer, then CNT acts like metal [14]. Apart from its structure, the CNT can act as a semiconductor depending upon the diameter of the tube and band gap value. Different structures of SWCNT are shown in Figure 3.

2.1. Specific Surface Area of the Single Carbon Nanotube. Certain hypotheses are considered for CNTs for the SSA calculations: (a) the tubes are closed, and the external surfaces are alone taken into considerations; (b) the length of the c-c bond is $d_{c-c} = 0.1421$ nm; (c) the aspect ratio should be greater than 1000; (d) the intershell distance should be $d_{s-s} = 0.34$ nm. The surface of one hexagonal CNT is given by

$$s_h = 3d_{c-c}^2 = 5.246 \times 10^{-20} \text{ m}^2. \quad (2)$$

On taking into account of the atomic weight of two carbons,

$$w_h = \left(\frac{2M_c}{N} \right), \quad (3)$$

where $M_c = 12.01$ g/mol and Avogadro number $N =$

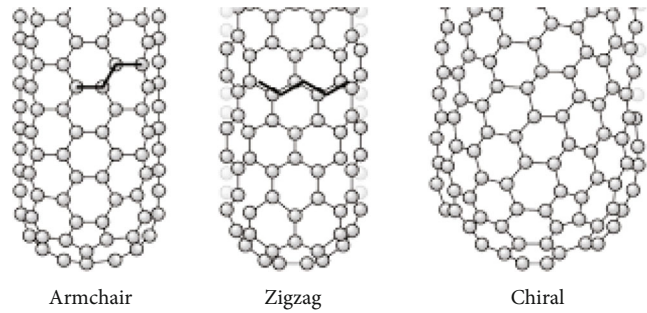

FIGURE 3: Different structures of SWCNT.

$6.023 \times 10^{23} \text{ mol}^{-1}$. Therefore,

$$\text{SSA} = \frac{s_h}{w_h}, \quad (4)$$

$$\text{SSA (SWCNT)} = 1315 \text{ m}^2/\text{g}.$$

2.2. Carbon Nanotube Antennas. The evolution of carbon nanotubes as antennae happens when their length is compatible with the microwave frequency wavelength. The interconnection between the nanoelectronic devices with the metal wire is very difficult, which paved the way for carbon nanotube application as antennae [15]. It is a wireless nanolithographic connection with the macroscopic world. Many electronic devices such as transistors, amplifiers, mixers, and resonators are carbon nanotubes used. Hence, intervention of the antenna is also necessary to make the complete system work under the same platform which eases the operation of the whole system and reduces the loss [16]. The other properties of carbon nanotubes that dominated the conventional antennae are anticorrosive, less weight, high input impedance, tunable conductivity, enhanced flexibility and durability, low cost, slow-wave used at resonant conditions, less thermal expansion coefficient, nonoxidizing nature, high tensile strength, immunity to environmental factors, high surface area, and ease of fabrication [17]. The types of carbon nanotube antennae manufactured so far are CNT dipole antennae, CNT thread antennae, CNT thin film antennae, CNT infinitely long antennae, optical antenna, armchair CNT antennae, bundle dipole antenna, and CNT patch antennae [18]. The carbon nanotube antennae find application in biosensors, human body communications, spying and military applications, textile industries, high-rate RF nanoreceivers, active and passive microwave nanodevices, quasioptical polarizers, wearable radio frequency antennae and sensors, etc.

2.3. Application of Carbon Nanotube as Different Types of Antennae

2.3.1. Carbon Nanotube as Dipole Antenna. Burke et al. [19] studied nanotube and nanowire characteristics and used them as antennae. The dipole antenna was also calculated using carbon nanotube quantitative analysis [19].

The carbon nanotube length matches the wavelength of the microwave frequency, and it also operates at the terahertz range. Figure 4 shows the carbon nanotube as a dipole

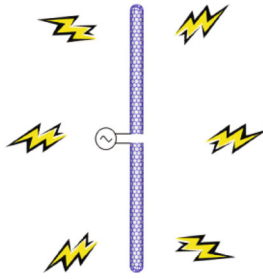

FIGURE 4: Carbon nanotube as dipole antenna.

antenna. The dipole antennas obtained from carbon nanotube have less electrical conductivity than copper materials. From Table 1, it is clear that except for the conductivity, all other parameters are high for carbon nanotube compared to copper. The input impedance of the carbon nanotube dipole antenna is very high. The skin effect has less impact on the carbon nanotube antennas. Reducing the carbon nanotube antenna to half the wavelength can be used as resonant dipole antennas. The CNT transmission line section can be analyzed by quantum capacitance and kinetic inductance carried out by Burke et al. [19]. Hanson et al. calculated the macroscopic surface conductivity of CNT based on the integral equation [20]. Its attenuation coefficient at the low-frequency band is less, reducing the active part of dipole length. This kind of antenna acts below the resonance value with capacitive impedance. The conductivity of the carbon nanotube antenna is mainly based upon chirality. Usually, the armchair structure of carbon nanotubes is used as dipole antennas. Because of the small diameters, it has less resistance, leading to less conductivity than copper [21].

2.3.2. Carbon Nanotube as Thread Antennas. The lightweight requirement of antennas for various applications limits the use of copper because of its low tensile strength. Figure 5 shows the CNT thread antenna. The satellite, aerospace, and wearable sensor application requires less weight and radiation efficient antennas [22]. The carbon nanotube dipole antennas have less weight, but their conduction efficiency is very low. Thus, the evolution of carbon nanotube thread antennas resolved the problem over dipole antennas. CNT thread antennas are as efficient as copper. This antenna functions efficiently at the medical frequency and WLAN bands [23].

2.3.3. Carbon Nanotube as Patch Antennas. The carbon nanotube has favourable properties to act as patch antennas. The patch antennas have microstrip with one side of dielectrics and the other side ground to the plane. It is easily manufactured using PCB. Using Kapton tape surface, carbon nanotubes will have an adhesion bonding mechanism on one side and laminating protective layer on the other side [24]. Then, one side of it will be attached with dielectrics, and the other side will be fed to line or grounded. The antenna's efficiency can be increased by arraying or bundling of CNTs. The orientation polarization of CNT is the same as that of copper microstrip patch antennas [25]. Figure 6 shows the normal carbon nanotube patch antennas and the

arraying model. The conductance at the end of the antenna reduces the antenna's efficiency compared with copper antennas. Its main application involves WLAN application, geostationary satellites, radar, etc.

2.3.4. Carbon Nanotube as Optical Antenna. The carbon nanotubes exhibit the property of photoluminescence which help to behave like an optical antenna [26]. The exciton and triplet states of carbon nanotubes are studied using Raman spectroscopy, which reveals good optical properties. The wavelength of light matches the characteristic length of the antenna, which has more than 10 nm. Its main application involves solar cells [27].

The conductivity of the antenna is very low compared to the conventional copper antenna, so to increase the conductivity, doping and bundling processes are involved [28]. So depending on the enhancement of conductivity, it is divided into six types. They are

- (i) doped SWCNT based
- (ii) bundled SWCNT based
- (iii) hybrid SWCNT based
- (iv) doped MWCNT based
- (v) bundled MWCNT based
- (vi) hybrid MWCNT based

(1) *Doped SWCNT Based.* Usually, doping happens in two ways: doping with chemicals and doping with conducting materials. Using the doping method radiation efficiency of conductivity increased compared to copper antennas. Their main application is at textiles where conformal antenna over polymer ceramic materials obtained has a gain of 6 dBi and frequency of 2 GHz obtained [29].

(2) *Bundled SWCNT Based.* The bundled SWCNT antenna works 80% more efficient than conventional antennas. Here, more bundles of carbon nanotubes are used to increase the radiation efficiency. The diameter of the cylinder increases it making the electron very easy and reducing the antenna's resistance. They find main applications as thread antennas and as MIMO antennas.

(3) *Hybrid SWCNT Based.* Here, the above two techniques are mingled, which yields the good conductivity equivalent to conventional antennas. It not only increases the radiation efficiency but also operates in multiband. It finds applications in conformal RFID antennas for gas detection, a meander line-shaped dual-band antenna, bowtie meander dipole antenna, and conformal patch antennas [30].

(4) *Doping MWCNT Based.* Doping of MWCNT antenna with polyaniline and KAuCl_4 increases the antenna's efficiency. The wider impedance bandwidth of 19% was achieved with doping compared to copper with only 5% bandwidth. Its applications include flexible UWB antenna,

TABLE 1: Analysis of percentage of carbon nanotube compared with copper for various parameters.

Parameters	Percentage calculation of carbon nanotube compared with copper
Electrical conductivity	CNT produces only 11% efficiency as that of copper
Specific electrical conductivity	CNT is 67% more efficient than copper
Current carrying capacity	CNT is 99% more efficient than copper
Tensile strength	CNT is 89% more efficient than copper
Specific tensile strength	CNT is 98% more efficient than copper
Axial thermal conductivity	CNT is 68% more efficient than copper

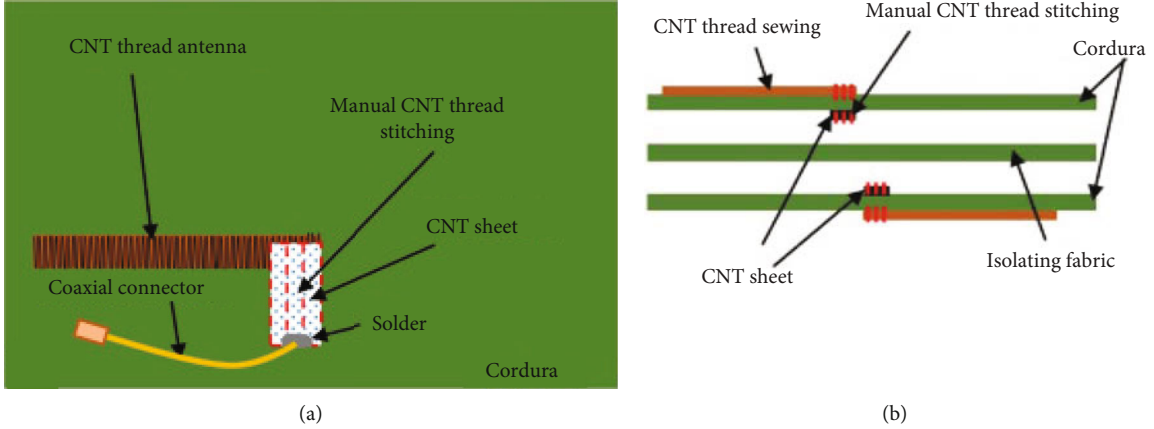

FIGURE 5: CNT thread antenna.

gold-doped MWCNT sheets, frequency tuning applications, and humidity sensors.

(5) *Bundled MWCNT Based.* Here, the number of walls ranging from 2 to 20 is obtained by this bundling technique, which reduces the resistance and increases efficiency. Its application involves an X-a band microstrip patch antenna and is used to manufacture THz antennas.

(6) *Hybrid MWCNT Based.* These techniques are not many studies, but theoretically, it is expected to yield good efficiency. It involves mesh-based patch antennas.

2.4. *Circuit Model.* The two-transmission line model of carbon nanotube tube is analyzed by Burke et al. [19]. Here, the transmission line characteristics are studied using Kirchhoff law applying to the circuit model in Figure 7. The differential equation obtained is as follows:

$$\frac{\partial^2 V_d}{\partial x^2} - \gamma_p^2 = 0, \quad (5)$$

where

$$\gamma_p^2 \equiv 2 \left(R + \frac{j\omega L_k}{4} \right) (j\omega C_T). \quad (6)$$

Here, L_k is the kinetic inductance which is given by

$$L_k = \frac{h}{2e^2 v_f}. \quad (7)$$

Here, h is of Planck's constant, e is electronic charge, and v_f is of the velocity of graphene.

C_T in the equation is called quantum capacitance which is given by

$$C_T = \frac{2e^2}{h v_f}. \quad (8)$$

2.5. *Problems and Solution.* The main drawback of the system is less conductivity of the carbon nanotube antenna than the copper antenna. Many methods like doping, bundling, and hybrid of both techniques are done. The main problem behind less conductivity of the antenna is the small diameter of the carbon nanotube used. Due to its small diameter, the electron flow has been restricted, resulting in high resistance. At the lower frequency band, a particular noise called pink or $1/f$ noise is present in carbon nanotubes, which adds noise to the system and reduces its efficiency. Pink noise is both frequency and temperature dependent. The noise amplitude is inversely proportional to the frequency and no. of carriers in the nanotube. The number of carriers decreases due to resistance, leading to an increase in the noise amplitude. So here, the conductivity

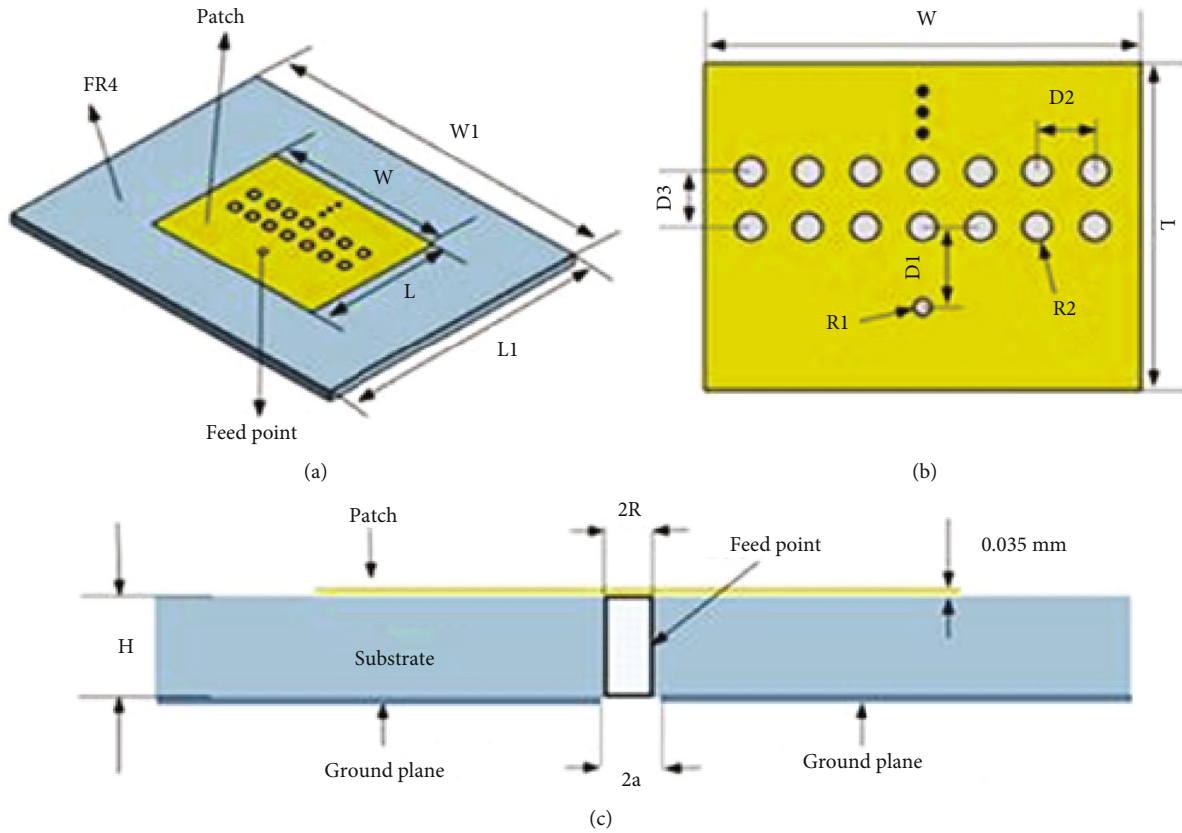

FIGURE 6: CNT patch antennas.

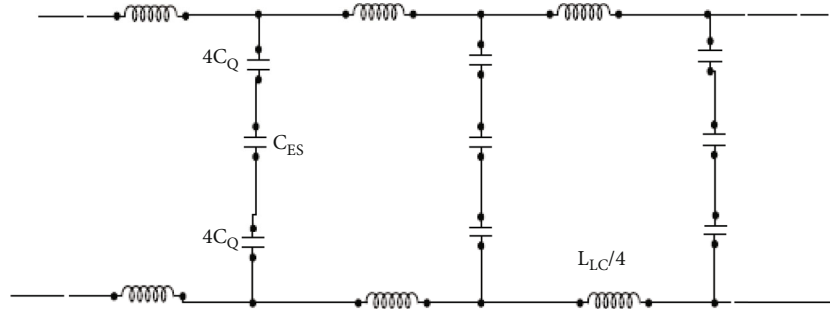

FIGURE 7: Two transmission line models of carbon nanotube antennas.

TABLE 2: Simulation parameters.

Parameters	Value
Indices	$m = n = 40$
The radius of the carbon nanotube	$a = 2.7 \text{ nm}$
Frequency of operation	1 to 10 GHz
Resistance of carbon nanotube	12.6 k Ω
DC currents	0 to 100 nA

reduces with an increase in the temperature. The pink noise usually occurs due to manufacturing defects, flaws in the surface of the composites, and catalyst defects.

2.6. Experimental Procedure. Pink noise is one of the reasons for less conductivity in the carbon nanotube antenna and limits its operation in the low-frequency band. Techniques like doping and bundling are introduced to reduce the noise amplitude. But it increased the complexity and increased the cost of the system. This paper proposes a novel method for reducing the $1/f$ noise using the gas adsorption technique. Adsorption is a surface-oriented phenomenon of adsorbate-adsorbent interactions. Gas adsorption involves gases like nitric acid and CO_2 , acting as adsorbate on the material's surface according to the calculation by isotherms. Isotherms calculate the porous and nonporous characteristics of adsorbents. The noise is due to the flaws or defects on the surface of the carbon nanotube material. This defect leads to the presence of many porous in the material. In

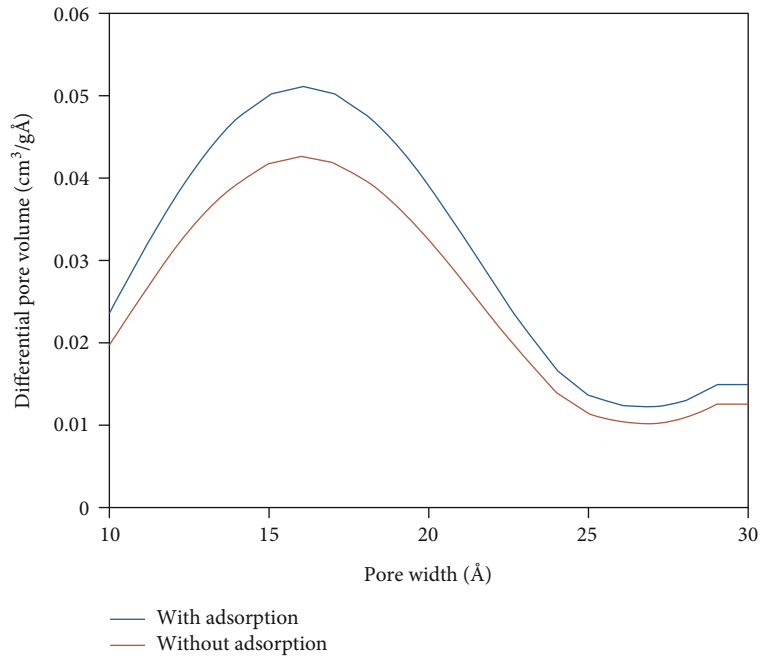

FIGURE 8: Pore size distribution plot of carbon nanotube.

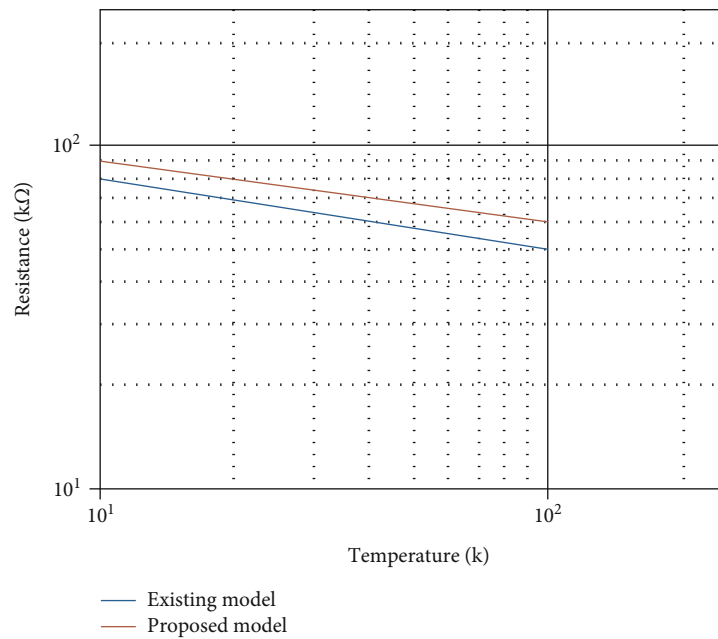

FIGURE 9: Temperature vs. resistance plot.

turn, the presence of many porous leads to a smaller number of carrier transport, which may increase noise amplitude. There is also the possibility of carbonaceous impurities like carbon nanoparticles and amorphous carbon, which can be removed by adding a catalyst to the surface of the carbon nanotube. The porous now is removed by treating the carbon nanotube with nitric acid at 77 K. In treatment, nitric acid reduces the porous size. It occupies a powerful position between the bundles so that defects and flaws are compensated by nitric acid treatment once defects are overcome,

reducing the $1/f$ noise and making the carbon nanotube work even at a low-frequency band.

3. Results and Discussions

The nitric acid is treated on the surface of the carbon nanotube using the gas adsorption technique. The treatment of nitric acid is done at 77 K. The simulation is carried out using MATLAB 2021b. The simulation parameters used are given in Table 2. The isothermal heat of adsorption is

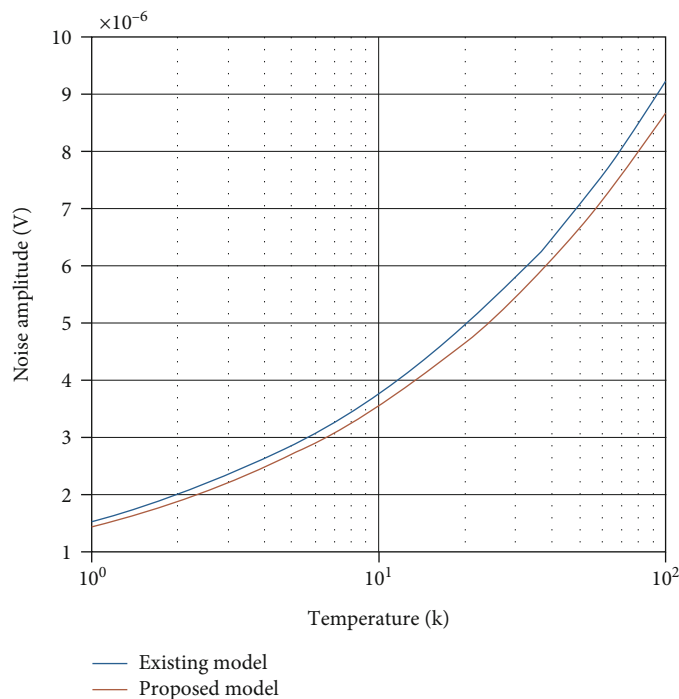

FIGURE 10: Temperature vs. noise amplitude plot for carbon nanotube.

used to calculate the pore size distribution. The pore size distribution is calculated by measuring pore width and differential pore volume. Figure 8 shows the simulated results of pore size distribution with and without adsorption. Before adsorption, it is seen that differential pore volume is less compared to the value after adsorption. After adsorption, the pore width is occupied by treated nitric acid volume so that density of the surface increases, increasing the number of carriers.

Figure 9 shows the temperature versus resistance plot. The simulation was taken before and after the adsorption technique. After treating with nitric acid, the pore size will be reduced, and the surface will become denser. Now, the resistance of the carbon nanotube increases. After incrementing of resistance, their unwanted carriers are restricted so that the temperature stability of the device will increase.

Figure 10 shows the temperature vs. noise amplitude plot. The simulation is done for the existing and proposed model. This is the most important result showing the variation in the noise amplitude. In the figure, the proposed work shows less noise amplitude compared to the existing model. The noise amplitude here is reduced due to the increase in the resistance of the carbon nanotube. From the simulation, it is seen that 11% efficiency is increased after treating nitric acid. Consequently, the carbonized product is subjected to activation treatment in an oxidizing atmosphere, which removes the tarry material and the disorganized carbon. Besides making available the porosity already created during carbonization, the activation process also creates some additional porosity.

The treatment of wastewater containing malathion (organophosphorus pesticides) is done with activated car-

bon. As adsorption is a surface or interfacial phenomenon, surface characteristics particularly the surface area of carbon are important and determine the extent of adsorption from solutions. The surface area of most of the commercially used activated carbons ranges from 800 to 1200 m²/g. Experimental values for the Langmuir parameters indicated that the magnitudes were quite similar with the exception of parathion. The value of K was higher in this case than that of other pesticides indicating its higher energy of adsorption. The percentage removal of chemical oxygen demand, organic phosphorous, and nitrophenol from wastewater was 50, 90, and >90%, respectively.

4. Conclusion

The experiment of treating nitric acid with carbon nanotubes to overcome the $1/f$ noise uses MATLAB software.

The results show an 11% improvement compared to the conventional carbon nanotubes.

The cost of utilizing the adsorption technique is low compared to the already existing techniques.

The work can be further carried out by finding the system's efficiency after 6 and 10 hours of adsorption.

Data Availability

The data used to support the findings of this study are included within the article. Should further data or information be required, these are available from the corresponding author upon request.

Conflicts of Interest

The authors declare that there are no conflicts of interest regarding the publication of this paper.

Acknowledgments

The authors thank Saveetha School of Engineering, SIMATS, Chennai, for providing characterization support to complete this research work.

References

- [1] S. Iijima, "Helical microtubules of graphitic carbon," *Nature*, vol. 354, no. 6348, pp. 56–58, 1991.
- [2] Y. Devarajan, B. Nagappan, G. Subbiah, and E. Kariappan, "Experimental investigation on solar-powered ejector refrigeration system integrated with different concentrators," *Environmental Science and Pollution Research*, vol. 28, no. 13, pp. 16298–16307, 2021.
- [3] H. W. Kroto, J. R. Heath, S. C. O'Brien, R. F. Curl, and R. E. Smalley, "C₆₀: buckminsterfullerene," *Nature*, vol. 318, no. 6042, pp. 162–163, 1985.
- [4] F. Hennrich, C. Chan, V. Moore, M. Rolandi, and M. O'Connell, *Carbon Nanotubes Properties and Applications*, Taylor & Francis Group, 2006.
- [5] N. P. Valentin, "Carbon nanotubes: properties and application," *Materials Science and Engineering R*, vol. 43, no. 3, pp. 61–102, 2004.
- [6] S. Iijima and T. Ichihashi, "Single-shell carbon nanotubes of 1-nm diameter," *Nature*, vol. 363, no. 6430, pp. 603–605, 1993.
- [7] P. Sureshkumar, T. Jagadeesha, L. Natrayan, M. Ravichandran, D. Veeman, and S. M. Muthu, "Electrochemical corrosion and tribological behaviour of AA6063/Si₃N₄/Cu(NO₃)₂ composite processed using single-pass ECAP_A route with 120° die angle," *Journal of Materials Research and Technology*, vol. 16, pp. 715–733, 2022.
- [8] Y. Devarajan, B. T. Nalla, M. D. Babu, G. Subbiah, R. Mishra, and S. Vellaiyan, "Analysis on improving the conversion rate and waste reduction on bioconversion of *Citrullus lanatus* seed oil and its characterization," *Sustainable Chemistry and Pharmacy*, vol. 22, p. 100497, 2021.
- [9] G. W. Hanson, "Fundamental transmitting properties of carbon nanotube antennas," *Institute of Electrical and Electronics Engineers*, vol. 53, no. 11, pp. 3426–3435, 2005.
- [10] G. Y. Slepian, S. A. Maksimenko, A. Lakhtakia, O. M. Yevtushenko, and A. V. Gusakov, "Electrodynamics of carbon nanotubes: dynamic conductivity, impedance boundary conditions, and surface wave propagation," *Physical Review B*, vol. 60, no. 24, pp. 17136–17149, 1999.
- [11] M. Attiya, "Lower frequency limit of carbon nanotube antenna," *Progress In Electromagnetics Research*, vol. 94, pp. 419–433, 2009.
- [12] H. Arun, "Advancements in the use of carbon nanotubes for antenna realization," *International Journal of Electronics and Communications*, vol. 136, p. 153753, 2021.
- [13] P. Asha, L. Natrayan, B. T. Geetha et al., "IoT enabled environmental toxicology for air pollution monitoring using AI techniques," *Environmental Research*, vol. 205, p. 112574, 2022.
- [14] B. H. Bejaxhin, G. Paulraj, and S. Aravind, "Influence of TiN/AlCrN electrode coatings on surface integrity, removal rates and machining time of EDM with optimized outcomes," *Materials Today: Proceedings*, vol. 21, pp. 340–345, 2020.
- [15] G. Choubey, P. M. Yadav, Y. Devarajan, and W. Huang, "Numerical investigation on mixing improvement mechanism of transverse injection based scramjet combustor," *Acta Astronautica*, vol. 188, pp. 426–437, 2021.
- [16] J. Feizy, Z. Es'haghi, and R. Lakshmipathy, "Aflatoxins' clean-up in food samples by graphene oxide–polyvinyl poly pyrrolidone–hollow fiber solid-phase microextraction," *Chromatographia*, vol. 83, no. 3, pp. 385–395, 2020.
- [17] V. S. Ponnappan, B. Nagappan, and Y. Devarajan, "Investigation on the effect of ultrasound irradiation on biodiesel properties and transesterification parameters," *Environmental Science and Pollution Research*, vol. 28, no. 45, pp. 64769–64777, 2021.
- [18] S. G. El-Sherbiny, S. Wageh, S. M. Elhalafawy, and A. A. Sharshar, "Carbon nanotube antennas analysis and applications: review," *Advances in Nano Research*, vol. 1, no. 1, pp. 13–27, 2013.
- [19] P. J. Burke, Shengdong Li, and Zhen Yu, "Quantitative theory of nanowire and nanotube antenna performance," *IEEE Transactions on Nanotechnology*, vol. 5, no. 4, pp. 314–334, 2006.
- [20] G. W. Hanson, "Fundamental transmitting properties of carbon nanotube antenna," *IEEE Transaction on Antennas and Propagation*, vol. 1, pp. 3426–3435, 2005.
- [21] E. Amram Bengio, D. Senic, L. W. Taylor et al., "Orloff and Matteo Pasquali, "High efficiency carbon nanotube thread antennas,"" *Applied Physics Letters*, vol. 111, 2017.
- [22] S. D. Keller, A. I. Zaghoul, V. Shanov et al., "Design and development of carbon nanotube antennas," in *Nanotube Superfiber Materials*, pp. 489–509, Science, Manufacturing, Commercialization Micro and Nano Technologies, 2019.
- [23] B. H. Bejaxhin, G. Paulraj, and M. Prabhakar, "Inspection of casting defects and grain boundary strengthening on stressed Al6061 specimen by NDT method and SEM micrographs," *Journal of Materials Research and Technology*, vol. 8, no. 3, pp. 2674–2684, 2019.
- [24] S. Vellaiyan, A. Subbiah, S. Kuppasamy, S. Subramanian, and Y. Devarajan, "Water in waste-derived oil emulsion fuel with cetane improver: formulation, characterization and its optimization for efficient and cleaner production," *Fuel Processing Technology*, vol. 228, p. 107141, 2022.
- [25] K. Matsuda, "Fundamental optical properties of carbon nanotubes and graphene," *Carbon Nanotubes and Graphenes for Photonic Applications*, vol. 1, pp. 3–25, 2013.
- [26] A. Behnam, A. Biswas, G. Bosman, and A. Ural, "Temperature-dependent transport and 1/f noise mechanisms in single-walled carbon nanotube films," *Physical Review B*, vol. 81, no. 12, 2010.
- [27] C. Peigney, E. Laurent, R. R. Flahaut, A. R. Bacsa, and A. Rousset, "Specific surface area of carbon nanotubes and bundles of carbon nanotubes," *Carbon*, vol. 39, no. 4, pp. 507–514, 2001.
- [28] P. G. Collins, M. S. Fuhrer, and A. Zettl, "1/f noise in carbon nanotubes," *Applied Physics Letter*, vol. 76, no. 7, 2000.
- [29] A. A. García Blanco, J. V. Rocha, J. F. Múnera, M. Nazzarro, G. Zgrablich, and K. Sapag, "A study of the adsorption

properties of single walled carbon nanotubes treated with nitric acid,” *Adsorption Science and Technology*, vol. 29, no. 7, pp. 705–722, 2011.

- [30] Y. Devarajan, B. Nagappan, G. Choubey, S. Vellaiyan, and K. Mehar, “Renewable pathway and twin fueling approach on ignition analysis of a dual-fuelled compression ignition engine,” *Energy & Fuels*, vol. 35, no. 12, pp. 9930–9936, 2021.