

Design, Fabrication and Testing of Biogas Stove for ‘Areke’ Distillation: The case of Arsi Negele, Ethiopia, Targeting Reduction of Fuel-Wood Dependence

Shewangizaw W. Demissie
School of Mechanical Engineering
Jimma University
Jimma, Oromia –ET, Ethiopia

Venkata A.Ramayya
School of Mechanical Engineering
Jimma University
Jimma, Oromia –ET, Ethiopia

Derese T. Nega
Department of Physics
Jimma University
Jimma, Oromia –ET, Ethiopia

Abstract— In Ethiopia, in addition to the already existing burden on natural resource imposed by the use of traditional biomass for cooking, the processing and production of alcoholic beverages such as local liquor (‘Areke’), local beer (‘Tela’), ‘Korefe’, ‘Borde’ and others place further threat on the forest. Research on potential assessment of biogas to replace the fuel wood consumption has revealed a promising result of biomass dependence reduction. This study showed that if sustainable biogas energy development is implemented, the dependency on fuel wood can be reduced by 27.7% by reducing 32, 763.70 tons of GHGs emission annually in Arsi Negele alone. Therefore, through this study analytically designing the biogas stove for minimum gas consumption and high efficiency, fabrication and experimental testing is done. Additionally the economic projection of biogas utilization in Areke distillation is evaluated and found to be economically feasible with a payback period of a little over three years. The overall efficiency of the stove evaluated through Water Boiling Test (WBT) is found to be 54.8% , 43.6% at higher flame intensity and relatively lower flame intensity respectively. The stove showed a remarkable reduction in time taken for distilling a pot of distill and which is nearly half of the time it took to distill a pot of distilland using wood. The new stove consumes only 0.994 m³ of biogas while the biogas stove tested before which is ordinary biogas stove for general cooking purpose consumes 2.088 m³ to distill a pot of distilland. Even though the initial investments are high, with the conducive environment available for biogas production at Arsi Negele, using biogas for Areke distillation without any doubt can be a viable option for eco-friendly and economically feasible production of traditional Areke. Therefore, any concerned government and non-government body should act in promoting either by piloting or partly funding the installation while putting the sense of ownership in the mind of the users.

Keywords— *Areke distillation, Biogas stove, eco-friendly, deforestation, overall efficiency*

I. INTRODUCTION

Widely practiced traditional Areke distillation all over the country in Ethiopia is imposing socio-economic and environmental impact. As a result of these practice, even protected forests are stripped and deforestation is escalating rapidly because Areke production is currently powered by fuel wood from nearby forest. For Ethiopia, given resource potential, biogas is one of the promising clean energy for

households. The sole technology for biogas production in Ethiopia so far is anaerobic digestion/fermentation that based on animal residue which Ethiopia is endowed with huge potential.

According to Ethiopia’s Climate Resilience Green Economy Strategy, replacing open fire stoves with stoves that need only half as much fuel wood or stoves that use other fuels holds an estimated 20% of Ethiopia’s total potential for emission reduction. On top of greenhouse gas emissions from deforestation it would have an impact by;

- Increasing rural household income by 10%.
- Creating many more jobs in making stoves.
- Reducing severe health risks from smoke inhalation (“black carbon”)
- Also decrease hours spent on gathering fuel wood (typically by women, Girls and children, often in risky areas).

Thus, this work depicts the feasibility of using Areke distilling stove through the use of biogas as a feed stock for reduction of fuel wood dependence of Areke distillation.

II. DESIGN OF BIOGAS STOVE

A. Injector

An injector needs to be carefully designed and positioned in order to control the amount of gas and air used by a burner. The size and shape of the injector orifice control the gas flow rate and hence heat input for a given gas composition and supply pressure [1].

B. Discharge from an orifice

In physical terms, an injector uses to convert potential energy from high pressure gas supply in to the kinetic energy of an emerging gas jet. Mathematically, therefore, by conservation of energy and assuming no losses at the nozzle, we have (per unit mass):

$$\frac{1}{2}v^2 = gh \quad \text{Or} \quad \dot{V} = A_j \sqrt{2gh} \quad (1)$$

Where:

\dot{V} - Volumetric gas flow rate from the orifice (m³ s⁻¹)

A_j - jet area (m²)

g -acceleration due to gravity

h -column of gas required to exert gas pressure at the orifice

Gauge pressure is given as:

$$p = h\rho_g g \quad (2)$$

Where; ρ_g = density of biogas (1.15kg/m³)

From equation 1 and 2

$$Q = 0.046101A_j \sqrt{\frac{p}{s}} \quad (3)$$

Where: Q = gas flow rate (m³ h⁻¹)

A_j = area of orifice (mm²)

p = gas pressure before orifice (10mbar)

s = specific gravity of biogas gas (0.94)

Relative density (specific gravity) of methane and Carbon dioxide (with air density=1 kg/m³) is 0.554 kg/m³ and 1.519 kg/m³ respectively [2]. Volumetric content of biogas is 60% methane and 40% carbon dioxide; based on the volumetric content specific gravity of biogas expressed as:

$$s = (0.554 \text{ kg/m}^3 * 60\%) + (1.519 \text{ kg/m}^3 * 40\%) = 0.94 \text{ kg/m}^3$$

In practice, the flow of gas after orifice is less than before orifice because of frictional losses and the vena-contract effect. It is usual to represent these two terms as a coefficient of discharge, C_D such that:

$$Q = 0.046101C_D A_j \sqrt{\frac{p}{s}} \quad (4)$$

C_D = coefficient of discharge for the orifice is taken 0.94 from [2]

C. Biogas combustion

The combustion of gas involves mixing of air with fuel gas, adding heat in the form of a pilot and burning the resultant air-gas mixture. The chemical reaction of combustion of biogas (containing 60 % methane and 40 % carbon dioxide) and air (oxygen and nitrogen) mixture is shown below:

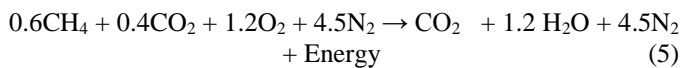

Thus, one volume of biogas requires 5.7 volumes of air or the stoichiometric requirement is 1/ (1+5.7) = 0.149, i.e., 14.9 % volume of biogas is required in air.

Characteristics of biogas important from the viewpoint of designing an efficient stove or a lamp are mentioned in table I.

TABLE I: PROPERTIES OF BIOGAS RELEVANT FOR DESIGNING A STOVE OR A LAMP (SOURCE: D.GUPTA 2009)

Property	Value
Methane and carbon dioxide content	60 % and 40 %
Calorific value	22 MJ/m ³
Specific gravity	0.940
Density	1.2kg/m ³
Flame speed factor	11.1
Air requirement for combustion	5.7 m ³ /m ³
Combustion speed	40 cm/sec.
Inflammability in air	6-25 %

Biogas will burn over a narrow range of mixtures from approximately 9% to 17% of biogas in air. If the flame is 'too rich', i.e., has too much fuel, then it will burn badly and incompletely, giving carbon monoxide (which is poisonous) and soot (carbon particles). Burners are usually run "slightly

lean", with a small excess air, to avoid the danger of the flame becoming rich [3].

In partially aerated burners, air is mixed with the gas before it is burnt. The amount of primary air added to the gas before the flame, varies depending on the design of burner, but is usually around 50% of the total air requirement.

D. Aerated flame

As gas comes out through injector, primary air is entrained into the stream and is mixed in the mixing tube with the gas before it comes out of the burner port. The unburned gas is heated up in an inner cone and starts burning at the flame front. The cone shape is a result of laminar flow in a cylindrical mixing tube, the mixture at the center of the tube is moving at a higher velocity than that at the outside. The main combustion zone is where the gas burns in the primary air and generates the heat in the flame. The Outer mantle of the flame is where combustion is completed with the aid of the secondary air that is drawn into the flame from the sides.

The combustion products (carbon dioxide and steam) are at a high temperature, so rise vertically away from the flame, transferring heat to the air close to the top of the flame. It is this air moving vertically away that draws in the cooler secondary air to the base of the flame. The size of the inner cone depends on the primary aeration. A high proportion of primary air makes the flame much smaller and concentrated, giving higher flame temperatures [3].

E. Air entrainment

The mechanism of air entrainment has been studied experimentally and theoretically for many years, and is of vital interest to the domestic aerated burner designers because the quantity of primary air taken up has a considerable effect on burner port design requirements, flame stability, shape and temperature, and, ultimately, the design of the combustion chamber itself.

The gas emerging from the injector enters the end of the mixing tube in a region called the "throat". The throat has a much larger diameter than the injector, so the velocity of the gas stream is much reduced.

The velocity v_j of the gas in the orifice is given by:

$$v_j = \frac{Q}{3.6 \times 10^{-3} A_j} \text{ ms}^{-1}, \text{ with } Q \text{ in m}^3\text{h}^{-1} \text{ and } A_j \text{ in (mm)}^2 \quad (6)$$

Velocity reduction in the throat is expressed as:

$$v_t = v_j \frac{A_j}{A_t} \quad (7)$$

Ignoring the vena contractor effect and friction loss the gas pressure just after the nozzle then becomes:

$$P_t = P_j - \rho \frac{v_j^2}{2g} \left[1 - \left(\frac{d_j}{d_t} \right)^4 \right] \quad (8)$$

The value of P_j is around atmospheric pressure as the throat is open to the air. This pressure drop is sufficient to draw primary air by the air inlet parts to mix with the gas in the mixing tube [3].

The primary aeration depends on the entrainment ratio (r) which is determined by the area of the throat and the injector.

F. Throat size

The flow rate of the mixture in the throat Q_m is the sum of flow rate of the gas and the entrained air.

$$Q_m = Q_{gas}(1 + r) \quad (9)$$

Where r is the entrained air to gas volume ratio, then: $r = \frac{Q_{air}}{Q_{gas}}$

The pressure drop due to the flow of the mixture down the mixing tube should be checked, by first calculating the Reynolds number.

$$Re = \frac{\rho_m d_t v_t}{\mu} = \frac{4\rho_m Q_m}{\pi \mu_m d_t} \quad (10)$$

Where ρ_m and μ_m are the density and viscosity of the mixture specified as follows:

$$\begin{aligned} \rho_m &= 1.15 \text{ kg/m}^3 \text{ And} \\ \mu_m &= 1.71 \times 10^{-5} \text{ pa s At a temperature of } 30^\circ\text{C} \end{aligned}$$

The pressure drop ΔP is given by:

$$\Delta P = \frac{f}{2} \rho_m v_t^2 \frac{l_m}{d_t} = \frac{f}{2} \rho_m \frac{16 Q_m^2}{\pi^2 d_t^5} l_m \quad (11)$$

Where:

$$f = \frac{Re}{64}, \text{ when } Re < 2000 \text{ and } f = \frac{0.316}{Re^{0.25}} \text{ when } Re > 2000 \quad (12)$$

The pressure drop should be much less than the driving pressure. Most burners are designed to have a throat that gives aeration greater than optimum, with a device for restricting the air flow, so the optimum aeration can be set for a given situation.

G. Mixing tube

The mixing tube and diffuser as one unit and obtained by experiment the effect on air entrainment of mixing tube length both downstream and upstream of the throat from practical result the distance from the throat entrance to the injector should be about 2 to 2.5 times the throat diameter, and that mixing tube length should be about 10 to 12 throat diameters [1]

H. Burner ports

The big advantage of a gas burner is that the heat can be directed to where it is needed, by designing the burner properly.

When a biogas/air mixture has ignited, the flame front produced propagates through the remaining unburnt gases at a rate dependent on the mixture composition, pressure and temperature. The burning velocity is a fundamental property of the mixture and is linked to the overall chemical reaction rate in the flame. Burning velocity is defined as the velocity normal to the flame front, relative to the unburnt gas, at which an infinite one dimensional flame propagates through the unburnt gas mixture. Biogas has a stoichiometric flame speed of only 0.25 m/s burning velocity [3]

The mixing supply velocity v_p is given by [3]:

$$v_p = \frac{Q_m}{A_p} \ll 0.25 \text{ ms}^{-1} \quad (13)$$

$$\text{Where: } A_p \text{ (the total burner port area in m}^2\text{)} = n_p \frac{\pi d_p^2}{4} \quad (14)$$

n_p - Number of ports

d_p - Diameter of each port in m

III. METHODOLOGY AND MATERIALS

A. Analytically determining power required

Considering the efficiency of the traditional stove which is not greater than 10% [4] the power required for the process can be determined using the general equation of efficiency. With a calorific value (CV) of wood at 19.45 MJ/Kg [5] and specific fuel consumption of the process 1.007Kg of wood per Kg of distilland [6]. As the experimental test result on the study conducted by Girma Gezahagn in order to distill in average 45.033Kg of distilland it took about 760min or 12.67hours [6].

To determining the power required could be first calculating the rate at which firewood is being burned as $(1.007 \times 45.033) / 12.67 = 3.58 \text{ Kg/hr}$ then using the same values of efficiency and calorific value of wood we can come up with the power.

$$\text{Efficiency} = \frac{\text{Power out put}}{\text{Power input}} \quad (15)$$

$$\text{Efficiency of traditional stove} = \frac{\text{Power out put}}{\text{CV of wood} \times \text{mass of wood/hr}} \quad (16)$$

$$\text{Power out put required} = 1.547 \text{ KW}$$

Therefore, Areke distillation process requires or took power of 1.547KW.

B. Determination of Biogas required

In determining the biogas flow rate to meet the power input required for the process knowing the power required of the process being 1.547KW, calorific value of biogas 22MJ/m³[7] and setting optimum biogas stove efficiency of 50% can be calculated as follows;

$$\text{Efficiency of biogas stove} = \frac{\text{Power out put}}{\text{CV of biogas} \times Q_{\text{biogas}}} \quad (17)$$

$$Q_{\text{biogas}} = 0.504 \text{ m}^3/\text{hr}$$

In other way considering the efficiency of the traditional stove which is not greater than 10% [4] the energy required for the process can be determined using the general equation of efficiency. With a calorific value (CV) of wood at 19.45 MJ/Kg and specific fuel consumption of the process 1.007 Kg of wood per Kg of food cooked [6]. The energy required to cook one kilogram of food will be:

Efficiency of traditional stove = energy input required / (CV of wood * mass of wood/mass of food)

$$\text{Efficiency of tradi. stove} = \frac{\text{Energy out put}}{\text{CV of wood} \times \frac{\text{mass of wood consumed}}{\text{kg of distilland}}} \quad (18)$$

$$\therefore \text{Energy out put} = 1.567 \text{ MJ/kg of distilland}$$

The energy required to cook one kilogram of food is found to be 1.567 MJ with this result we can determine the volume of gas required as an input with an optimum biogas stove efficiency of 50% [7] to achieve the energy required for the process with a Wobe number of the biogas to be 22MJ/m³[7] as follows.

$$\text{Efficiency of biogas stove} = \frac{(\text{Energy out put})(\text{kg of distilland})}{(\text{CV of biogas}) \times \text{Volume of biogas}} \quad (19)$$

$$\therefore \text{Volume of biogas} = 0.142 \text{ m}^3/\text{kg of food cooked}$$

From the experimental test result on the study conducted by Girma Gezahagn in order to distill in average 45.033Kg of distilland it took about 760 min or 12.67 hours[6]the amount of distilland distilled per hour will be 45.033/12.67 = 3.554 Kg of distilland / hour. Therefore from this it is simple to calculate the gas required per hour as 0.142 * 3.554 = 0.504 m³/hr.

C. Hypotheses

From the results of calculations made above and information gathered from literatures the potential of biogas in reducing firewood dependence of Areke production can be evaluated. Biogas flow rate required for the process of Areke production at 0.504m³/hr and biogas production potential of Areke distillers at 3m³ the amount of time the biogas can serve the Areke production is 3/0.504 =5.95hours. However, the traditional stove burns 5.95 * 3.58 = 21.3Kg of fire wood to perform the same process. Therefore, this 21.3Kg of firewood that could have been burned can be replaced by the biogas and it accounts for 27.7% of the total 76.98Kg/day of firewood consumption.

D. Analytical Design Calculations of stove parameters

i. Sizing injector or orifice jet

The ejector or orifice area was calculated by using “(1)”

$$d_o = \sqrt{\frac{Q}{0.0361 \times C_D}} \times \sqrt[4]{\frac{s}{P}} = 2.16\text{mm} \quad (20)$$

Where: Q (gas flow rate) = 0.504m³/hr

The area of orifice jet is determined as:

$$A_j = \frac{\pi d^2}{4} = 3.7 \times 10^{-6} \text{m}^2$$

The velocity of the \s in the orifice jet is:

$$v_j = \frac{Q_{\text{biogas}}}{A_j} = 38\text{ms}^{-1}$$

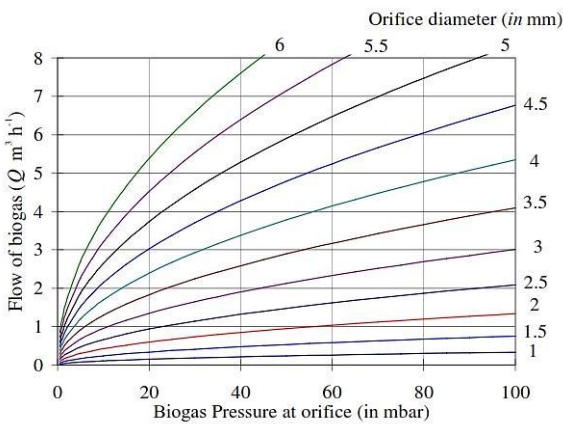

Fig. 1. Graph of: $Q = 0.046101C_D d_j^2 \sqrt{\frac{P}{s}}$

ii. Determining the throat size

From the composition of biogas, the stoichiometric air requirement is 5.7, then the entrainment ratio (r) is $r = 5.7/2 = 2.85$. The flow rate of the biogas and air mixture at optimum aeration is given by “(9)”; $Q_m = 5.25 \times 10^{-4} \text{m}^3 \text{s}^{-1}$.

Throat diameter d_t is calculated using Prig’s formula including orifice diameter as follows [3]

$$d_t = \left(\frac{r}{\sqrt{s}} + 1\right) d_j = 8.16\text{mm} \quad (21)$$

However, it is better to use the stoichiometric value of primary air of 5.7 directly rather than using $r = 2.85$ to get better aeration and control using primary air flow adjuster. So, the better diameter of throat will be [3] $d_t \approx 14.2\text{mm}$. Then the throat area becomes 158.4mm² or $1.58 \times 10^{-4} \text{m}^2$ “The primary air inlet port must have an area similar to that of the throat” [3].

The gas pressure in the throat can be calculated using “(8),” $P_t = 99910 \text{Pasical}$. The value of P_j is 10^5Pa as the throat is open to the air. This pressure drop is sufficient to draw primary air by the air inlet parts to mix with the gas in the mixing tube [3].

Calculating the Reynolds number should be used to check the pressure drop due to the flow of biogas and air mixture in the mixing tube using “(10),” is $R_e = 3097.5$. Thus, $R_e < 2000$, so the friction loss is calculated using “(12),” is $f = 0.04236$ and pressure drop ΔP could be calculated using “(11)” is $\Delta P = 2.79 \text{ Pasical}$. So that, the pressure drop is much lower than the driving pressure/pressure in the throat.

iii. Burner port design

Biogas has a stoichiometric flame speed of only 0.25 m/s burning velocity [3]. The mixture supply velocity (v_p) using “(13)” is $v_p \ll 0.25 \text{ms}^{-1}$.

The total burner port area will be chosen as:

$$A_p > \frac{Q_m}{v_p} \gg 0.0021 \text{m}^2 \quad (22)$$

‘Fulford (1996) and Itodo (2007) in their study used 5mm and 2.5mm diameter holes respectively. However, a problem of flame lift was recorded at a diameter less than 2.5 mm’[8]. Using 3 mm port diameter to minimize the problem of flame lift, the total number of required ports will be:

$$n_p = \frac{4A_p}{\pi d_p^2} = 308 \text{ ports}$$

“Using flame stabilization, literature suggested it is possible to reduce this number of burner ports, by up to 1/5, so 62 holes are sufficient [3].”

Using 62 holes, with 5mm gaps between holes, arranged in a circular pattern, gives a total circumference of $62 \times (3+5) = 496\text{mm}$. The hole centers are then placed around a circle of diameter $496\text{mm} = \pi \times D \geq D \approx 157\text{mm}$.

E. Fabrication of stove

The biogas stove for Areke distillation was fabricated based on the values of stove parameters obtained on the analytical design calculation made in earlier sections of this report. The very important parameters that are taken in to consideration during the fabrication process of the stove are listed below.

- a) Injector or orifice diameter
- b) Throat diameter
- c) Mixing tube length
- d) Primary air inlet area
- e) Burning port: number of holes and their diameter
- f) Burner manifold diameter and height

The parameters listed above are mainly linked to the burner part of the stove. But other more considerations were also taken into consideration during the fabrication of the stove frame. Considerations such as the gap between the burner top and the vessel are made to be adjustable through a mechanism that helps to perform the task. The stove is also equipped with an access to control the primary air which is a sliding type. The figure bellows are detailed fabrication drawing:

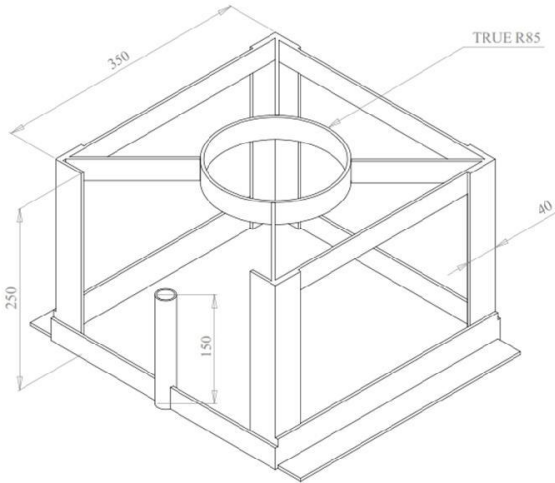

Fig. 2. Stove Frame 3D drawing

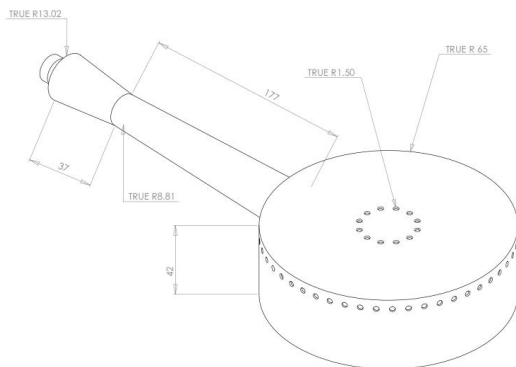

Fig. 3. Biogas burner 3D drawing



Fig. 4. The photograph of assembled stove

F. Experimental test

In order to evaluate the performance of the stove and to check whether or not it will serve its desired purpose two types of tests have been conducted which are water heating test to easily or simply calculate how much of the heat of the combustion goes to the water being boiled to evaluate the thermal efficiency of the stove and actual function test (Controlled Cooking Test) means test run while Areke is actually being distilled by using the newly constructed biogas stove.



Fig. 5. Experimental setup

i. Water boiling test

Due to the major limitation of getting enough time and biogas to make the through waterboiling test what has been done in this experiment is bringing a specified mass of water from its initial temperature to its boiling point and check how much gas was consumed. Which means from complete water boiling test performing only the High power phase to easily or simply calculate how much of the heat of the combustion goes to the water being boiled. And from the measurements obtained the simple thermal efficiency of the stove was calculated using the following equation[9].

$$\text{Efficiency}_{\text{overall}} = \frac{M_w \times C_{pw}(T_b - T_i) + M_v \times C_{pv}(T_b - T_i)}{V_{bg} \times CV_{bg}}$$

Where:

M_w – mass of water boiled

C_{pw} – Specific heat capacity of water = 4.2KJ/Kg.⁰C

C_{pv} – Specific heat capacity of Stainless steel = 0.5 KJ/Kg.K

CV_{bg} – Calorific value of fuel (biogas) = 22 MJ/m³

V_{bg} – Volume of biogas consumed

M_v – Mass of the vessel

T_i – Initial temperature of water

T_b – Boiling temperature of water at Jimma approximated as = $(100 - \frac{\text{Altitude}}{300})^{\circ}\text{C}$ where Jimma altitude is 1700 to 1800m above sea level.

In the complete form of the above equation the mass of steam evaporated and latent heat of the boiling water is not considered due to the above mentioned limitations since the test was made until the water reaches its boiling point.

With above consideration the performance of the biogas stove was tested under the following conditions:

1. Efficiency and boiling rate at various operating pressure
2. Efficiency and boiling rate at various volume of water
3. Efficiency and boiling rate at various flame intensity and volume of water
4. Efficiency and boiling rate of the stove with and without lead vessel

ii. Controlled Cooking Test for Areke Distillation

To conduct this test first I was expected to contact an experienced traditional Areke distiller. But it was not an easy task to find one. Because most of them has stopped Areke distilling but still they are selling Areke by bringing it from Gojam. For these reason I was having hard time of finding someone who is currently distilling Areke. But one lady was willing to do it if I provide the necessary supplies and I complied.

In the process of controlled cooking test the weight of the pot, the weight of the distilland cooked, the amount of Areke distilled and the time taken to complete has been measured. The operating pressure and the amount of biogas consumed were computed from the design considerations. Three distillations were performed during the experimental test.

G. Materials

In this study, even though there were a lot of limitations, several materials have been utilized to make it conclusive as much as possible. To mention the materials used biogas digester from Jimma Degitu Hotel, 21 Kg cylinder gas to replace the biogas digester, the newly constructed biogas stove, pressure gauge, thermometers to read temperatures, stop watch to count time, weighing balance to measure the weight of the distilland, the pot and vessels used in the experiment, the entire setup of traditional Areke distillation and various size stainless steel vessels.

IV. RESULT AND DISCUSSION

In this section the results obtained from the analytical design and experiment presented and discussed against literatures and previous studies. Since the results of the analytical design calculations are already provided in the previous section here only the summery is presented. But the results of the experiment is elaborated in detail in this section and discussed.

A. Results of analytical design

The stove is constructed with the fabrication values listed in the table II and tested if it gives the result it is required from it for the specific purpose it is designed for.

TABLE II: THE RESULTS OF THE ANALYTICAL DESIGN CALCULATION ARE PRESENTED BELOW AS FOLLOWS:

S.No.	Parameters	Results	Fabrication values
1.	Design biogas flow rate	0.504 m3/hr	
2.	Design Injector diameter	2.16 mm	2.5 mm taken for stove fabrication
3.	Throat diameter	14.67mm	17 mm
4.	MIXING tube length	22cm	210 mm
5.	Burner port diameter	3mm	3 mm
6.	Burner manifold diameter	127.3mm	130 mm
7.	Number of burner ports	62	62
8.	Primary air inlet area	191.6mm2	191.6 mm2

B. Results of Experimental test

The experimental tests which are the water boiling and controlled cooking tests conducted as it was stated in the methodology of the study are presented below.

i. Water Boiling Test

In this water boiling test experiment, the maximum overall efficiency obtained was 54.8 % at higher fire intensity while 8 liters of water were being boiled and 43.6 % at relatively lower fire intensity while 10 liters of water were being boiled.



Fig. 6. During water boiling test

Water boiling rate at different operating pressure with water volume of 2.4 litter and the weight of the vessel 1.5kg was also conducted. The result obtained shows that as the operating pressure drops , the boiling rate were also drops similarly. The result is graphically presented below in “Fig. 7,”.

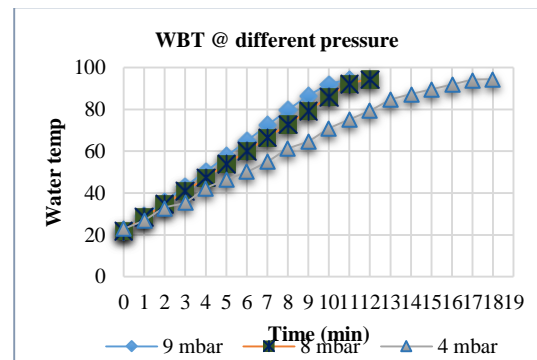

Fig. 7. Boiling rate at different pressure

TABLE III: DATA OF WBT AT VARIOUS OPERATING PRESSURE AND SAME VOLUME OF WATER

Time (Min)	Test one		Time (min)	Test two		Time (min)	Test Three	
	milibar	°C		milibar	°C		milibar	°C
0	9	22	0	8	22	0	4	22.8
1	9	29.1	1	8	28.5	1	4	27
2	9	36.1	2	8	34.7	2	4	32.9
3	9	43.2	3	8	40.9	3	4	35.5
4	9	50.4	4	8	47.4	4	4	42.2
5	9	57.6	5	8	53.8	5	4	46.4
6	9	65	6	8	60.1	6	4	50.1
7	9	72.4	7	8	66.5	7	4	55
8	9	79.7	8	8	72.8	8	4	61.1
9	9	86.5	9	8	79.3	9	4	64.8
10	9	91.9	10	8	85.9	10	4	70.8
10:30	9	94.4	11	8	92.1	11	4	75.2
			11:18	8	94.3	12	4	79.4
						13	4	84.5
						14	2	87.3
						15	2	89.6
						16	2	91.9
						17	2	94.1
						17:10	2	94.5

The table above shows that the data collected during WBT at different pressure. Efficiency of the stove while 2.4 litter of water boiled at different operating pressure found to be efficiency rises with the rise of the operating pressure.

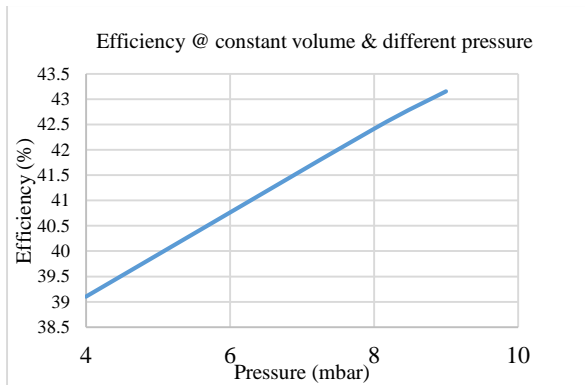

Fig. 8. Efficiency at different pressure

The evaluation of water heating rate while the vessel is closed and opened also conducted in this experiment and the result obtained indicated that the rate of water heating is extended when the vessel is opened. The “fig. 9,” below shows the variation of water heating rate with the vessel closed and open.

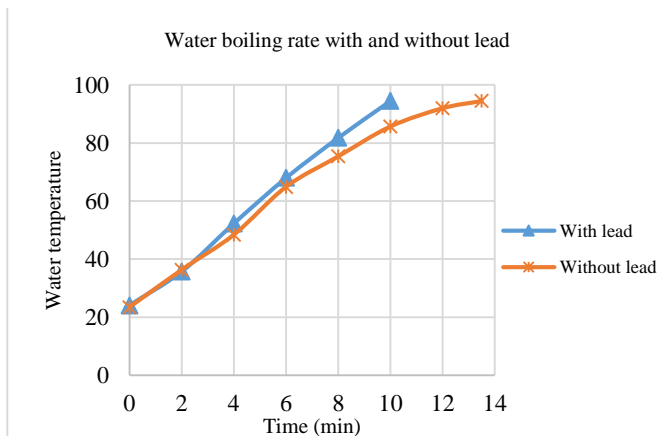

Fig. 9. Water boiling rate with the vessel closed and open

TABLE IV: WATER BOILING RATE AT LOWER VOLUMENED

Time	Volume of Water (Liters)				
	1Lit	1Lit	2 Lit	2Lit	1Lit
	Temperature rise of water (0C)				
0	23.1	24	24.1	23.4	0
1	32	33.2	28	28	1
2	39.9	42	35.7	34.5	2
3	48	52	42	42	3
4	55.8	61.9	52.3	49.8	4
5	65.4	70.8	63.2	62	5
6	71.5	79.2	68	64.4	6
7	82.9	89.7	77.4	74	7
8	91.6	94.6	81.8	77.7	8
8.3	94.5		83	82.5	8.3
9			91.3	88	9
10			94.5	92.7	10

Table IV above shows the result of the test conducted for vitiation of heating rate for small rise in water volume being boiled at constant operating biogas pressure and the variation of heating rate is found to be small as compared to the heating variation at relatively bigger volume change of water boiled shown in “Fig. 10,”).

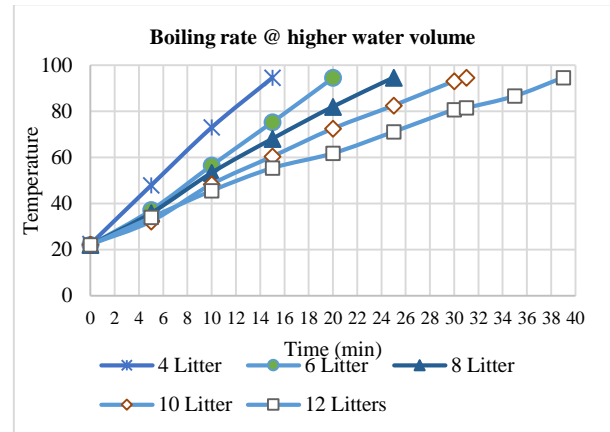

Figure 10. Boiling rate at higher water volume variation

The combined result presented in “Fig. 11,” shows the difference in the variation of heating rate for both small and larger water volume change.

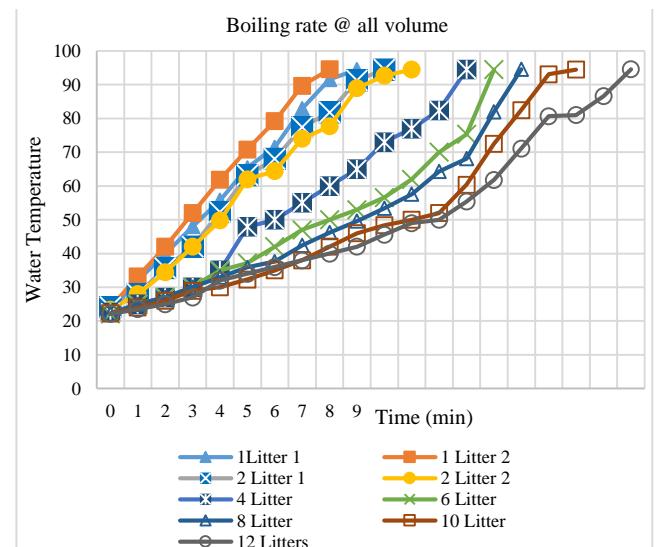

Fig. 11: Boiling rate @ all volume

Variation of the stove efficiency at small change in the volume of water boiled at constant pressure recorded shows that for 1 to 2 litter and 2 to 0.4 litter change in water volume the efficiency increases nearly with the same rate. As a result of this, as the volume of water being heated goes higher the rate at which the efficiency increases goes up. To counter check up to what volume of water the efficiency keep on raising the test continuously.

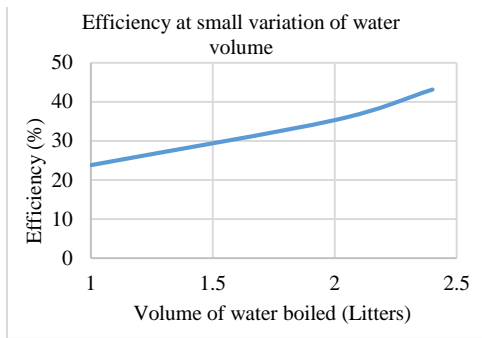

Fig. 12: Efficiency at small variation of water volume

But as it is indicated in the two figures “Fig. 13,” and “Fig. 14,” below the efficiency kept increasing up to 43.6 % until the volume of water heated reaches 10 litter then it starts slowly declining for the test conducted while the intensity of the flame was low. But for the test conducted at relatively higher flame intensity the efficiency was rising and reaches 54.8 % at 8 litters of water and start declining however the efficiency is still higher at 10 and 12 litter with 53.1 % and 51.7% respectively. Theoretical efficiency is had it been the injector diameter of the stove were 2.16mm and actual efficiency is with injector diameter of 2.5mm. “Table V” and “Fig. 15,” shows the variation of the temperature rise of the water at different volume with respect to time.

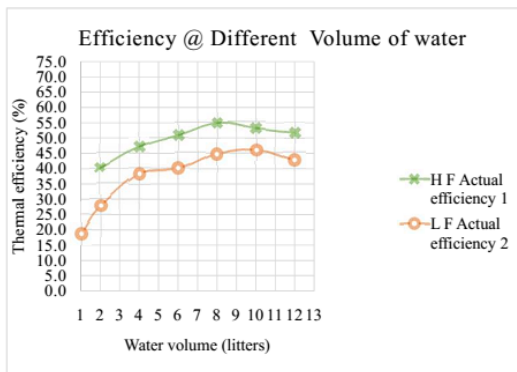

Fig. 13: Efficiency @ different volume of water

Theoretical and actual efficiency of the biogas stove at relatively lower flame intensity.

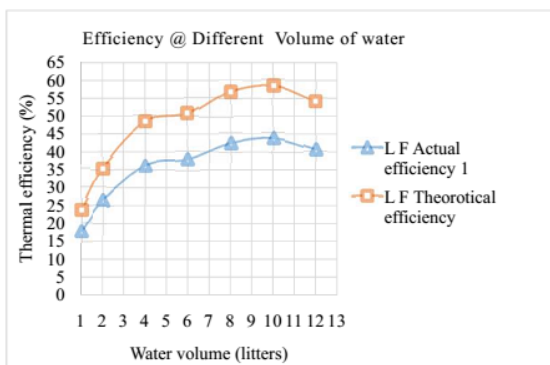

Fig. 14: Efficiency @ different volume of water

The water boiling test conducted at constant pressure with relatively higher flame/fire intensity provides the results in the table below. The diameter of the pot in which the water was boiled is 32 cm and it has a mass of 4.5Kg including the lead.

TABLE V: DATA OF WATER BOILING TEST AT HIGHER FIRE INTENSITY

Time in minuts	Volume of water boiled in liters						
	2	4	6	8	10	12	
	Temperature of water in °C						
0	24.4	24.2	24.2	24	24.2	23.9	
5	75	51.1	46.4	42.4	38.1	36.8	
7.5	94.6						
10	94.6	83.6	70	62	54.2	51.5	
11.5	94.6	94.7					11.5
15	94.6	94.7	94.8	81.3	69.1	64.5	14.6
20	94.6	94.7	94.8	94.7	83.2	73.4	18.6
25	94.6	94.7	94.8	94.7	94.7	83.6	24
29	94.6	94.7	94.8	94.7	94.7	94.7	

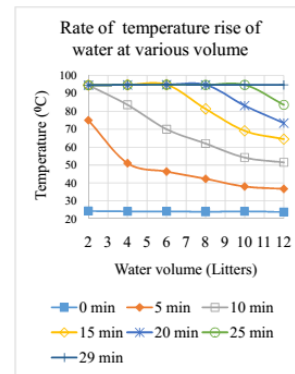

Fig. 15: Water heating rate at various water volume

ii. *Controlled cooking test of Areke distilling*

In this experiment three tests have been conducted. The pot weighs 5.5 Kg and the initial temperature of the distilland was 20.80C. For the first round test initial the pot was put on the stove empty until it warms up then the level to which it heats up was checked by pouring some water in to it. Then the distilland was poured in to the pot and kept open until it boils while it has been steered before the distillation tube is put in place and sealed then left until the distillation is over.

TABLE VI: EXPERIMENTAL RESULTS OF NEW TEST AND TEST MADE PREVIOUSLY

Stove Type	Pressure (mbar)	Time	V _{bg} (M ³)	Mass of distilland (Kg)	Volume of Areke distilled (Liters)
Existing	9	1:42	2.251	15	2
New		1:24	0.8998	8	1
Existing	8.5	1:42	1.972	14	2
New		1:40	1.041	11	1
Existing	8	1:56	2.042	15	2
New		1:52	1.1513	11	1

The combined result presented in “Fig. 11,” shows the difference in the variation of heating rate for both small and larger water volume change. The volume of gas consumes to distill one litter of Areke from the previous study using existing biogas stove without skirt was 1.044 m3 while the new stove took only 0.998 m3. During the test more than one litter Areke could have been distilled if the day for the distilland to be distilled did not extended by two days which affects the alcoholic yield of the distilland said the lady from her experience. The lady added with kind of set up two litters of Areke could have been distilled.

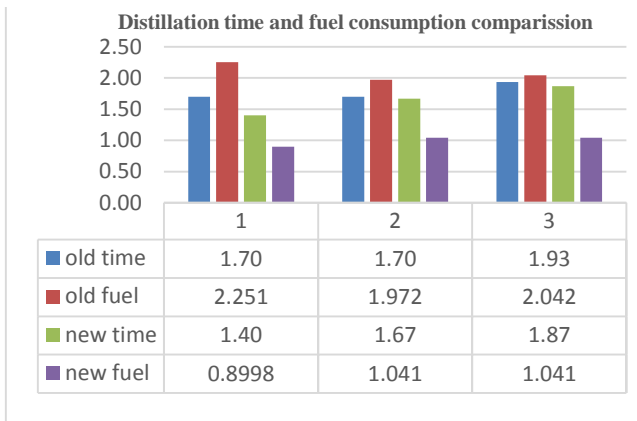

Fig. 16: Distillation time and fuel consumption comparison

C. Performance Evaluation

The experimental test result of the newly designed and fabricated biogas stove showed a remarkable performance as compare to the performances of stoves tested in studies conducted previously. Even though these stoves were not made for the same purpose as the new stove developed through this study they were compare under related test conditions. The result obtained on the testes made on the previous studies showed that the stove which have the best performance was the one with smaller burner port diameter and more number of burner ports [10] and the result obtained in this study also conform the result of the previous study.

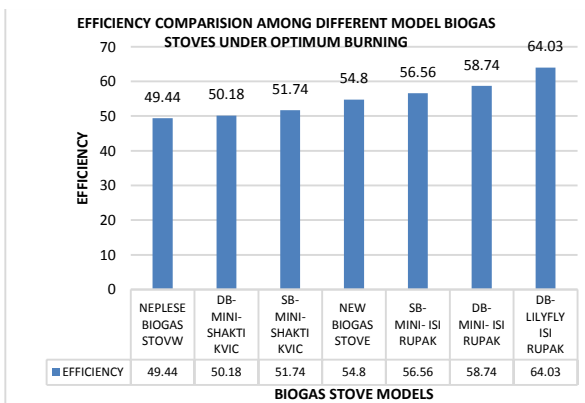

Fig. 17: Overall efficiency under optimum burning condition

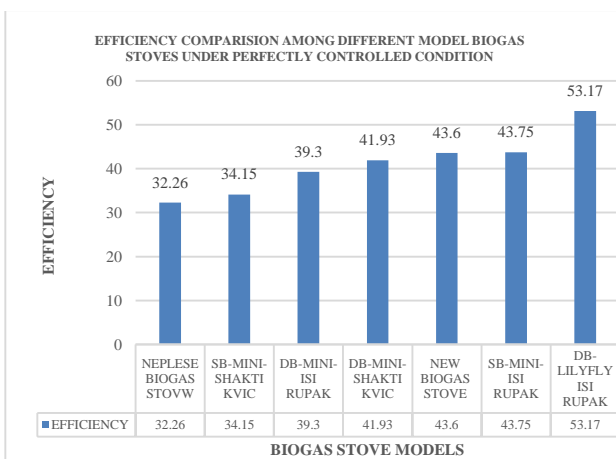

Fig. 18: Overall efficiency under perfectly controlled condition

TABLE VII: SIZE AND NUMBER OF BURNER HOLES OF DIFFERENT TYPES OF BIOGAS STOVES

S.No.	Stove Type	Number of holes			Hole Size (mm)
		Inner	Mid	outer	
1	Double burner "MINI" model (ISI) marked	23	6	6	4.00
2	Single burner "MINI" model (ISI) marked	23	6	6	4.25
3	Double burner "LILYFLY" model (ISI) marked	30	15	15	2.05
4	Single burner "MINI" model (KVIC) marked	20	NA	10	6.05
5	Double burner "LILYFLY" model (KVIC) marked	1	NA	8	6.00
6	Existing biogas stove being used	NA	NA	20	4.50
7	New Areke Distilling biogas stove	50	NA	12	3.00

Additionally in previous study in comparing five different model biogas stoves the time taken by all the stoves to boil one liter of water rests between 9 and 11 minute for both optimum and perfectly controlled air burning conditions [10] while the newly designed and constructed stove in this study took only 7.5 minute to boil two liters of water.

D. GHG Emission Reduction

Mitigation of environmental air pollution that can be reports through this study are minimizing the release of CO and CO₂ from fire wood burning which are the main GHGs and also avoiding the release of CH₄ which is 25 times more pollutant than CO₂ [15]. Because the cow dung which is being dumped at the backyard of traditional Areke distillers which in turn acts as a land fill and have the potential of emitting CH₄.

For wood combustion the CO₂ emission factor reported in previous studies suggested between 1560 – 1620 g/kg (gram of CO₂ per kilo of wood combusted) and others such as CO, CH₄ and NO_x are in the range 19-136 g/Kg, 6-10 g/Kg and 0.05-0.2 g/Kg respectively [12].

In calculating the amount of fire wood consumed and GHGs emitted studies previously conducted indicated that in average 76.98 kg of wood is combusted per production day at Arsi Negelle where they work 5 days per week. There are about 3500 households on the business [11]. From this the considering the worst case scenario of the Areke distillers perform their tasks throughout the year without failure the annual fire wood consumption will be: $W_{annum} = 76.98 \times 5 \times 52 \times 3500 = 70,051,800 \text{ kg/annum}$, The amount of CO released from Areke distillation process at Arsi Negelle only will be $CO_{2\text{emission}} = 111,832,362\text{kg/annum}$, The amount of CO released from Areke distillation process at Arsi Negelle only will be $CO_{\text{emission}} = 5,429,014.5\text{kg/annum}$, The amount of CH₄ released from Areke distillation process at Arsi Negelle is $CH_{4\text{emission}} = 560,414.4\text{kg/annum}$, The amount of NO_x released from Areke distillation process at Arsi Negelle only will be $CO_{2\text{emission}} = 8,756.475\text{kg/annum}$ and the total GHGs emitted for the three pollutants is:

$$GHG_{\text{emission}} = CO_{2\text{emission}} + CO_{\text{emission}} + CH_{4\text{emission}} + NO_{x\text{emission}}$$

$$GHG_{\text{emission}} = 118,280.547.37\text{kg/annum}$$

With the current Areke distillers wood consumption pattern the amount of GHGs emitted to the environment per annum is 118,280.55 tones. With the existing status of the Areke distillers having five (5) cattle in average per household it is possible to replace 27.7 % of the wood by biogas which in turn the GHG. Which will be 32,763,711.621 Kg of GHGs is mitigated at Arsi Negelle.

E. Economics Analysis

In considering the economic benefit and feasibility of utilizing biogas stove for traditional Areke distillation the initial investments required and savings an incomes gained due to utilization of biogas for the process has to compared. In simple economics term the payback period and the Net Present Value (NPV) has to be computed and must give a positive value with in the life of the biogas stove and digester. NPV is useful because it makes to convert future savings cash flows back to “time zero” and it can be calculated the following equation.

$$NPV = S_A \times \frac{1}{(1+r)^n} \tag{23}$$

Where: NPV is Net Present Value, S_A is Annual saving, n is number of years and r is discount rate

Before going into calculating the NPV it required to determine the initial investments needed for utilization of biogas for traditional Areke distillation process such as construction of biogas digester and installation of the system for biogas stove should be determined. Then the savings that will be made and additional incomes that are related with utilization of biogas should be evaluated.

Considering the cost to build 10 m³ biogas digester is 17, 000 ETB and the cost of newly designed biogas stove to be a total of 3000 ETB, the initial expense will be 20, 000 ETB.

Coming to the savings made by using 10m³ biogas digester, the expenses for 27.7 % of the fire wood and the expenses for cleaning the cow dung was considered and also the additional income from selling the digester byproduct as a fertilizer can also be considered.

Saving of wood expenses with the current price of 4 ETB/Kg [14] and a replacement potential of 27.7% will be: 76.98 * 0.277*5*52*4 = 22176.39 ETB.

Saving of cow dung cleaning cost: 50*4*12 = 2400 ETB.

Payment for the person taking care of the digester: 25*365 = 9125 ETB

Running cost such as expenses for 100 liters of water is used and it costs 10 birr the expense per annum will be 20birr/day *365 days/year = 7300 ETB/Annum but if the household is having a water line the expense will be 100 liters/day * 365 days/year = 36, 500 Liters which is 36.5 m³, the expense for water with a rate of 5 birr per m³ is 36.5*5 =182.5 ETB.

TABLE IX: EXPENSES AND SAVINGS IN UTILIZING BIOGAS FOR TRADITIONAL AREKE DISTILLATION

S.No	Activities	Type of Expense of saving	Expense	Savings
1.	Digester	Initial	17,000 ETB	
2.	Stove	Initial	3, 000 ETB	
3.	Cow dung cleaning	operation		2, 400 ETB
4.	Fire wood purchase	operation		22, 176.39 ETB
5.	Digester care taker	operation	9, 125 ETB	
6.	Water for mixing and cleaning	operation	7, 300 ETB	
Total expenses and savings excluding initial investments			16,425 ETB	24, 576.39 ETB
Net saving from using biogas per annum is			8, 151.39 ETB	

With the above considerations the NPV and payback period of biogas utilization was computed in the table below and the result is found to be positive NPV and with a payback period of a little over three years and less than four years which makes it economically feasible.

TABLE VIII: PRESENT VALUES AND CUMULATIVE CASH FLOW

Yea r(n)	Initial and replacement (ETB)	Saving (SA)	Multiplying Factor	PV (ETB)	Cumulative cash flow (ETB)
0	-20000		1	-20000	-20000
1		8151.39	0.87	7088.17	-12911.83
2		8151.39	0.76	6163.62	-6748.21
3		8151.39	0.66	5359.67	-1388.54
4		8151.39	0.57	4660.58	3272.04
5		8151.39	0.50	4052.68	7324.72
6		8151.39	0.43	3524.07	10848.79
7		8151.39	0.38	3064.41	13913.20
8		8151.39	0.33	2664.70	16577.91
9		8151.39	0.28	2317.13	18895.04
10	3000	5151.39	0.25	1273.34	20168.39
11		8151.39	0.21	1752.09	21920.47
12		8151.39	0.19	1523.55	23444.03
13		8151.39	0.16	1324.83	24768.85
14		8151.39	0.14	1152.03	25920.88
15		8151.39	0.12	1001.76	26922.64
16		8151.39	0.11	871.10	27793.74
17		8152.39	0.09	757.57	28551.30
18		8153.39	0.08	658.84	29210.14
19		8154.39	0.07	572.97	29783.11
20		8155.39	0.06	498.30	30281.41

The NPV and payback period of biogas utilization was computed in “Table VIII” above considering a discount rate (r) of 15% and annual saving of 8, 151.39 ETB using “(23)”. The result is found to be positive NPV and with a payback period of a little over three years which makes it economically feasible. “Fig. 19,” shows as the NPV is positive and “Fig. 20,” which the cumulative cash flow diagrams shows that the compound payback period is a little over four years.

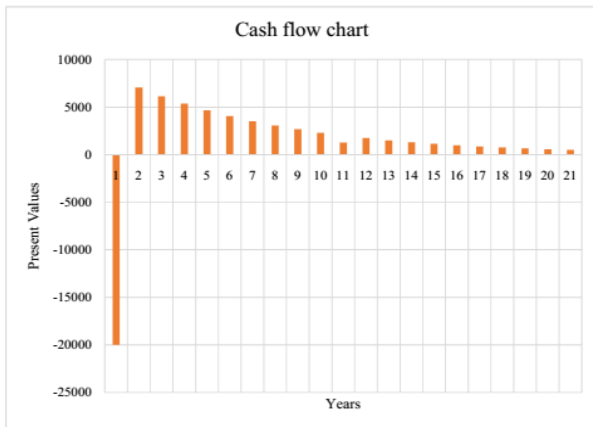

Fig. 19: Cash flow chart for Present values of the savings

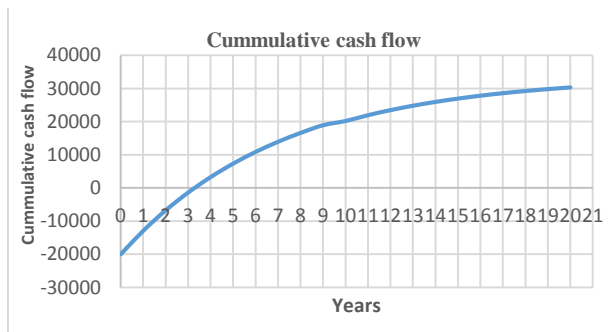

Fig. 20: Cumulative cash flow chart

V. CONCLUSIONS

The primary concern of this study was designing, manufacturing and evaluating the performance of a biogas stove specifically for traditional Areke distillation purpose targeting the assessment of the potential in reduction of fire wood dependence and GHG emission and also the cost benefit analysis of the biogas utilization was carried out.

The heat distribution potential of the burner can be maximized by improving the manifold diameter, number of flame port and flame port diameter. Therefore, as per the analytical design the new stove has burner port diameter of 3 mm and 62 holes while the manifold diameter is 130 mm. The frame of the stove is made from angle iron, flat iron and square pipe and it have a mechanism to help adjust the gap between the pot and burner for better control of the process temperature. From the water boiling test conducted up to 54.8 % overall efficiency at higher flame intensity was obtained and at a relatively lower flame intensity the overall efficiency obtained was 43.6 %. During the controlled cooking test the lady witnessed that with the time it took to distill two round of pot using biogas stove only one pot could have been distilled with fire wood. In addition to the time reduction the biogas stove did not need continuous tending of fire which makes it by far better than using fire wood. However it is advisable to use the biogas in an evenly spreading utilization schedule in the 24 hours period for better performance operation at constant pressure since the gas generation is spread in 24 hours.

This study also showed a GHG emission reduction potential of up to 32,763.7 tones and attractive economic feasibility with positive NPV and payback period of less than four years. Even though the initial investments are high, with the conducive environment available for biogas production at Arsi Negele using biogas for Areke distillation without any doubt can be a viable option for eco-friendly and economically feasible production of traditional Areke distillation.

ACKNOWLEDGMENTS

This work was supported by the Jimma University Institute of Technology. The support of Arsi Negele Administrators and Jimma Degitu Hotel for Biogas Testing is gratefully acknowledged.

REFERENCES

- [1] H. R. N. JONES, "Domestic Gas Burner Design," 2005, p. 208.
- [2] H. R. N. JONES, "The Application of Combustion Principles to Domestic Gas Burner Design," 2005, p. 42.
- [3] "Biogas Stove Design," no. August, 1996.
- [4] H. Lindfors, "Household Biogas Digester In Rural Energy Production Case comparison in Cambodia , Ethiopia and Lao People ' s Democratic Republic," no. March, 2010.
- [5] A. A. Studies and A. T. Pems, "Data Import Sheet -- CCT Aprovecho Advanced Studies in Appropriate Technology."
- [6] G. G. WOLDESELASSIE and THESIS, "Woldelessie and Thesis, "Evaluating the Efficiency of Improved Local Liquor (Areke) Distilling Stove By Measuring the Indoor Air Emission."
- [7] "Popular Summary of the Test Reports on Biogas Stoves and Lamps prepared by testing institutes in China, India and the Netherlands."
- [8] O. D. Olubiyi, "Design Construction and Performance Evaluation of a Biogas Burner," 2012.
- [9] C. for E. Studies, "Efficiency Measurement of Biogas, Kerosene and LPG Stoves," 2001.
- [10] A. F. Report, "Efficiency Measurement of Biogas Stoves Submitted to Biogas Support Partnership Nepal," no. July, pp. 1-27, 2004.
- [11] A. ABEBAW, "The Potential of Biogas Energy in Replacing the Cottage Industry Energy needs for Areke Production; the Case of Arsi Negele District, Oromia Regional State.," 2010.
- [12] M. Brander, "Greenhouse Gases, CO₂, CO₂ e, and Carbon : What Do All These Terms Mean?," 2012.
- [13] S. C. Bhattacharya, D. O. Albina, and P. A. Salam, "Emission factors of wood and charcoal-ÿred cookstoves," vol. 23, pp. 453-469, 2002.
- [14] Q. Newsletter, "Message from the Executive Director," vol. 2, no. 2, pp. 1-24, 2014.
- [15] M. Brander, "Greenhouse Gases , CO₂ , CO₂e , and Carbon : What Do All These Terms Mean?," 2012



Shewangizaw Werkagegnehu Demssie;
MSc in Sustainable Energy Engineering
and BSc in Mechanical Engineering;
Director, University Industry Linkage &
Technology Transfer; Lecturer, School of
Mechanical Engineering; Jimma Institute
of Technology (JiT); Jimma University,
Jimma, Oromia –ET, Ethiopia.



Prof. Dr. A. Venkata Ramayya;
Sustainable Energy Engineering Chair;
Professor, School of Mechanical
Engineering; Jimma Institute of
Technology (JiT); Jimma University,
Jimma, Oromia –ET, Ethiopia.



Derese Tekestebrihan Nega;
MSc in Sustainable Energy
Engineering and BSc in Physics; Chair
Person, Ethiopian Space Science
Society Jimma Branch ; Lecturer,
Department of Physics; College of
Natural Sciences; Jimma University,
Jimma, Oromia –ET, Ethiopia.