

JIMMA UNIVERSITY
SCHOOL OF GRADUATE STUDIES
JIMMA INSTITUTE OF TECHNOLOGY
SCHOOL OF CIVIL AND ENVIRONMENTAL ENGINEERING
CIVIL ENGINEERING DEPARTMENT

UNIAXIAL INTERACTION CHART OF REINFORCED CONCRETE COLUMN
CONFINED BY TRANSVERSE REINFORCEMENT

A Thesis Submitted to the School of Graduate Studies of Jimma University in Partial
Fulfillment of the Requirements for the Degree of Master of Science in Civil Engineering
(Structural Engineering)

YASIN ABDU

October 2016

Jimma, Ethiopia

JIMMA UNIVERSITY
SCHOOL OF GRADUATE STUDIES
JIMMA INSTITUTE OF TECHNOLOGY
SCHOOL OF CIVIL AND ENVIRONMENTAL ENGINEERING
CIVIL ENGINEERING DEPARTMENT

UNIAXIAL INTERACTION CHART OF REINFORCED CONCRETE COLUMN
CONFINED BY TRANSVERSE REINFORCEMENT

A Thesis Submitted to the School of Graduate Studies of Jimma University in Partial
Fulfillment of the Requirements for the Degree of Master of Science in Civil Engineering
(Structural Engineering)

By: Yasin Abdu

Advisor: Dr. Esayas G/Youhannes

Co-Advisor: Hawiso Darge (MSc.)

October 2016

Jimma, Ethiopia

DECLARATION

I, the undersigned, declare that this thesis is my original work and has not been presented for a degree in any other university and that all sources of material used for the thesis have been duly acknowledged.

Name: Yasin Abdu

Signature:

Date: October 2016

This thesis has been submitted for examination with my approval as university supervisor.

Esayas G/Youhannes (PhD)

Advisor

Signature

Date

Hawiso Darge (MSc.)

Co- Advisor

Signature

Date

ACKNOWLEDGEMENT

I would like to express my sincere and deepest gratitude to Dr. Esayas G/Youhannes who being my advisor despite his many other academic and professional works and my co-advisor Mr. Hawiso Darge for all their support.

I would like to say thanks to my brothers Mohammed, Esayas and Asaye for their support. Also I gratefully thank to all my friends who shared their help and kind support in this work: Alexander Yifter, Yibas Mamuye, Mengesha Shiferaw and Moges Getahun.

Finally I would like to give my gratitude and appreciation to all my instructors, classmates and Jimma Institute of Technology staffs who contributed in this thesis.

ABSTRACT

Transverse reinforcements have been used in reinforced concrete columns due to their advantages to fix in position of longitudinal reinforcement during construction, to shorten the buckling length of the reinforcement, to prevent shear failure and to confine the concrete. However transverse steels have confinement advantage, the design of reinforced concrete column is based on the simplified stress- strain model of unconfined concrete, and does not account for the strength gain due to confinement. The existing column design charts are also prepared based on the unconfined concrete and do not consider the strength enhancement; consequently they are in conservative side and gives uneconomical longitudinal reinforcement.

This research is conducted, analytically to determine the effect of confinement on reinforced concrete column capacity in terms of the column axial force- bending moment interaction diagram. The confined stress-strain model given in Eurocode-2 for normal strength concrete was used. The lateral pressure for circular and rectangular column section was determined for selected transverse reinforcement configurations, which are usually used for uniaxial bending. The interaction diagrams were drawn using non-dimensional axial force and bending moment capacities, which are computed at different neutral axis depths using C++ programing language.

The study shows that confinement increases the strength and ductility of the concrete, which results a considerable enlargement of axial force -bending moment capacity in the compression controlled region of the interaction diagram. Using additional cross and overlapping ties as lateral reinforcement in reinforced concrete column, further increases the column axial force- bending moment capacity. It is found that, confinement is more effective in circular sections than rectangular sections. Numerical calculation for comparison also made and it shows that reinforced concrete column designed by considering confinement requires lesser amount of longitudinal reinforcement than a column designed with the existing column design chart. Finally Uniaxial design charts for circular and rectangular reinforced concrete columns with different transverse reinforcement configurations are prepared and can be applicable for design.

Keywords: *Column, Confinement, Interaction diagram, lateral reinforcement*

Uniaxial Interaction Chart of Reinforced Concrete Column Confined
by Transverse Reinforcement

TABLE OF CONTENTS

ACKNOWLEDGEMENT	i
ABSTRACT.....	ii
TABLE OF CONTENTS	iii
LIST OF FIGURES	v
LIST OF TABLES.....	vii
LIST OF SYMBOLS	viii
CHAPTER ONE.....	1
INTRODUCTION	1
1.1. Background.....	1
1.2. Statement of the Problem.....	2
1.3. Objectives	3
1.4. Scope of the Study	3
1.5. Significance of the Study	3
1.6. Organization of the Thesis	3
CHAPTER TWO	4
LITERATURE REVIEW	4
2.1. Importance of Confinement	4
2.2. Concrete Confinement by Transverse Reinforcement	5
2.2.1. Confinement in Reinforced Concrete Column.....	5
2.2.2. Factors Affecting Confinement.....	13
2.3. Previous Investigations on Confined Concrete	14
2.4. Code Provisions for Confinement.....	22
2.5. RC Column Design Chart	23
2.5.1. Axial Force- Bending Moment Interaction	23
2.5.2. Confinement Effect on Interaction Diagram.....	25
CHAPTER THREE	27
RESEARCH METHODOLOGY.....	27
3.1. Reinforced Concrete Section	27

Uniaxial Interaction Chart of Reinforced Concrete Column Confined
by Transverse Reinforcement

3.1.1. Basic Assumptions in Ultimate Limit State	27
3.1.2. Stress- Strain Relation.....	28
3.1.3. Strain Distribution of Reinforced Concrete Section in Ultimate Limit State.....	30
3.2. Reinforced Concrete Column Interaction Chart	30
3.2.1. Stress Resultant.....	30
3.2.2. General Reinforced Concrete Column Interaction Diagram.....	31
3.3. RC Confined Column Interaction Diagram	45
3.3.1. Confinement in Reinforced Concrete Column.....	45
3.3.2. Minimum Lateral Reinforcement for RC Columns	45
3.3.3. Effective Confinement Pressure.....	47
3.3.4. RC Confined Column Design Chart	50
CHAPTER FOUR.....	55
RESULTS AND DISCUSSIONS	55
4.1. Verification of the Uniaxial Design Charts.....	55
4.2. Discussion	57
4.2.1. Rectangular columns.....	57
4.2.2. Circular columns	64
4.3. Numerical Example using the Confined Design Chart.....	67
CHAPTER FIVE	69
CONCLUSION AND RECOMMENDATION	69
5.1. Conclusion	69
5.2. Recommendation	70
REFERENCES	71
APPENDICES	74
Appendix A: C++ Program for Rectangular Confined RC Column	74
Appendix B: Unconfined Uniaxial Design Chart Given in EBCS-2, Part-2, 1995	746
Appendix C: User’s Guideline for Uniaxial Design Chart of Confined RC Column.....	777
Appendix D: Uniaxial Design Chart of Confined RC Rectangular Column	788
Appendix E: Uniaxial Design Chart of Confined RC Circular Column.....	911

LIST OF FIGURES

Figure 1.1: Confinement action in circular section	2
Figure 2.1: Configurations of transverse reinforcements in RC columns	6
Figure 2.2: Confinement pressure in circular RC section	6
Figure 2.3: Confinement Pressure in rectangular RC sections	7
Figure 2.4: Confinement pressure distribution in rectangular RC sections	7
Figure 2.5: Confinement Pressure distribution in rectangular RC sections with cross ties	7
Figure 2.6: Confinement pressure through elevation of the column	8
Figure 2.7: Effective confined concrete core in circular hoops	9
Figure 2.8: Effective confined concrete core in circular spirals	10
Figure 2.9: Effective confined concrete core in rectangular columns	11
Figure 2.10: Stress- strain model of confined and unconfined concrete by Kent and Park ...	16
Figure 2.11: Stress- strain model of confined concrete by Shiek and Uzumeri	17
Figure 2.12: Stress –strain model of confined and unconfined concrete by Mander et al.	18
Figure 2.13: Proposed stress-strain relationship by Saatcioglu and Razvi	19
Figure 2.14: Stress- strain curve for confined concrete by Bouafia et al.	21
Figure 2.15: Equivalent eccentricity	23
Figure 2.16: Strain distributions in reinforced concrete column interaction chart	24
Figure 2.17: Comparison of confined and unconfined interaction diagram of concrete column	25
Figure 2.18: Capacity gain due to confinement.....	26
Figure 3.1: Design stress-strain relation of unconfined concrete	28
Figure 3.2: Stress-strain relationship for design of confined concrete	29
Figure 3.3: Stress-strain model of reinforcing steel	29
Figure 3.4: Strain distributions in ultimate limit state.. ..	30
Figure 3.5: Stress-strain distribution for rectangular section when the neutral axis is within the section	32
Figure 3.6: Stress-strain distributions for rectangular section when the neutral axis is outside of the section	33
Figure 3.7: Rectangular column section with intermediate longitudinal bars	34
Figure 3.8: Sample uniaxial column design chart for rectangular unconfined section	36

Uniaxial Interaction Chart of Reinforced Concrete Column Confined
by Transverse Reinforcement

Figure 3.9: Segments in compression for circular columns under uniaxial bending	37
Figure 3.10: Stress-strain distribution when the neutral axis is outside of the section	38
Figure 3.11: The concrete section under parabolic compressive stress when the neutral axis is within the section	39
Figure 3.12: Stress-strain distribution for circular section when the neutral axis is outside of the section	41
Figure 3.13: Circular column section under parabolic compressive stress when the neutral axis is outside of the section	42
Figure 3.14: Sample uniaxial column design chart of unconfined circular section	44
Figure 3.15: Lateral confinement pressure	48
Figure 3.16: Sample uniaxial interaction chart of confined reinforced concrete rectangular column	54
Figure 4.1: Uniaxial design chart for unconfined reinforced concrete column	56
Figure 4.2: Interaction diagram for rectangular column with perimeter type tie ($h'/h=0.1$)..	58
Figure 4.3: Interaction diagram for rectangular column with single cross tie	59
Figure 4.4: Interaction diagram for rectangular column with double cross tie	60
Figure 4.5: Interaction diagram for rectangular column with different tie configurations...	61
Figure 4.6: Interaction diagram for rectangular column with overlapping tie	62
Figure 4.7: Interaction diagram for rectangular column with perimeter type tie ($h'/h=0.05$)	63
Figure 4.8: Interaction diagrams for RC circular spirals	64
Figure 4.9: Interaction diagrams for RC circular hoops	65
Figure 4.10: Interaction diagrams for RC circular columns	66
Figure 4.11: Interaction diagrams of RC circular spiral column with $\gamma= 5.775\%$	68

LIST OF TABLES

Table 3.1: Minimum lateral reinforcement volumetric ratio required	47
Table 3.2: Effective confinement coefficient	49
Table 3.3: Strength enhancement factor for circular columns	51
Table 3.4: Strength enhancement factor for rectangular columns with perimeter and single cross tie type.....	52
Table 3.4: Strength enhancement factor for rectangular columns with double cross tie and overlapping tie types	53
Table 3.4: Strength enhancement factor for rectangular columns of perimeter type tie with h'/h of 0.05 and 0.15	53
Table 4.1: Mechanical reinforcement ratio required for verification.....	55

Uniaxial Interaction Chart of Reinforced Concrete Column Confined
by Transverse Reinforcement

LIST OF SYMBOLS

A_{st} -	Area of longitudinal reinforcement bar
A_g or A_c -	Area of concrete
A_p -	Area of transverse reinforcement
b -	Width of section
B_c -	Width of core section
d -	Effective concrete depth
D_c -	Depth of core section
E_c -	Modulus of elasticity of concrete
E_s -	Modulus of elasticity of steel
F_{ck} -	Characteristic compressive strength of concrete
$F_{ck,c}$ -	Characteristic compressive strength of confined concrete
FRP-	Fibber reinforced plastic
f_{cd} -	Design compressive strength of concrete
$f_{cd,c}$ -	Design compressive strength of confined concrete
f_1 -	Confinement pressure
f_{1e} -	Effective confinement pressure
f_s -	Reinforcing steel stress
f_y -	Reinforcing steel yield stress
f_{yd} -	Reinforcing steel design stress
f_{yk} -	Characteristic strength of reinforcing steel
F_c -	Concrete compressive force
F_{cr} -	Concrete compressive force due to rectangular stress portion
F_{cp} -	Concrete compressive force due to parabolic stress portion
F_s -	Force in reinforcing steel

Uniaxial Interaction Chart of Reinforced Concrete Column Confined by Transverse Reinforcement

h -	Depth of section
h' -	Effective concrete cover
HCR -	High compressive strength concrete
K_c -	Strength enhancement factor of confined concrete
K_e -	Confinement effectiveness coefficient
m_i -	Stress ratio of longitudinal reinforcement steel
M -	Moment
M_c -	Moment of concrete compressive stress about centroid of the section
M_{cp} -	Moment of concrete parabolic compressive stress from centroid of the section
M_{cr} -	Moment of concrete rectangular compressive stress from centroid of the section
M_u -	Bending moment capacity of column
NCR -	Normal Compressive strength concrete
n -	Number of longitudinal reinforcement bars in the section
P -	Applied axial force
P_u -	Axial load capacity of the column
S -	Centre to centre spacing of lateral reinforcement
S' -	Clear distance between lateral reinforcements
X -	Neutral axis depth
α_c -	Concrete compressive force coefficient
β_c -	Coefficient of the distance of compressive force from extreme compression fiber
ϵ_{cm} -	Maximum concrete compressive strain
ϵ_{c2} -	Concrete strain at maximum stress
$\epsilon_{c2,c}$ -	Confined Concrete strain at maximum stress
ϵ_{cu2} -	Ultimate concrete strain

Uniaxial Interaction Chart of Reinforced Concrete Column Confined
by Transverse Reinforcement

$\varepsilon_{cu2,c}$ -	Ultimate confined concrete strain
ε_s -	Reinforcing steel strain
ε_{yd} -	Reinforcing steel design strain
σ_2 and σ_3 -	Lateral pressures
σ_c -	Concrete compressive stress
θ_1 -	Inclination of the parabolic compressive stress from the centroid of the section
θ_2 -	Inclination of the neutral axis from the centroid of the section
ω -	Mechanical longitudinal reinforcement ratio
γ -	Mechanical ratio of lateral reinforcement
ρ_s -	Volumetric reinforcement ratio of lateral reinforcement
ν -	Non-dimensional column axial force capacity
μ -	Non-dimensional column bending moment capacity

CHAPTER ONE

INTRODUCTION

1.1. Background

Reinforced concrete columns are the main load bearing elements of a structure. They support the beams, floor slabs and roofs and transfer the loads to the foundations. The loads are in the form of axial force, shear force and bending moments. These internal forces are resisted by providing adequate column cross sections, sufficient longitudinal and transverse reinforcement steel bars. The longitudinal reinforcements are provided to resist the applied axial force and bending moments; whereas the main functions of transverse reinforcement for a column are to prevent shear failure, to avoid buckling of longitudinal bars and to fix in position of the longitudinal bars during construction. In addition to this the presence of lateral reinforcement for reinforced concrete columns in the form of spirals or close ties will develop a confinement effect which will provide sufficient ductility and enhance load carrying capacity.

Nowadays in Ethiopia, different high rise irregular structures are constructed and which become more susceptible for dynamic loads, to prevent the structures from failure due to this lateral loads the building codes recommend to construct a more ductile structural member. To ensure the ductility of reinforced concrete columns and beams, lateral reinforcements are required in the form of spirals or close ties which have a confinement effect on the concrete.

When concrete is subjected to compressive load, it undergoes volumetric changes with a lateral increase in dimensions due to Poisson's effect. If transverse reinforcement is provided in the form of the spirals, hoops or ties, it resists this tendency of lateral expansion of concrete by developing tensile forces and consequently exerting a compressive reaction on the concrete core. In this state of multi-axial compression, both the deformation capacity and strength of the concrete are enhanced. Such concrete is said to be confined. In confined concrete the lateral pressure that induces in the concrete, a tri-axial state of stresses and consequently an increment of compressive strength and ultimate axial strain. The strength and ductility of concrete under tri-axial compression exceed those under uniaxial compression [25].

For design of reinforced concrete columns, a simplified interaction chart is provided in which the column cross section and the required longitudinal reinforcement can be determined. The interaction diagram is a surface which defines the maximum capacity of compression members that are subject to axial force and bending moments.

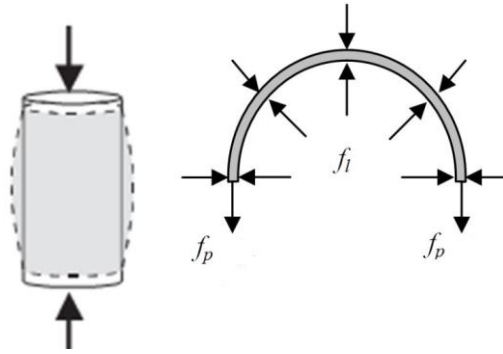

Figure 1.1 Confinement action in circular section

The design of the reinforced concrete column is based on the simplified stress block of unconfined concrete. Thus the existing interaction diagrams developed for the column capacity are also based on the unconfined concrete model that does not account for the strength gain from the presence of confinement, but a confined concrete stress-strain model which considers the effect of lateral reinforcement on the axial load capacity can be used for design of reinforced concrete columns. This gives a more accurate prediction on the load resistance of concrete in a column thus, resulting more economical column cross section and longitudinal reinforcement. In this study the column interaction diagrams will be developed considering confined concrete.

1.2. Statement of the Problem

Transverse reinforcements in the form of spirals and close ties provide confinement effect on reinforced concrete columns which enhances the load carrying capacity of the columns. Several researchers have performed experimental and analytical investigations on confined concrete and propose a stress-strain model and they agree that confinement can enhance the strength and ductility of the concrete. Even though transverse reinforcements have such advantages in addition to prevent local buckling of longitudinal bars, provide resistance against shear and torsion and hold in position of longitudinal bars; EBCS -2 1995 and the existing column design charts do not consider the enhancement of strength due to lateral reinforcement for design of concrete structures which leads a conservative design and gives uneconomical longitudinal reinforcement.

Therefore, this research focuses about the transverse reinforcement effect on the axial force-bending moment interaction and to prepare a uniaxial reinforced concrete column design chart considering the strength gained by confinement.

1.3. Objectives

General Objective

The main objective of this research is to prepare uniaxial design charts of reinforced concrete columns considering the effect of confinement due to transverse reinforcements.

Specific Objectives

- To determine confinement effect on structural properties of concrete.
- To determine the effect of confinement on axial force -bending moment interaction of reinforced concrete column.
- To prepare confined reinforced concrete column uniaxial design charts.

1.4. Scope of the Study

This study shall cover the effect of confinement due to transverse reinforcement on the axial force- bending moment capacity of circular and rectangular reinforced concrete columns and preparing a uniaxial interaction chart for the design of normal strength concrete columns considering confinement effect.

1.5. Significance of the Study

The research is conducted to verify the positive impact of lateral reinforcements on load carrying capacity of reinforced concrete columns, which enables to predict the actual axial force- bending moment resistance of reinforced concrete columns and to determine the size of the column section and the amount of longitudinal reinforcement required reasonably. Project clients, structural engineers, architects and contractors will benefit from this research.

1.6. Organization of the Thesis

The research is organized in to five chapters. The first chapter is stated about the general background, objectives and scope of the study. The second chapter describes previous works done about the effect of transverse reinforcement confinement on the capacity of reinforced concrete columns. The third chapter is the main body of the research, which consists of the methodology used, and the procedures followed in conducting the research. The fourth chapter consists of discussion and verification of the design charts and finally the fifth chapter provides conclusion and recommendations of the research.

CHAPTER TWO

LITERATURE REVIEW

Confinement of concrete by transverse reinforcement has become an important objective in the design of reinforced concrete structure, because it can increase the load carrying capacity of concrete during large inelastic strains. Where concrete is subjected to a large compressive load, confinement has been shown to increase both the compressive strain and stress. In addition, the bond between longitudinal reinforcement and concrete is enhanced by confinement. Moreover, the longitudinal reinforcement is prevented from premature buckling due the provision of closely spaced transverse reinforcement [24].

There are two different methods for confining concrete. In the first method of confinement, which is famous as active confinement, from the beginning of confinement, a primary lateral pressure is applied on column. In the second method which is known as passive confinement, lateral expansion is limited by confining concrete with some elements such as steel jackets, FRP sheets, close ties or spirals; therefore tension axial forces are created in these confining elements. The increase of axial load in the column in this case increases the degree of confinement. The transverse steel limit lateral expansion of concrete leading to tensile stress in lateral steel [29].

2.1. Importance of Confinement

Confinement offers two main advantages to the behaviour of concrete structural elements [37].

A. Ductility Improvement

Ductility can be defined as the ability of sections, members or structures to undergo deformations without a significant loss of strength. Unconfined concrete, which is compressed in only one direction without lateral restraint behaves like a brittle material with minimal ductility. When concrete is confined by compressive stresses in all directions, the ductility of concrete can improve significantly.

B. Enhancement of Compressive Strength

Confinement increases the strength of concrete; researches have shown compressive strength enhancement up to 70%. On stress-strain curves, improved strength is represented by an increase in the peak compressive stress values.

2.2. Concrete Confinement by Transverse Reinforcement

The introduction of adequate transverse reinforcing steel to confine concrete under compressive loading affects the expansion behaviour of concrete. When the concrete is axially loaded, the transverse reinforcement is hardly stressed until the load at which concrete develops appreciable lateral strains. At these strains, the concrete contained within the transverse reinforcement begins to expand outwards under continued axial load and bears against the transverse steel. The transverse steel tends to resist the lateral expansion of the concrete, creating a reactive confining pressure against the concrete core contained within the boundary of the transverse reinforcement [38].

The spiral reinforcement or the rectilinear ties in reinforced concrete play an important role in enhancing the strength and ductility. Under axial loads, concrete pressure in the lateral direction of the section acts on the lateral ties and the resistance of the ties may restrain the core of concrete to a degree. The magnitude of the increase is established by various confining parameters such as the compressive strength of the concrete, the volumetric ratio, the diameter the configuration and the strength of the ties and the ratio and the diameter of the longitudinal bars and the section geometry, etc. [6].

2.2.1. Confinement in Reinforced Concrete Column

Lateral ties not only hold the longitudinal reinforcement of columns in place, but also help reduce their premature failure by buckling. Closely spaced lateral ties, confine the core concrete and help concrete behave like a fluid under pressure. Lateral ties, in fact contribute to carrying capacity of the column, but has been ignored, as they are present at discrete locations [25].

Confinement in reinforced concrete columns is often provided by a combination of longitudinal reinforcing bars contained within a boundary of transverse reinforcement. The transverse reinforcement may be in the form of continuous spirals or circular hoops placed at close intervals, or by rectilinear overlapping hoops and ties. The concrete area enclosed by the perimeter of the center lines of the outer ring of the spirals or hoops is often referred to as the concrete core [17]. Some typical arrangements of transverse reinforcement in columns are shown in Figure 2.1.

Uniaxial Interaction Chart of Reinforced Concrete Column Confined
by Transverse Reinforcement

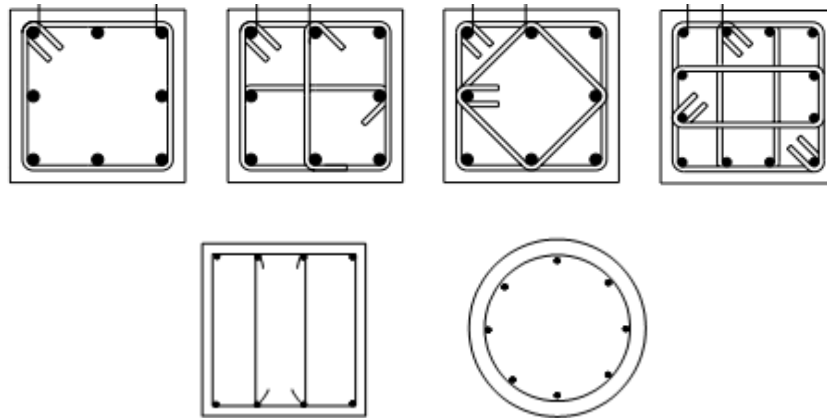

Figure 2.1 Configurations of transverse reinforcements in RC columns [Source: Yoon et al.]

When circular spirals or hoops are used for transverse reinforcement in columns, the lateral expansion of concrete is commonly assumed to extend a uniform pressure against the reinforcement. The reinforcement itself would then exert an equal and opposite reaction against the concrete core. Hence the circumference of the concrete core bounded by the lateral steel is effectively confined by a continuous, uniform confining pressure. Figure 2.2 illustrates the uniform confining pressure on the concrete core assumed to be provided by circular spirals or hoops.

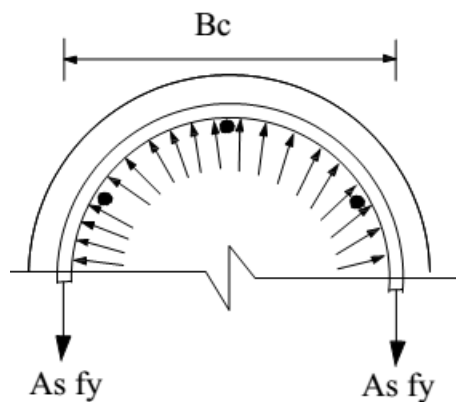

Figure 2.2 Confinement pressure in circular RC section

When concrete is confined by rectangular ties, the reinforcement does not provide a uniform confining pressure on the concrete core. Under axial loading, the concrete expands laterally and bears against the reinforcement tie, and the tie is unable to provide a uniform reaction against the concrete. The reinforcement ties exert a confining reaction at the corners of the ties, but the straight lengths between the corners tend to bend outward on all four sides. Because of the bending action of the ties, some areas of the concrete remain unconfined and the concrete is only effectively confined in the central region of the core and at the corners. The maximum transverse pressure from the confining reinforcement can only be exerted effectively

Uniaxial Interaction Chart of Reinforced Concrete Column Confined by Transverse Reinforcement

on that part of the concrete core where the confining stress has fully developed due to arching action [18].

Passive confinement pressure exerted by a square hoop is dependent on the restraining force developed in the hoop steel. The hoop steel can develop high restraining forces at the corners, where it is supported laterally by transverse legs, and low restraining action between the laterally supported corners. As the concrete expands laterally under axial compression, there will be higher reactive pressures building up at the nodal points than at locations away from the nodes as shown in Figure 2.4. If cross ties or inside hoops are used to support the middle bars, additional points of high lateral restraint are generated [33]. It is clear that the shape of the pressure distribution is a function of the reinforcement arrangement as shown in Figure 2.5.

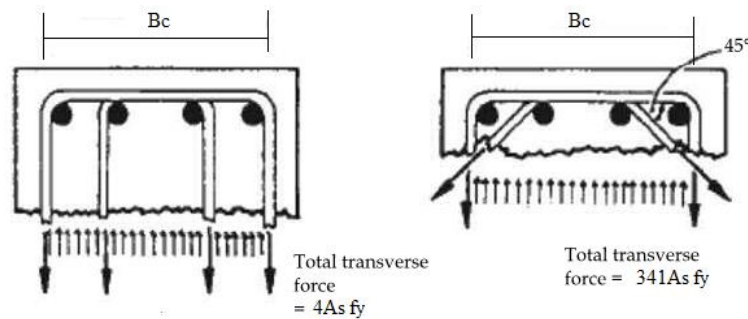

Figure 2.3 Confinement Pressure in rectangular RC sections [Source: Watson et al.]

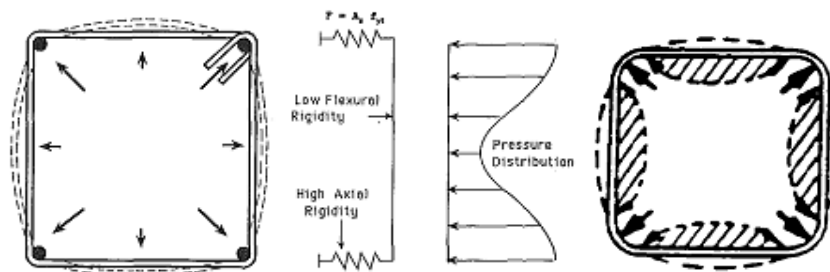

Figure 2.4 Confinement pressure distribution in rectangular RC sections
[Source: Saatcioglu and Razvi]

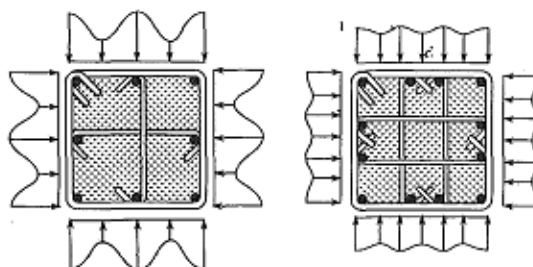

Figure 2.5 Confinement Pressure distribution in rectangular RC sections with cross ties
[Source: Saatcioglu and Razvi]

Uniaxial Interaction Chart of Reinforced Concrete Column Confined by Transverse Reinforcement

Concrete confinement is a three-dimensional phenomenon that cannot be reduced to a sectional level. Therefore, it is essential to consider the variation of lateral pressure along the column length.

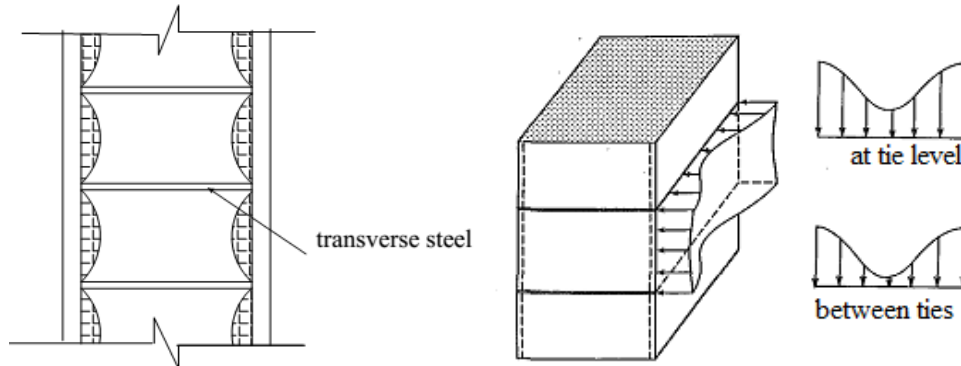

Figure 2.6 Confinement pressure through elevation of the column

When transverse reinforcement is spaced apart at different levels over a column's height, the effectiveness of confinement of the concrete core reduces at locations away from the lateral reinforcement and is at a minimum midway between any two levels of reinforcement. Adequate spacing of transverse reinforcement results in a larger area of effectively confined concrete and hence a more efficient confinement. Midway between the levels of the transverse reinforcement, the area of ineffectively confined concrete will be the largest and the area of effectively confined concrete will be the smallest. This poor distribution of confining pressure is the main reason that circular spirals confine concrete more effectively than rectangular hoops of the same steel area and spacing.

For circular column considering the half body confined by spiral or circular hoop, as shown in figure 2.2, the lateral pressure is:

$$2f_{yl} A_{sp} = f_l S B_c$$

$$f_l = \frac{2f_{yl} A_{sp}}{S B_c} \quad (2.1)$$

where f_l = lateral pressure from the transverse reinforcement,

A_{sp} = area of lateral reinforcement,

f_{yl} = yield strength of the lateral reinforcement,

S = center to center spacing of lateral reinforcement along column height and

B_c = diameter of the concrete core.

Uniaxial Interaction Chart of Reinforced Concrete Column Confined by Transverse Reinforcement

To consider the non-uniformity of confining pressure longitudinally and transversely of the column section, an equivalent lateral pressure, f_{le} is used in the stress- strain relation of the concrete.

$$f_{le} = K_e f_l \quad (2.2)$$

K_e = The coefficient of confinement effectiveness

Mander et al.[18] propose a confinement effectiveness coefficient based on Shiekh and Uzumeri work [37].

$$K_e = \frac{A_e}{A_c} \quad (2.3)$$

Where A_e = area of effectively confined concrete core and A_c = area of core of section enclosed by the centerline of the perimeter spiral or hoop

For circular sections with hoops the arching action shown in figure is assumed to occur in the form of second degree parabola with an initial slope of 45° , the area of an effectively confined concrete core at midway between the levels of transverse reinforcement is:

$$A_e = \frac{\pi}{4} \left(D_c - \frac{S'}{2} \right)^2 = \frac{\pi}{4} D_c^2 \left(1 - \frac{S'}{2D_c} \right)^2$$

$$A_c = \frac{\pi D_c^2}{4} \quad (2.4)$$

Where, S' is clear vertical spacing between circular hoops

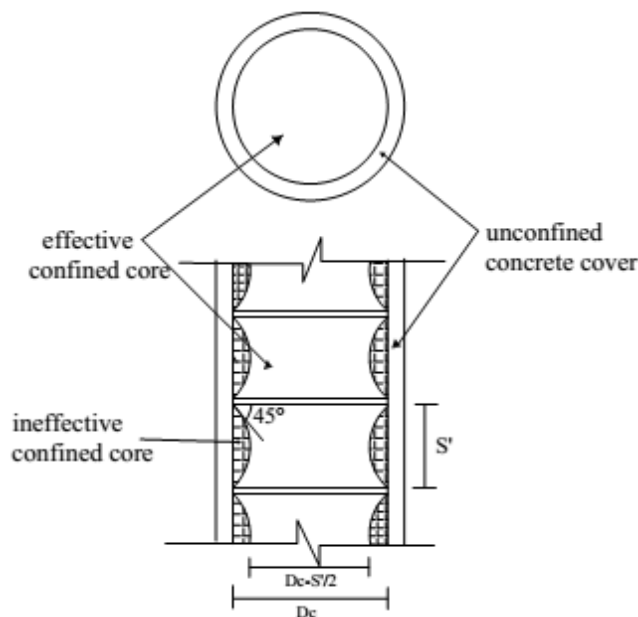

Figure 2.7 Effective confined concrete core in circular hoops

Uniaxial Interaction Chart of Reinforced Concrete Column Confined
by Transverse Reinforcement

From equation 2.3 for geometric effectiveness coefficient of confinement for circular hoops:

$$K_e = \left(1 - \frac{S'}{2D_s}\right)^2 \quad (2.5)$$

Similarly for circular spiral:

$$A_e = \frac{\pi}{4} \left(D_c - \frac{S'}{4}\right)^2 = \frac{\pi}{4} D_c^2 \left(1 - \frac{S'}{4D_c}\right)^2 = \frac{\pi}{4} D_c^2 \left(1 - \frac{S'}{2D_c} + \left(\frac{S'}{4D_c}\right)^2\right)$$

Neglecting the last term, it becomes;

$$A_e = \frac{\pi}{4} D_c^2 \left(1 - \frac{S'}{2D_c}\right) \quad (2.6)$$

$$K_e = \left(1 - \frac{S'}{2D_c}\right) \quad (2.7)$$

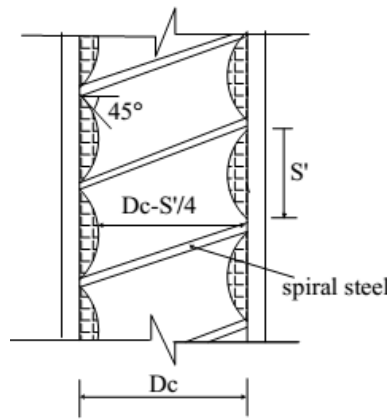

Figure 2.8 Effective confined concrete core in circular spirals

For rectangular section the arching action is again assumed to act in the form of second degree parabolas with initial tangent slope of 45° . Arching occurs both in vertically between layers of transverse hoop bars and longitudinally between longitudinal bars as shown in Figure 2.9. The effectively confined area of concrete at hoop level is found by subtracting the areas of parabolas containing the ineffectively confined concrete.

The total plan area ineffectively confined core concrete at the level of the hoops where there are n number of longitudinal bars is:

$$A_i = \sum_1^n \frac{w_i^2}{6} \quad (2.8)$$

w_i = clear distance between adjacent longitudinal bars

Incorporating the influence of the ineffective areas in longitudinal, the area of effectively confined core concrete at midway between the level of transverse hoop reinforcement is;

Uniaxial Interaction Chart of Reinforced Concrete Column Confined
by Transverse Reinforcement

$$A_e = (B_c D_c - \sum_1^n \frac{w_i^2}{6}) (1 - \frac{S'}{2B_c}) (1 - \frac{S'}{2D_c}) \quad (2.9)$$

Where B_c and D_c are the core dimensions to center line of perimeter hoop in x and y directions.

Then, the area of confinement effectiveness coefficient for rectangular hoops become;

$$K_e = (1 - \sum_1^n \frac{w_i^2}{6B_c D_c}) (1 - \frac{S'}{2B_c}) (1 - \frac{S'}{2D_c}) \quad (2.10)$$

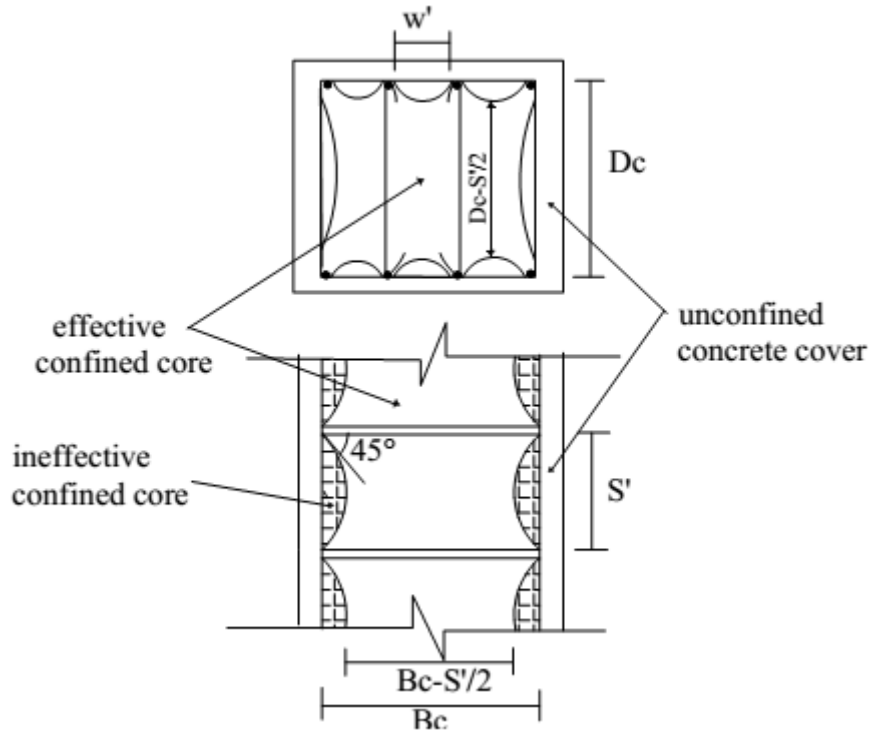

Figure 2.9 Effective confined concrete core in rectangular columns

Paultre and Legeron [28] expressed the confinement effectiveness coefficient as a product of two terms: 1) a horizontal arching coefficient K_h and 2) a vertical arching coefficient K_v

$$K_e = K_h K_v \quad (2.11)$$

For rectangular columns

$$K_v = (1 - \frac{S'}{2B_c}) (1 - \frac{S'}{2D_c}) \quad (2.12a)$$

$$K_h = (1 - \sum_1^n \frac{w_i^2}{6B_c D_c}) \quad (2.12b)$$

For circular columns, $K_h = 1 \quad (2.13a)$

For circular hoop, $K_v = (1 - \frac{S'}{2B_c})^2 \quad (2.13b)$

For circular spiral, $K_v = (1 - \frac{S'}{2B_c}) \quad (2.13c)$

Uniaxial Interaction Chart of Reinforced Concrete Column Confined by Transverse Reinforcement

It is possible to simplify equation 2.12b for square columns regularly spaced longitudinal reinforcement

$$w_i = w = \frac{4}{n} D_s - D_b \quad (2.14)$$

Where D_s is the distance between compression and tension reinforcement, n and D_b are the number and diameter of longitudinal bars respectively. Using the fact that D_b/D_s is generally small and neglecting higher order terms, equation 2.12b can be approximated by;

$$K_h = 1 - \frac{8D_s^2}{3nBc^2} \left(1 - \frac{nD_b}{2D_s}\right) \quad (2.15)$$

To express K_h independent of S , D_b and Bc it can be simplified conservatively as;

$$K_h = 1 - \frac{2}{n} \quad (2.16)$$

The dependence of K_v on S can be removed by using conservative values of K_v in which the minimum requirements of the code satisfied. Minimum values of K_v should be used as that would ensure conservative confinement reinforcement ratios. To arrive at a conservative expression for K_v , the researchers calculated a large number of different columns using minimum transverse reinforcement and suggested;

For rectangular and square columns;

$$K_v = 1.0 \left(\frac{A_c}{A_g}\right) \quad (2.17)$$

Where A_c = concrete core area and A_g = gross column area

For circular columns with spiral reinforcement

$$K_v = 0.9 + 0.05 \frac{A_c}{A_g} \quad (2.18)$$

For circular columns with hoop

$$K_v = \left(0.9 + 0.05 \frac{A_c}{A_g}\right)^2 \quad (2.19)$$

The comparison of the stress-strain curves clearly indicates that columns with circular cross-section perform better than those with square ones. The columns with circular cross-sections had greater peak stress and strain values than the square ones. Therefore, if the same percentages of strength and ductility enhancements are desired, square or rectilinear confined columns are required to be confined more vigorously than circular columns [5].

2.2.2. Factors Affecting Confinement

Reinforced concrete columns contain three main components; longitudinal reinforcing steel, transverse reinforcing steel, and concrete. The effectiveness of confinement in columns is affected by the properties and design of this three components. Some of the important factors which affect the confinement in reinforced concrete columns have been investigated by several researchers and are described below.

a. Amount of Transverse Steel

The amount of spiral steel in columns is usually expressed by the volumetric ratio of transverse steel to the concrete core and is one of the most important factors affecting concrete confinement. Large amounts of transverse steel increase the lateral confinement pressure that can be exerted on the concrete core and often improves the strength and ductility of the concrete [35].

b. Spacing of transverse reinforcement

Closer spacing improves the distribution of confinement pressure over the column height by increasing the area of effectively confined concrete and also helps to prevent the premature buckling of longitudinal steel bars. If transverse steels are spaced too far apart, the confining forces on the concrete sections between the spiral levels begin to decrease substantially [40].

c. Size of transverse steel

Larger diameter reinforcing bars with greater flexural stiffness provide more resistance to the expansion of the concrete core and better support of longitudinal steel against buckling.

d. Strength of transverse steel

Confinement pressure is generated from the tensile forces that develop in the transverse reinforcement. It would be expected that transverse steels with higher yield strength would be capable of exerting larger confining pressures on the concrete core. However the development of tensile stresses in transverse steel is dependent on the lateral expansion properties of concrete [33].

e. Configuration of Transverse steel

The configuration of transverse reinforcement reflects the effectively confined concrete area. A properly configured column would result in effectively confined concrete core of higher confinement efficiency [37].

f. Longitudinal Steel

Longitudinal steel provides additional confinement reactions on the concrete core, particularly between the spacing of transverse steel. Distributing the longitudinal reinforcement throughout the perimeter of a rectangular section increases the effective core area. A minimum number of longitudinal bars of adequate bar size are required to provide stability for the reinforcing cage and the entire column. Better concrete confinement is obtained when a large number of smaller diameter longitudinal bars are used to make up the required area of longitudinal reinforcement [23].

g. Concrete Strength

The lateral expansion of core concrete plays an important role in the effective confinement of concrete. Due to higher modulus of elasticity, high strength concrete in columns will experience less micro cracking and consequently less core lateral expansion than in normal strength concrete columns. The lateral expansion or concrete pressure increases with the increase in axial loads. At this time, the ties resist the high expansion pressure, and the proper confinement by lateral ties, leads to the enhancement of axial load-carrying capacity. But high strength concrete columns show less lateral expansion than the normal-strength concrete columns. After the maximum axial load, the high-strength concrete columns show deterioration in ductility. Confinement effects on high-strength concrete are not effective as those on the normal-strength concrete [7].

2.3. Previous Investigations on Confined Concrete

The earliest researches on laterally reinforced concrete columns performed axial compression tests and realized that concrete columns reinforced exclusively with longitudinal steel bars had larger compressive strengths than plain concrete columns of identical size. However, the concrete columns with longitudinal reinforcement were observed to develop longitudinal cracks and excessive lateral deformations under large compressive loads. The introduction of lateral reinforcements in the columns is an attempt to slow down the lateral expansion of the concrete and found that the lateral steels when placed at an appropriate spacing, led to an increase in the maximum strength and axial deformations achieved by the specimens.

The researchers showed that the strength and the corresponding longitudinal strain in concrete confined by hydrostatic pressure can be determined by the following relationship.

Uniaxial Interaction Chart of Reinforced Concrete Column Confined by Transverse Reinforcement

$$f_{cc} = f_c + K_1 f_l$$

$$\varepsilon_{cc} = \varepsilon_c \left(1 + k_2 \frac{f_l}{f_c} \right)$$

Where f_{cc} and ε_{cc} are the maximum concrete stress and the corresponding strain respectively under the lateral pressure, f_l ;

f_c and ε_c are the unconfined concrete stress and the corresponding strain respectively; and K_1 and K_2 are coefficients which are a function of the concrete property and the lateral pressure.

There have been many attempts to describe the stress-strain relation of confined concrete. The main objective of most researchers was to examine the effects of various design variables on the specimen performance and to propose analytical models for the stress- strain curves of confined concrete. Some of them are reviewed below.

1. Richart, Brandtzaeg and Brown ,1929 [31]

Richart et al. from the University of Illinois carried out a series of compression tests on circular concrete specimens laterally confined with hydraulic pressure and later by spiral reinforcement steel. This group measured the series increment in spiral reinforcement and conclude that the increase in compressive strength of specimens was proportional the passive confining pressure provided by the spiral reinforcement.

Test results from the specimens was analysed to determine a relationship between the maximum column strength and the average lateral stress f_l on the concrete core.

$$f_{cc} = f_c + 4.1 f_l$$

where f_{cc} is the maximum column strength and f_c is the compressive strength of plain concrete.

The researchers rationalized that the spiral reinforcing steel in the column essentially behaved like a thin walled steel cylinder to confine the concrete core and the lateral stress on the concrete is;

$$f_l = \frac{\rho_s f_s}{2}$$

where ρ_s is the volumetric ratio of lateral reinforcement

Richart latter in 1946 conducted series of tests by varying the amount of spiral reinforcement and he observed that when the amount of transverse reinforcement is increased the columns developed a second maximum load which exceeded the first load at spalling.

2. Desayi, Iyengar and Reddy, 1970 [9]

Desayi et al. conducted axial compression tests of circular and square columns by varying the concrete strength, size, spacing and strength of transverse reinforcement. The researchers concluded that the use of lateral reinforcement increased both the strength and deformation capacity of the column. Peak strength and the corresponding axial strain were found in increase with increasing of yield strength and volumetric ratio of lateral steel.

Relative gains in the confined specimen peak strength and corresponding strain were found to decrease as the compressive strength of the concrete in the specimen increased. In addition, circular spiral steel was found to provide more effective confinement than an equivalent amount of square spiral steel.

3. Kent and Park ,1982 [16]

Kent and Park (1971) developed a stress-strain relation of confined concrete from the stress-strain relation of unconfined concrete. The proposed model doesn't consider strength enhancement of confinement. But Park et al. (1982) modified the original stress –strain model relation proposed by making an allowance for the enhancement in the concrete strength and the peak strain due to confinement.

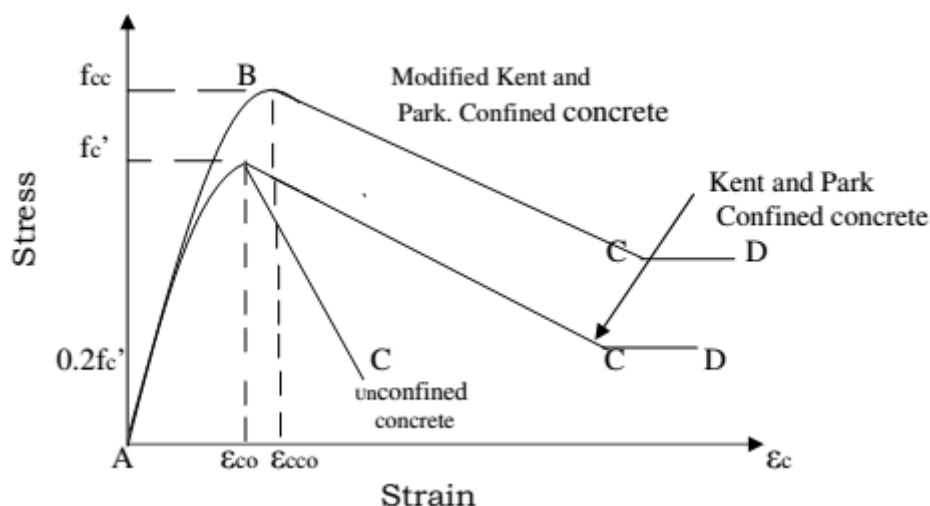

Figure 2.10 Stress- strain model of confined and unconfined concrete by Kent and Park

4. Ahmed and Shah, 1982 [1]

Ahmad and Shah carried out tests on several small-scale specimens with the purpose of obtaining complete stress-strain curves of concrete cylinders confined by spiral reinforcement. Several cylinder specimens were tested to evaluate the effects of concrete strength, and spiral reinforcement spacing and yield strength on stress-strain curves.

The slope of the descending region of the stress-strain curve deteriorated more rapidly with larger concrete cylinder strengths. The researchers concluded that the effectiveness of spirals at the peak confined concrete stress decreased with larger concrete cylinder strengths.

Unlike other researchers Ahmed and Shah reported that increasing the yield strength of the spiral steel did not influence the compressive strength of the confined concrete, but was found to improve the ductility of the descending portion of the stress-strain curve. Specimens made with the same concrete were observed to have similar steel stresses at peak loads regardless of the yield strength of the spirals.

It was concluded that the confining pressure exerted by spirals depends on the potential lateral expansion of the corresponding plain concrete. This lateral strain increased non-linearly with increasing axial stress, and for a given value of axial stress, it was less for high strength concrete.

5. Sheikh and Uzumeri, 1982 [37]

Sheik and Uzumeri made analytical and experimental studies on the mechanism of confinement in tied columns. They introduced the concept of the effectively confined concrete area and presented the stress-strain relations of confined concrete.

The increase in strength of confined concrete is calculated on the basis of the “effectively confined” concrete area. This area is less than the nominal core area bounded by the center line of the perimeter tie and is determined by tie configuration and tie spacing.

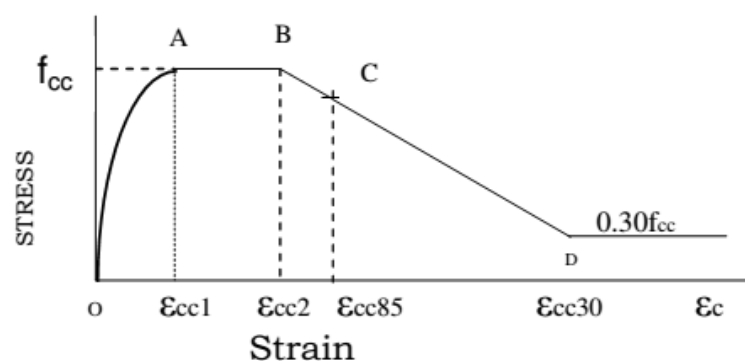

Figure 2.11 Stress- strain model of confined concrete by Shiek and Uzumeri

6. Faftis and Shah, 1985 [13]

Based on the experimental results of small-diameter concrete cylinders, Fafitis and Shah proposed a set of equations to represent stress-strain curves for spirally confined and unconfined concrete. They conclude that the maximum capacity of confined concrete occurs when the cover starts to spall off. It was suggested by the authors that the model can also be used for columns with rectilinear lateral reinforcement.

7. Mander, Priestley and Park, 1988 [18]

Mander et al. have tested square, rectangular and circular full scale columns considering various configurations and proposed a unified stress-strain model for confined concrete that is applicable to both circular and rectilinear transverse reinforcement.

The researchers reported that the most significant parameter affecting the shape of the stress-strain curve of confined concrete was the volumetric ratio ρ_s of lateral reinforcement. As the volumetric ratio of confining reinforcement increased the specimen's peak stress increased, the strain at peak stress increased, the slope of the falling branch decreased, and the longitudinal strain at which spiral fracture occurred increased. The researchers found that decreasing the spiral spacing in specimens with an equal volumetric ratio of spiral reinforcement resulted in only minimal improvements in the slope of the falling branch of the confined concrete stress-strain curve.

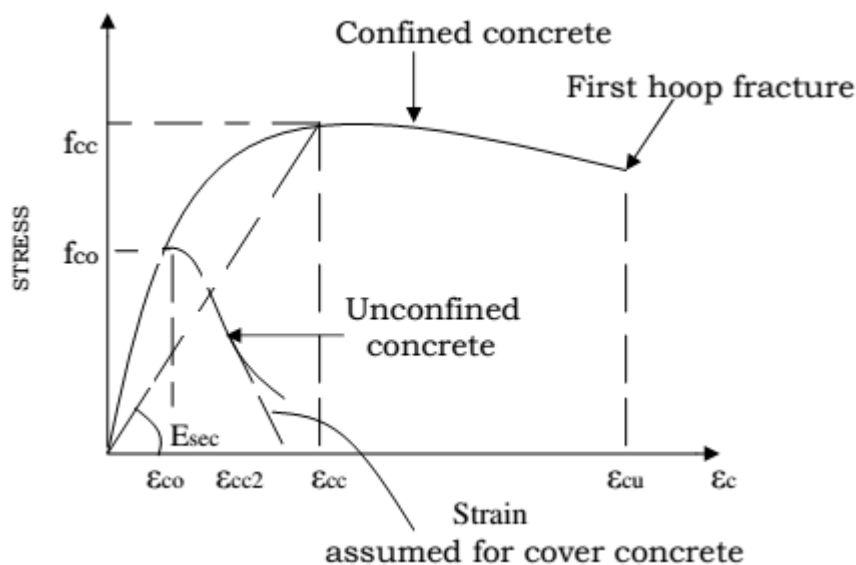

Figure 2.12 Stress –strain model of confined and unconfined concrete by Mander et al.

8. Murat Saatcioglu and Salim R. Razvi, 1992 [33]

An analytical model is proposed to construct a stress-strain relationship for confined concrete. The model consists of a parabolic ascending branch, followed by a linear descending segment. It is based on calculation of lateral confinement pressure generated by circular and rectilinear reinforcement, and the resulting improvements in strength and ductility of confined concrete. A large volume of test data, including poorly confined and well-confined concrete was evaluated to establish the parameters of the analytical model. The equivalent uniform pressure is obtained from average lateral pressure computed from sectional and material properties. Confinement by a combination of different types of lateral reinforcement is evaluated through superposition of individual confinement effects.

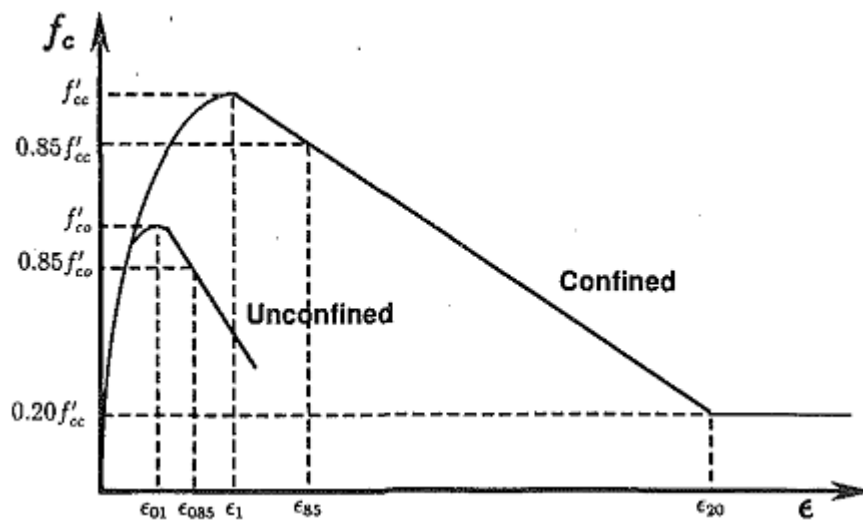

Figure 2.13 Proposed stress-strain relationship by Saatcioglu and Razvi

Saatcioglu and Razvi also reported on confinement effectiveness in different configurations of transverse reinforcement and their difference based on analytical and experimental results.

9. Shiekh and Tokluku, 1993 [36]

Shiekh and Tokluku conducted axial load tests on circular columns to determine the effects of amount, type and spacing of lateral steel, and specimen size on the behaviour of the columns.

They prepared stress-strain curves for confined columns and reported that increasing the volumetric ratio of lateral steel resulted an increment in the strength and ductility of confined concrete and column size did not have a significant effect on confined column behaviour when all longitudinal and lateral reinforcing parameters were scaled properly and circular hoops performed as effectively as an equivalent amount of spiral reinforcement.

10. Beni Assa, Minehiro Nishiyama and Fumio Watanabe, 2001 [3,4]

An analytical stress-strain model for concrete confined by spiral steel was developed. The deformation behaviour of concrete under axial and lateral compression provided at discrete locations was studied experimentally, and the response characteristics of spiral to lateral expansion of concrete was determined theoretically. Assa et al. presented a model for predicting the stress-strain curve of confined concrete based on concrete–transverse steel interaction (or confinement mechanism).

The lateral strain increases with an increase in spacing of spirals or hoops. It was also observed that the increase in lateral strain is more significant in the normal strength concrete specimens than in the high strength concrete specimens. The characteristic values were found to be linearly related to the ratio of lateral stress at peak axial stress to the unconfined compressive strength.

The researchers later extended the work for concrete confined by rectangular ties and reached similar conclusions as the concrete confined by spirals.

11. Chung H S, Yang K H, Lee Y H and Eun H C, 2002 [7]

Chung et al. performed experiments about strength enhancement of rectangular columns due to confinement by transverse reinforcement and proposed a formula for the peak strength of a confined concrete considering different parameters, include the compressive strength of concrete, the volumetric ratio, yield strength and confinement type of rectangular ties and the distribution of longitudinal reinforcement bars.

The magnitude of the strength enhancement depends on various parameters mentioned previously. Using these parameters the strength enhancement factor can be written as:

$$K_s = 1 + \Delta K_s (\rho_s, f_y, f_c', \lambda)$$

where $\rho_s (= 4A_{sp}/B_c S)$ is the volumetric ratio of lateral ties, A_{sp} is the cross-sectional area of the lateral ties, f_y is the tie stress at the maximum load, and λ is the effectively confined ratio.

Chung et al. concluded that high-strength concrete specimen needs stronger confinement to maintain the proper strength enhancement and ductility improvement because it experiences abrupt crushing of concrete. Also the volumetric ratio of ties is more important than the tie strength in enhancing the strength and improving the ductility of the column.

12. Bouafia, Iddir, Kachi and Dumontet, 2010 [6]

Boufia et al. studied circular and rectangular column sections and present an empirical stress - strain relation according to the confinement effects of various variables (compressive strength of the concrete, volumetric ratio, diameter, configuration and strength of the ties and the ratio and diameter of the longitudinal bars and section geometry) based on the stress-strain relation provided by Mander et al [18].

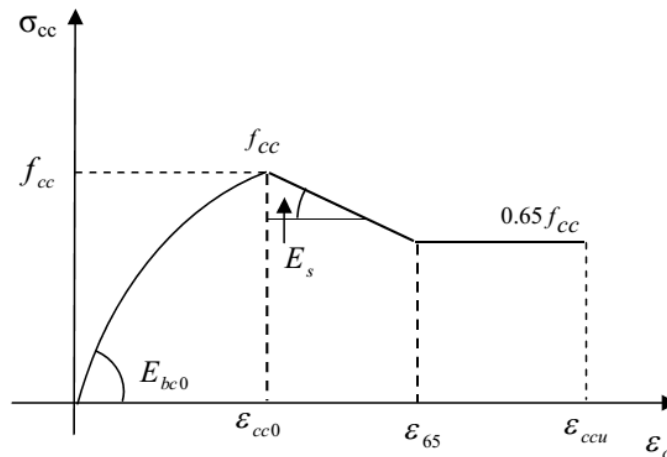

Figure 2.14 Stress- strain curve for confined concrete by Bouafia et al.

13. Investigations about confinement in Ethiopia

In Ethiopia experimental studies on effect of confinement were conducted using small scale specimens. Riyadh Zaidan [32] and Melat Ayele [19] conducted investigations about the role of confinement in reinforced concrete columns for their MSc. thesis.

Riyadh Zaidan focused on rectangular columns using a uniaxial compression test to investigate the confinement properties of concrete core due to rectilinear transverse reinforcement. The variables which investigated were amount, size, spacing and strength of lateral ties and size of longitudinal reinforcement. Whereas Melat Ayele conducted experiments on small scale RC columns which are confined by steel wire mesh and by transverse reinforcements of cross and overlapping ties. Based on the experimental and analytical investigations the researchers concluded that confinement has a considerable ductility and strength enhancement effect on reinforced concrete columns.

Several researchers performed experimental and analytical investigations on confined concrete as explained above and propose a stress-strain model based on their results. All the researchers agree that confinement can enhance the strength of the concrete and the main variables which affect the lateral pressure are the concrete strength, distribution of longitudinal steel, volumetric

ratio, spacing, configuration and yield stress of the transverse reinforcement. But the proposed stress-strain models are different for the researchers which are due to the difference in conditions when conducting the experiments such as the number of variables included, whether the test is on full scale or small scale, the type of cross section (circular, rectangular), the transverse steel configuration (spiral, hoops, cross ties) and the concrete strength used.

Generally, the researchers concluded that confinement is improved if:

- The transverse reinforcements are placed in relatively close spacing
- The volume of transverse reinforcement to the volume of concrete core increased
- Additional supplementary overlapping hoops or cross ties are included
- The yield strength of the transverse reinforcement increased
- The longitudinal bars are well distributed around the perimeter
- Spirals or circular hoops are used instead of rectangular ties

2.4. Code Provisions for Confinement

The effects of confinement on the strength gain through the requirement of minimum lateral reinforcement have already been considered in some building codes. However, this strength gain is used only for the compensation for the possible strength loss due to the spalling of concrete cover. The design criterion adopted in ACI 318 for column confinement is based on the premise that confined columns should maintain their concentric load carrying capacities even after spalling of concrete cover [39].

The equation for required area of rectangular hoops, as given in ACI code is based on the equation for spirals derived by Richart et al [31].

$$f_{cc} = f_{cp} + 4.1f_l$$

where, f_{cc} = strength of confined concrete, f_{cp} = compressive strength of plain concrete and f_l = passive lateral pressure obtained from the transverse reinforcement.

The Eurocode -2 provide a stress –strain model considering the effect of confinement and states that confinement of concrete results in a modification of the effective stress-strain relationship: higher strength and higher critical strains are achieved, and confinement can be generated by adequately closed links or cross ties which reach the plastic condition due to the lateral extension of the concrete.

The Euro code has specified the maximum limit of lateral reinforcement spacing for compensation of concrete cover spalling in ductility class of medium structures as;

Uniaxial Interaction Chart of Reinforced Concrete Column Confined by Transverse Reinforcement

$$s = \min \{ Bc/2, 175, 8Db \}$$

Where, Bc is the minimum dimension of the concrete core (to the centreline of the hoops); and Db is the minimum diameter of the longitudinal bars.

The distance between consecutive longitudinal bars engaged by hoops or cross-ties does not exceed 200 mm. For hoops used as transverse reinforcement in columns closed stirrups with 135° hooks and extensions of length $10Dbw$ shall be used.

Where, D_{bw} is the diameter of the transverse reinforcement.

2.5. RC Column Design Chart

2.5.1. Axial Force- Bending Moment Interaction

Almost all compression members in concrete structures are subjected to moments in addition to axial loads. These may be due to misalignment of the load on the column or may result from the column resisting a portion of the unbalanced moments at the ends of the beams supported by the columns [43].

When a member is subjected to combined axial compression and bending it is usually convenient to replace the axial load and moment with equal load applied at an eccentricity $e=M/P$. Those columns having a small eccentricity generally characterized by compression over the entire section and fail by crushing of the concrete. Whereas columns of large eccentricity will be subjected to tension on the part of the section and fail by yielding of the steel on the side furthest from the load.

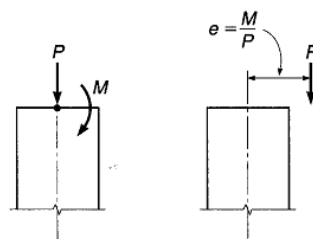

Figure 2.15 Equivalent eccentricity

Due to the presence of the bending moment, the axial force resistance of the column will reduce. Several pairs of failure strengths of axial force and bending moment (P_u , M_u) can be determined for a column with a specific percentage of longitudinal reinforcement steel bars assuming different positions of the neutral axis. The diagram which is drawn by using these pairs of points is known as interaction diagram. The interaction diagram is a surface which

Uniaxial Interaction Chart of Reinforced Concrete Column Confined by Transverse Reinforcement

defines the maximum capacity of compression members that are subjected to axial force and bending moments.

The interaction diagram depends on the concrete cross sectional area, the material properties (strain and stress) and the amount and distribution of reinforcements used. Each concrete section with a specific reinforcement distribution is characterized by a unique interaction diagram representing failure at the maximum strain. The interaction diagrams will be prepared using non-dimensional parameters, this would help to get several possible cross-sections with the respective longitudinal reinforcement bars for the given load. A group of non-dimensional interaction diagrams will give column design chart.

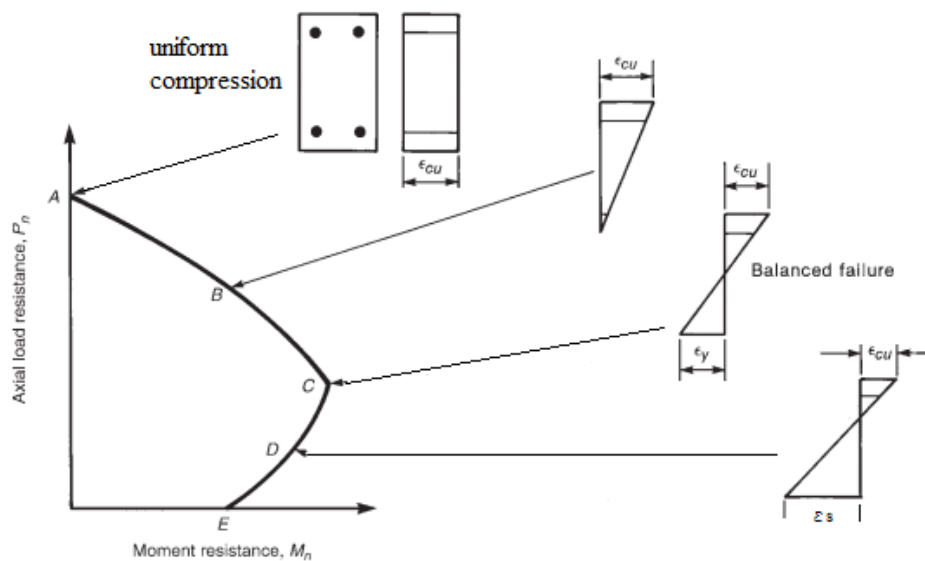

Figure 2.16 Strain distributions in reinforced concrete column interaction chart

[Source: Wight and MacGregor]

Once the interaction diagram for a section is obtained three possible load conditions can be defined:

1. The load condition coincides with the interaction diagram curve, represents the ultimate capacity.
2. The load condition located inside the interaction diagram curve, will not cause failure in the section.
3. The load condition located outside the interaction diagram curve, causes failure in the section.

2.5.2. Confinement Effect on Interaction Diagram

The effects of confinement directly influence the shape and magnitude of the stress - strain curve of concrete. This in turn will affect the compressive force. The increase of the compressive force of concrete will automatically improve the nominal capacity of a column subjected to axial load (P_u) and bending moment (M_u), or in other words, the interaction diagram of the column is enlarged [40].

Durga and Rama [10] have investigated the effect of lateral confinement on a reinforced concrete column in terms of load-moment interaction. The load-moment interaction curves are developed by considering confined stress-strain models and compared with the load-moment interaction curve for unconfined concrete. To investigate the amount of capacity gain in axial load and bending moment due to the confinement effects, analytical study was conducted for a uniaxial eccentrically loaded column with a rectangular cross-section with different stress-strain models and the interaction diagrams are shown below. The increase in compressive force of concrete will automatically improve the nominal capacity of a column subjected to axial force and bending moment, or in other words, the interaction diagram of the column is enlarged.

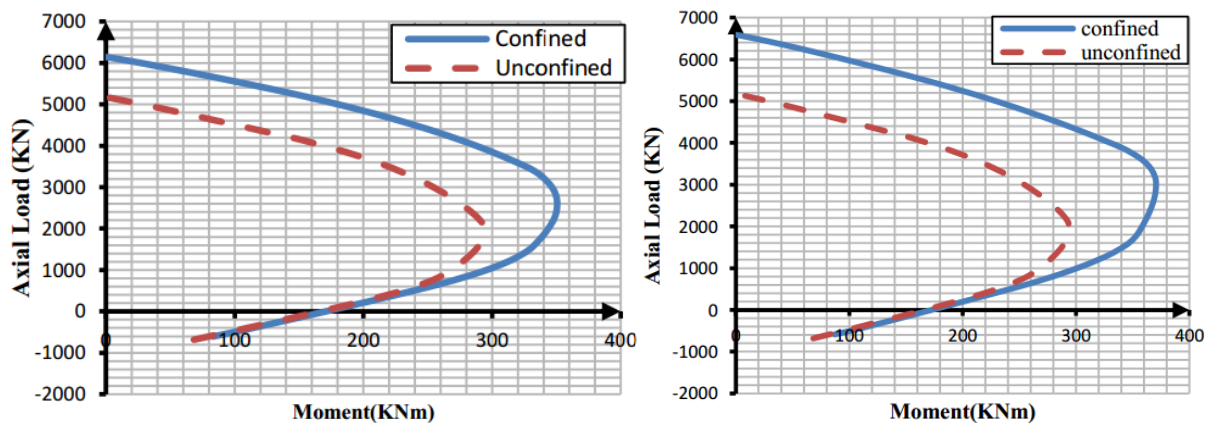

a. Modified Kent and Park model

b. Hong Han Model

Figure 2.17 Comparison of confined and unconfined interaction diagram of concrete column

[Source: Durga and Rama]

Durga and Rama concluded that the confinement produced by the lateral reinforcement only affect the compression controlled region of the column section. The load moment interaction diagram for confined concrete almost coincides with the unconfined concrete in the tension controlled region.

Tavio et al. [40] investigated the effect of lateral confinement on the column capacity and an analytical study is carried out. Both the strength gain in concrete core and the loss of strength in

Uniaxial Interaction Chart of Reinforced Concrete Column Confined by Transverse Reinforcement

the cover are considered in the analytical models to exhibit the remaining strength. To show the strength gain due to confinement they plot interaction diagrams for a specific column using different confined concrete stress- strain models and the axial force – bending moment interaction chart shows in figure 2.19. Based on their investigation the researchers reported that there is a capacity gain in axial load and bending moment of confined concrete column compared to that of the unconfined one, particularly in the compression controlled region, after the mobilization of strength gain in the concrete core to compensate the loss of strength in the concrete cover. Even though, the codes ignore the effect of confinement on the strength gain due to the conservative consideration for the design purposes, with the remaining capacity gain found due to confinement effects, a more economical reinforced concrete column can be expected to resist higher axial load and bending moment by maintaining its size without any enlargement, particularly for lower-story columns which are dominated by the axial load rather than flexure.

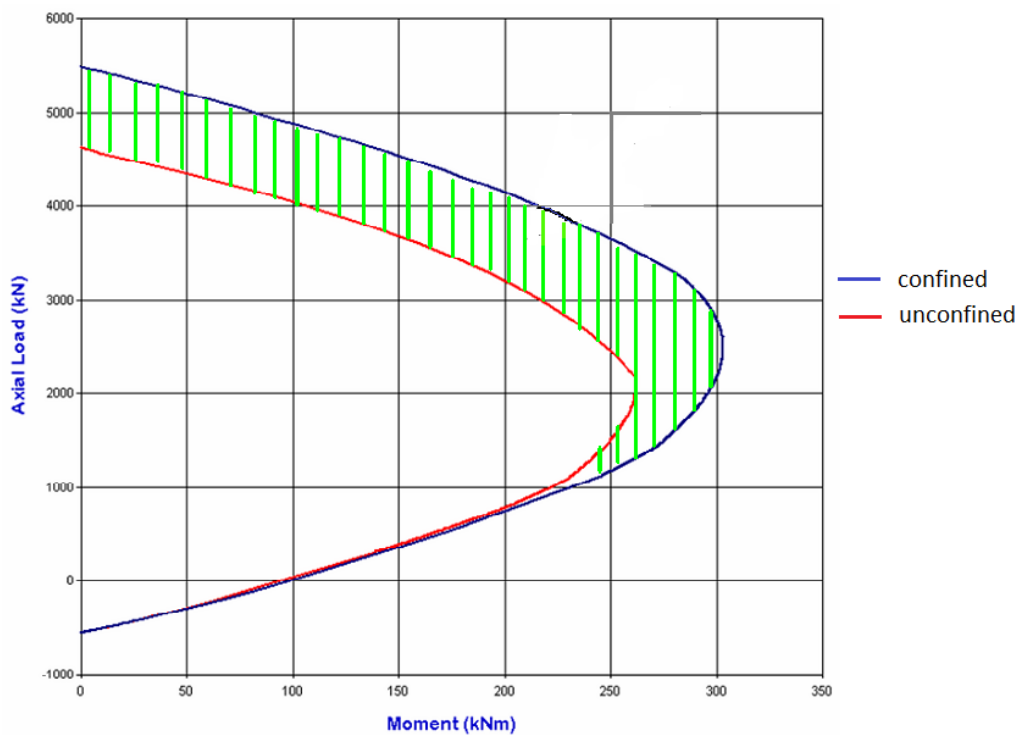

Figure 2.18 Capacity gain due to confinement [Source: Tavio et al.]

CHAPTER THREE

RESEARCH METHODOLOGY

The effect of confinement due to transverse reinforcement on the axial force- bending moment interaction of reinforced concrete column is determined analytically and the interaction diagram of a confined concrete column is compared with the unconfined one. The stress- strain model given in Euro code 2 and EBCS 2: EN for confined concrete is used. The transverse reinforcement size, spacing, yield strength and configuration, compressive strength of concrete, longitudinal reinforcement distribution and column cross section are the main variables which determine the lateral pressure applied as confinement. A uniaxial column interaction chart is prepared using the confined stress-strain model with different strain distributions by varying the ratio of neutral axis depth to column height. The column axial force- bending moment capacities, which are expressed in non-dimensional form to use for any column section are determined from the stress resultant of the internal forces of the section for several neutral axis depth ratios and computed using C++ programming language. For a reinforced concrete column under axial compression and uniaxial bending, the neutral axis depth ratio is taken from the smallest (gives pure bending) to the maximum (gives pure compression) with very small increment to obtain a smooth curve. Six column section configurations shown in Figure 3.15 are selected (circular spiral and hoop, rectangular perimeter tie, perimeter tie with single and double cross tie and overlapping tie) which are easy for construction and usually used for uniaxial bending. Based on the results of the comparison for economy, general design charts for selected sections are prepared.

3.1. Reinforced Concrete Section

3.1.1. Basic Assumptions in Ultimate Limit State

Assumptions made for determining ultimate resistance of a member for flexure and axial force according to Euro Code 2 are:

1. A section which is plane before bending remains plane after bending. This implies strains across the section are linearly varying.
2. The strain in the reinforcement is identical to the strain in the adjacent concrete. This implies there is no slip between steel bars and the adjacent concrete (compatibility of strains)
3. Tensile strength of concrete is ignored. The reinforcement assumed to take all the tension due to flexure.

4. The maximum compressive stain in concrete is taken to be 0.0035 in bending and 0.002 in axial compression for unconfined concrete.
5. The maximum tensile strain in the reinforcement is taken to 0.025.

3.1.2. Stress- Strain Relation

a. Concrete

For design purposes, the Euro Code 2 provides idealized stress-strain diagrams in predicting the ultimate strength of the sections which is a parabola-rectangle stress-strain diagram for unconfined concrete in compression as shown in Figure 3.1.

This work is only for normal strength concrete (concrete strength less than or equal to C 50/60).

$$\sigma_c = f_{cd} \left[1 - \left(1 - \frac{\epsilon_c}{\epsilon_{c2}} \right)^n \right] \quad \text{for } 0 \leq \epsilon_c \leq \epsilon_{c2}$$

$$\sigma_c = f_{cd} \quad \text{for } \epsilon_{c2} \leq \epsilon_c \leq \epsilon_{cu2}$$

$n=2$, for concrete strength $\leq C50/60$

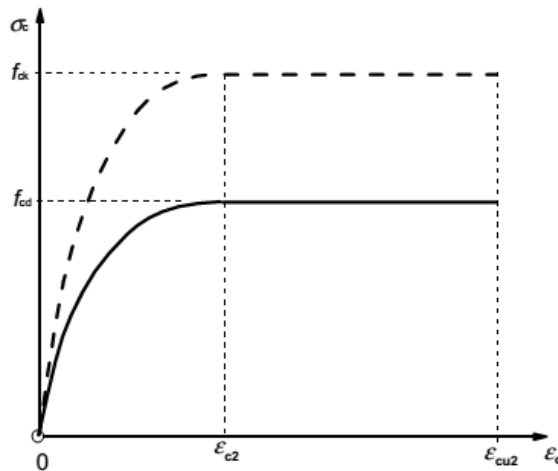

Figure 3. 1 Design stress-strain relation of unconfined concrete

f_{cd} is the ultimate design strength of concrete, which is calculated from the characteristic cylindrical strength of concrete, f_{ck} .

$$f_{cd} = 0.85 \frac{f_{ck}}{\gamma_c}$$

γ_c is the partial safety factor for the strength of concrete

For confined concrete, the stress- strain model given in Euro Code-2, as shown in Figure 3.2 is used.

Uniaxial Interaction Chart of Reinforced Concrete Column Confined
by Transverse Reinforcement

$$f_{ck,c} = f_{ck} (1.0 + 5.0 \sigma_2 / f_{ck}) , \quad \text{for } \sigma_2 \leq 0.05 f_{ck}$$

$$f_{ck,c} = f_{ck} (1.25 + 2.5 \sigma_2 / f_{ck}) , \quad \text{for } \sigma_2 > 0.05 f_{ck}$$

$$\epsilon_{c2,c} = \epsilon_{c2} (f_{ck,c} / f_{ck})^2$$

$$\epsilon_{cu2,c} = \epsilon_{cu2} + 0.2 \sigma_2 / f_{ck}$$

where $\sigma_2 (= \sigma_3)$ is the effective lateral compressive stress at the ULS due to confinement

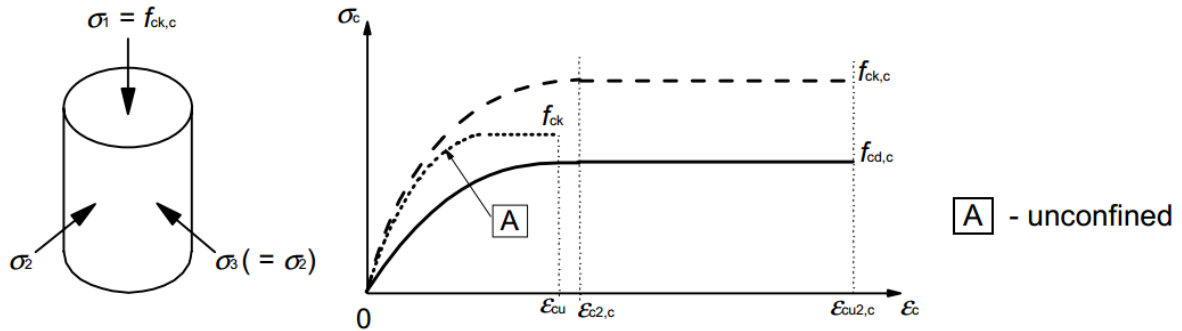

Figure 3.2 Stress-strain relationship for design of confined concrete

b. Reinforcing Steel

For reinforcing steel two alternative stress-strain models are given in Eurocode -2; which are an inclined top branch with a strain limit of ϵ_{ud} and a horizontal top branch without the need to check the strain limit.

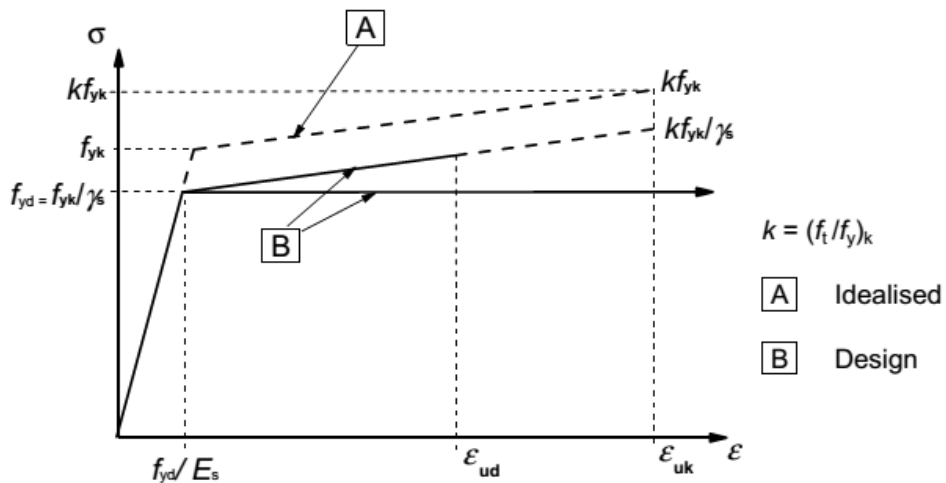

Figure 3.3 Stress-strain model of reinforcing steel

$E_s = 200$ Gpa, is elastic Modulus of reinforcing steel

γ_σ is the partial safety factor of reinforcing steel

In this work the reinforcing steel stress-strain model of the horizontal top branch is used.

3.1.3. Strain Distribution of Reinforced Concrete Section in Ultimate Limit State

The strain distribution shown in Figure 3.4 shall be assumed to pass through one of the three points A, B or C and used in this work.

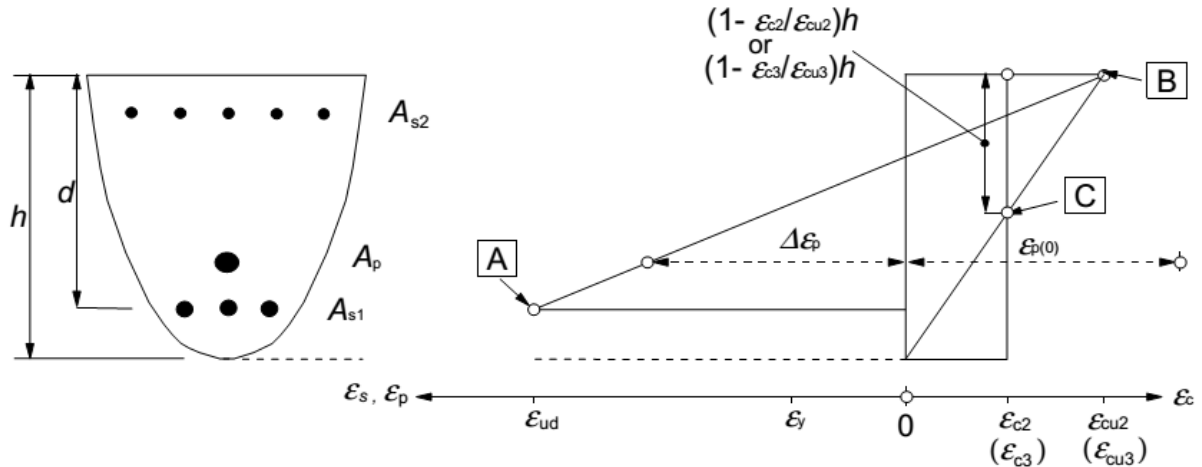

- A** - reinforcing steel tension strain limit
- B** - concrete compression strain limit
- C** - concrete pure compression strain limit

Figure 3.4 Strain distributions in ultimate limit state

The Euro Code sets the reinforcing steel tension strain limit (point A) which is 0.025 taken in this work. For unconfined the concrete compression strain limit (point B) to be 0.0035. The concrete compression strain limit (point C) is also 0.002 which has to be checked at $3h/7$ for normal strength concrete.

3.2. Reinforced Concrete Column Interaction Chart

The graph plotted with axial force and bending moment is referred to as an interaction diagram. Points on the lines plotted in the interaction diagram represent combinations of axial force and bending moment corresponding to the resistance of the section.

3.2.1. Stress Resultant

Interaction diagrams for columns are generally computed by assuming a series of strain distributions, each corresponding to a particular point on the interaction curve, and computing the corresponding values of P_u and M_u . Once enough such points have been computed, the results are plotted as an interaction diagram.

Uniaxial Interaction Chart of Reinforced Concrete Column Confined by Transverse Reinforcement

The location of the neutral axis is selected, and the strains in each level of reinforcement are computed from the strain distribution which used to compute the size of the compression stress block and the stress in each layer of reinforcement. The force in the concrete, F_c and the steel layers, F_{si} are computed by multiplying the stresses with the area on which they act. The total compressive force on concrete and its point of application is determined by integration of the stress strain diagram for different cases. Finally, the axial force, P_u is computed by summing the individual forces in the concrete and steel.

$$P_u = F_c + \sum_1^n F_{si} \quad (3.1)$$

The resultant bending moment also computed by summing the moments of these forces about the geometric centroid of the cross section.

$$M_u = F_c * z_c + \sum_1^n F_{si} * z_i \quad (3.2)$$

Where,

z_c and z_i are the lever arms of the concrete force and the reinforcement steels respectively.

These values represent one point on the interaction diagram. Other points on the interaction diagram can be generated by selecting other values for the depth to the neutral axis from the extreme compression fiber.

The resultant normal force on the compressed concrete zone can be obtained by integrating the stress distribution over the compressed area.

$$F_c = \iint \sigma_c dA \quad (3.3)$$

Where σ_c is the stress in the concrete and which can be determined from the idealized stress - strain relationship for concrete.

$$\sigma_c = f_{cd} \left[1 - \left(1 - \frac{\epsilon_c}{\epsilon_{c2}} \right)^2 \right] \quad (3.4)$$

The location of F_c can be determined by finding the centroid of the stress distribution with reference to the neutral axis.

$$Y = \frac{\iint \sigma_c y dA}{F_c} \quad (3.5)$$

3.2.2. General Reinforced Concrete Column Interaction Diagram

In reinforced concrete column design the ultimate section capacity varies with neutral axis depth and the strain profile cannot be generalized in a single equation, but there are generally

two cases: 1) when the neutral axis is within the section and 2) when the neutral axis is outside of the section.

a) Rectangular Section

Case 1: when the neutral axis is within the section

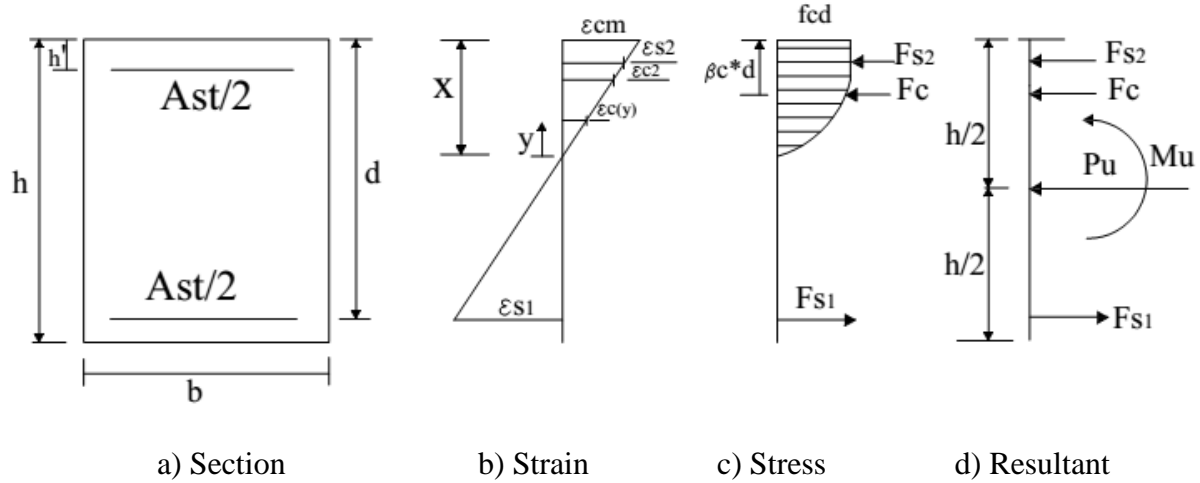

Figure 3.5 Stress-strain distribution for rectangular section when the neutral axis is within the section

From the strain diagram shown in Figure 3.5:

$$\epsilon_c (y) = \epsilon_{cm} \frac{y}{X}$$

$$\epsilon_{s1} = \epsilon_{cm} \frac{X-d}{X} \quad \text{and} \quad \epsilon_{s2} = \epsilon_{cm} \frac{X-h'}{X}$$

The steel strains are used to determine the stresses.

$$f_{s1} = E_s \epsilon_{s1} \leq f_{yd}, \quad \text{and} \quad f_{s2} = E_s \epsilon_{s2} \leq f_{yd}$$

$$x_1 = \frac{\epsilon_{c2}}{\epsilon_{cm}} X,$$

$$\sigma_c = K_c f_{cd} \left[1 - \left(1 - \frac{\epsilon_c}{\epsilon_{c2}} \right)^2 \right]$$

$$\sigma_c = k_c f_{cd} \left[2 \frac{\epsilon_c}{\epsilon_{c2}} - \left(\frac{\epsilon_c}{\epsilon_{c2}} \right)^2 \right]$$

$$\sigma_c = k_c f_{cd} \left[2 \frac{\epsilon_{cm}}{\epsilon_{c2}} \frac{y}{X} - \left(\frac{\epsilon_{cm}}{\epsilon_{c2}} \frac{y}{X} \right)^2 \right]$$

$$F_c = K_c \left\{ \int_0^{x_1} b \sigma_c + f_{cd} b (X - x_1) \right\} = K_c \alpha_c d b f_{cd}$$

Uniaxial Interaction Chart of Reinforced Concrete Column Confined
by Transverse Reinforcement

$$\alpha_c = \frac{3\epsilon_{cm} - \epsilon_{c2}}{\epsilon_{cm}} \frac{x}{d} \quad (3.6a)$$

$\beta_c^* d = X - Y$, $\beta_c^* d$ is the distance to the compressive force from the extreme compression fiber, $Y = \frac{\int_0^x b \sigma_c}{F_c}$, Y is the centroid of the concrete compressive force from the neutral axis

$$M_c = K_c \left\{ \int_0^{x_1} b y \sigma_c + f_{cd} b (x - x_1) \frac{(x+x_1)}{2} \right\} = K_c \alpha_c d b f_{cd} \left(\frac{h}{2} - d \beta_c \right)$$

$$\beta_c = \frac{6\epsilon_{cm}^2 - 4\epsilon_{cm} \epsilon_{c2} + \epsilon_{c2}^2}{4\epsilon_{cm}(3\epsilon_{cm} - \epsilon_{c2})} \frac{x}{d} \quad (3.6b)$$

Case 2: when the neutral axis is outside of the section

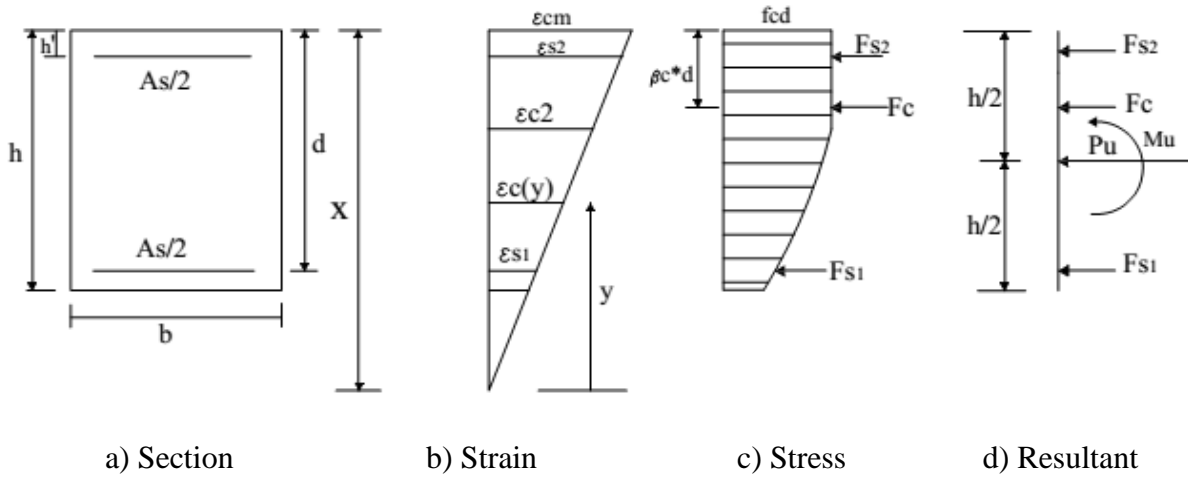

Figure 3.6 Stress-strain distribution for rectangular section when the neutral axis is outside of the section

$$\epsilon_c(y) = \epsilon_{cm} \frac{y}{X}$$

$$F_c = K_c \left\{ \int_0^{y_2} b \sigma_c dy + \left(1 - \frac{\epsilon_{c2}}{\epsilon_{cu2}}\right) h b f_{cd} \right\} = K_c \alpha_c d b f_{cd}$$

After computing the definite integral,

$$\alpha_c = \frac{1}{189} \frac{h}{d} \left(-64 \left(\frac{\epsilon_{cm}}{\epsilon_{c2}} \right)^2 + 128 \frac{\epsilon_{cm}}{\epsilon_{c2}} + 125 \right) \quad (3.7a)$$

The distance to F_c from the extreme compression fiber, $\beta_c^* d$ is:

$$\beta_c^* d = X - Y$$

$$\beta_c = \left\{ 0.5 - \frac{40}{7} \left(\frac{(2\epsilon_{cm} - 2\epsilon_{c2})^2}{125\epsilon_{c2}^2 + 128\epsilon_{cm}\epsilon_{c2} - 64\epsilon_{cm}^2} \right) \right\} \frac{h}{d} \quad (3.7b)$$

Uniaxial Interaction Chart of Reinforced Concrete Column Confined
by Transverse Reinforcement

Therefore the internal forces should be in equilibrium with the external applied forces.

$$P_u = F_c + F_{s1} + F_{s2}, \quad F_c = K_c \alpha_c d b f_{cd}, \quad F_{s1} = A_{s1} f_{s1}, \quad F_{s2} = A_{s2} f_{s2}$$

For symmetrical section, $A_{s1} = A_{s2} = \frac{A_{st}}{2}$

$$P_u = K_c \alpha_c d b f_{cd} + \frac{A_{st}}{2} f_{s1} + \frac{A_{st}}{2} f_{s2} \quad (3.8a)$$

$$M_u = F_c (z_c) + F_{s1} (z_1) + F_{s2} (z_2)$$

Where $z_c = \frac{h}{2} - \beta_c d$, $z_1 = z_2 = \frac{h}{2} - h'$, $h' = h - d$

$$M_u = K_c \alpha_c d b f_{cd} \left(\frac{h}{2} - \beta_c d \right) + \frac{A_{st}}{2} f_{s1} \left(\frac{h}{2} - h' \right) + \frac{A_{st}}{2} f_{s2} \left(\frac{h}{2} - h' \right) \quad (3.8b)$$

To prepare a design chart, it is better to express equations 3.8a and 3.8b in terms of non-dimensional form as follows:

$$v = \frac{P_u}{f_{cd} A_c} = K_c \frac{\alpha_c f_{cd} b d}{f_{cd} A_c} + \frac{f_{s1} A_{st}}{2 f_{cd} A_c} + \frac{f_{s2} A_{st}}{2 f_{cd} A_c}$$

$$v = K_c \alpha_c \frac{d}{h} + \frac{\omega}{2} m_1 + \frac{\omega}{2} m_2 \quad (3.9a)$$

$$\mu = \frac{M_u}{f_{cd} A_c h} = K_c \frac{\alpha_c f_{cd} b d \left(\frac{h}{2} - \beta_c d \right)}{f_{cd} A_c} + \frac{f_{s1} A_s \left(\frac{h}{2} - h' \right)}{2 f_{cd} A_c} + \frac{f_{s2} A_s \left(\frac{h}{2} - h' \right)}{2 f_{cd} A_c}$$

$$\mu = K_c \alpha_c \frac{d}{h} \left(\frac{h}{2} - \beta_c d \right) + \frac{\omega}{2} m_1 \left(\frac{h}{2} - h' \right) + \frac{\omega}{2} m_2 \left(\frac{h}{2} - h' \right) \quad (3.9b)$$

For rectangular column with intermediate longitudinal bars the configuration shown in Figure 3.7 is used. The concrete compression stress block parameters are unchanged.

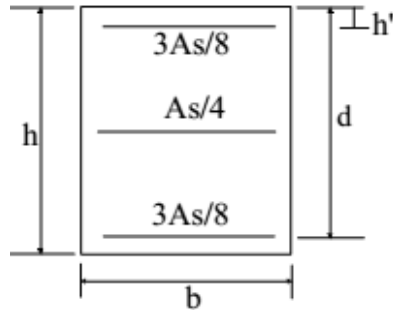

Figure 3.7 Rectangular column section with intermediate longitudinal bars

The non-dimensional axial force and bending moments are:

$$\nu = K_c \alpha_c \frac{d}{h} + \frac{3\omega}{8} m_1 + \frac{3\omega}{8} m_2 + \frac{\omega}{4} m_3 \quad (3.10a)$$

$$\mu = K_c \alpha_c \frac{d}{h} \left(\frac{h}{2} - \beta_c d \right) + \frac{3\omega}{8} m_1 \left(\frac{h}{2} - h' \right) + \frac{3\omega}{8} m_2 \left(\frac{h}{2} - h' \right) \quad (3.10b)$$

To draw the interaction diagram, the non-dimensional ratios ν and μ first calculated by varying the neutral axis depth ratio $\frac{x}{h}$ for a fixed mechanical reinforcement ratio, ω .

$\omega = \frac{A_{st} f_{yd}}{A_c f_{cd}}$, the range for mechanical steel ratio is based on the limits of the reinforcement area allowed in Euro code-2 which are $A_{s, \min} = 0.002 A_c$ and $A_{s, \max} = 0.04 A_c$.

For C-60 and S-300, $\omega_{\min} = 0.02$

For C-25 and S-500, $\omega_{\max} = 1.53$

Therefore, the interaction diagrams prepared in this work are for mechanical reinforcement ratio, ω from 0 to 1.6.

C++ programming language is used to generate the non-dimensional column axial force- bending moment capacities. Sample program used in this work for rectangular columns is shown in appendix A.

For unconfined column section: $\varepsilon_{c2} = 2\%$, $\varepsilon_{cu2} = 3.5\%$ and $K_c = 1$

A design chart for rectangular unconfined column section is shown in Figure 3.8 for a sample.

Uniaxial Interaction Chart of Reinforced Concrete Column Confined
by Transverse Reinforcement

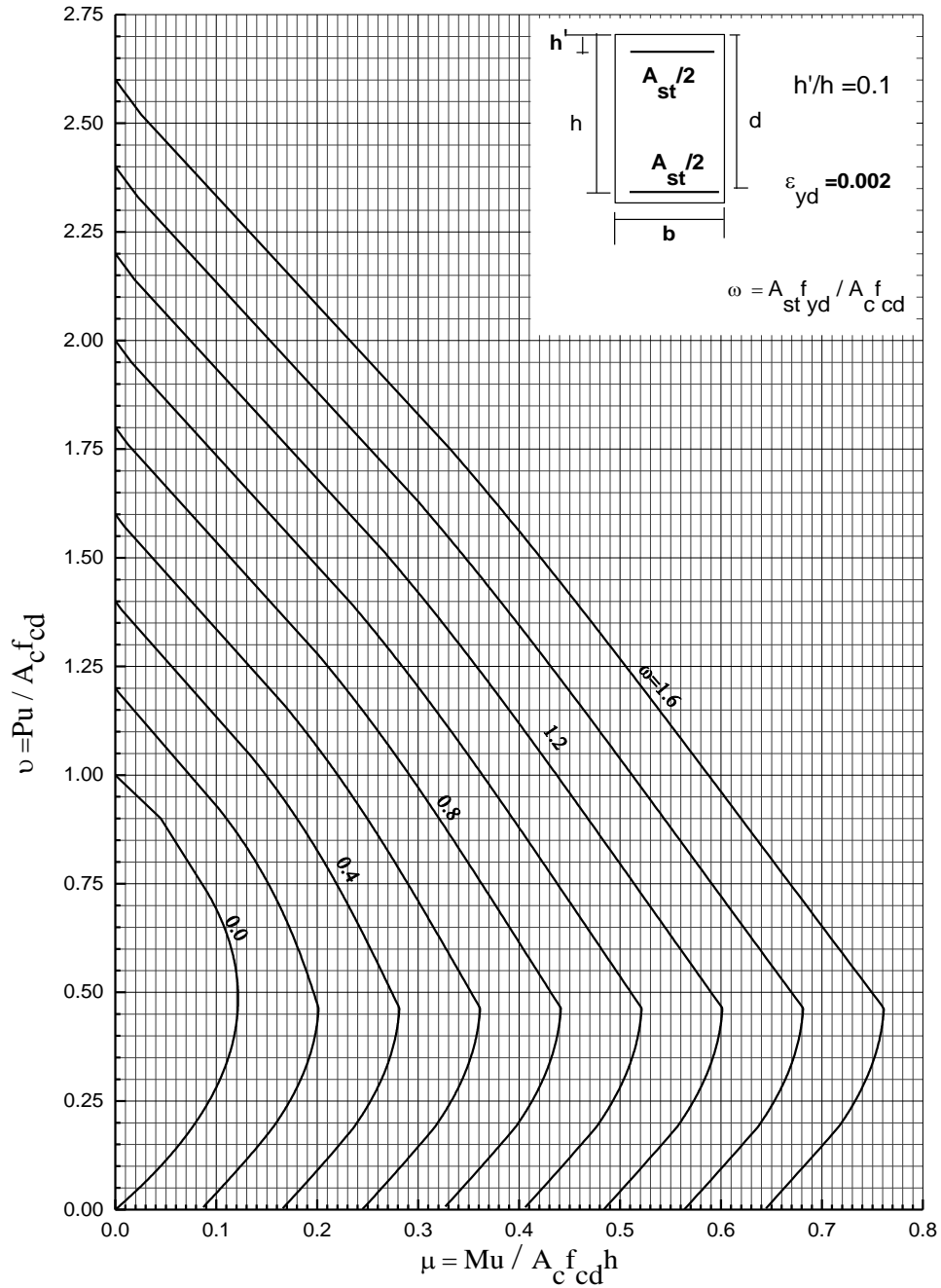

Figure 3.8 Sample Uniaxial column design chart for rectangular unconfined section

b) Circular column section

The strain-compatibility solution described in the preceding section can also be used to calculate the points on an interaction diagram for a circular column. The depth to the neutral axis is used to calculate the strains from the assumed strain diagram by using similar triangles. The resulting compression zone is a segment of a circle having depth x . To compute the compressive force and its moment about the centroid of the column, it is necessary to be able to

Uniaxial Interaction Chart of Reinforced Concrete Column Confined
by Transverse Reinforcement

compute the area and centroid of the segment. These terms can be expressed as a function of the angle.

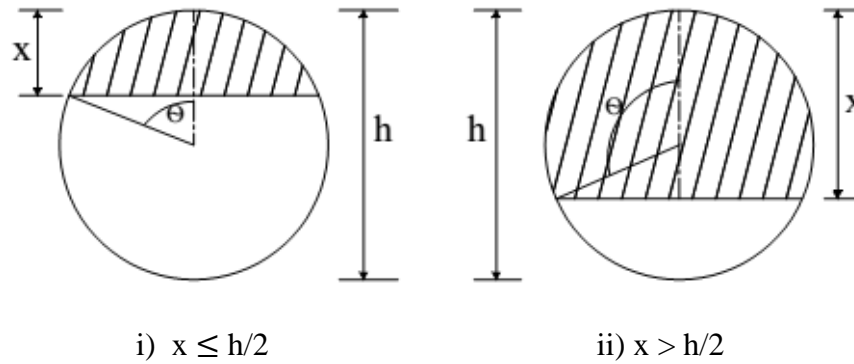

Figure 3.9 Segments in compression for circular columns under uniaxial bending

The inclination of the segment from the vertical as shown in Figure 3.9 is given by:

$$\theta = \cos^{-1}\left[\frac{\frac{h-x}{2}}{\frac{h}{2}}\right], \quad x \leq h/2 \quad (3.11a)$$

$$\theta = 180^\circ - \cos^{-1}\left[\frac{\frac{h-x}{2}}{\frac{h}{2}}\right], \quad x > h/2 \quad (3.11b)$$

The shape of the interaction diagram of a circular column is affected by the number of bars and their orientation relative to the direction of the neutral axis. In this work the interaction diagrams are prepared numerically using large number reinforcement bars distributed uniformly throughout the perimeter of the section and it can be used for any circular columns having at least six longitudinal bars.

In computing the compressive stress block for the rectangular-parabolic stress –strain model of circular section the origin of the coordinates can be taken at the depth of the neutral axis, in that case the section will be an off center circle. But in this work the origin is taken at the center of the circle and the stress- strain equation for the parabolic stress distribution is modified (Figure 3.10 and equation 3.12) to consider the change in its zero stress point from the neutral axis depth to the center of the circle.

Uniaxial Interaction Chart of Reinforced Concrete Column Confined
by Transverse Reinforcement

I) When the neutral axis is within the section

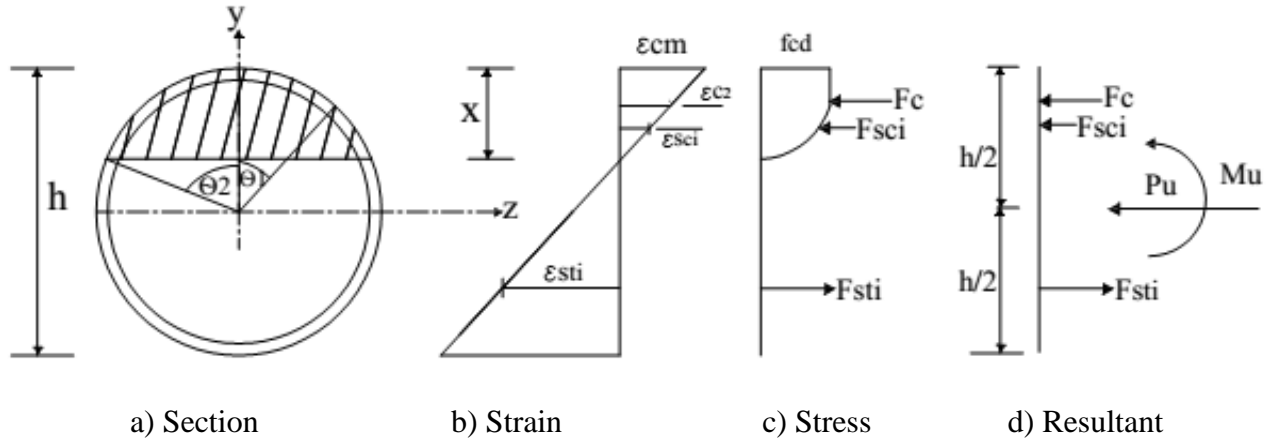

Figure 3.10 Stress-strain distribution when the neutral axis is outside of the section

The concrete compressive stress is given by:

$$\sigma_c = K_c f_{cd} \left[\varepsilon_c(y) - \frac{1}{4}(\varepsilon_c(y))^2 \right], \quad \varepsilon_c \leq \varepsilon_{c2}$$

$$\sigma_c = K_c f_{cd}, \quad \varepsilon_c > \varepsilon_{c2}$$

Using triangular similarity of the strain diagram shown in Figure 3.10:

$$\varepsilon_{si} = \frac{\varepsilon_{cm}}{x} y_{si}, \quad y_{si} \text{ is the distance from the neutral axis to the } i^{\text{th}} \text{ reinforcement bar}$$

$$\varepsilon_c(y) = \frac{\varepsilon_{cm}}{x} \left(y + x - \frac{h}{2} \right), \quad \text{the strain with respect to the centroid of the circle}$$

$$\sigma_c = K_c f_{cd} \left[\frac{2\varepsilon_{cm}}{\varepsilon_{c2}x} \left(y + x - \frac{h}{2} \right) - \frac{\varepsilon_{cm}^2}{\varepsilon_{c2}^2 x^2} \left(y + x - \frac{h}{2} \right)^2 \right] \quad (3.12)$$

The resultant compressive force of the rectangular stress portion, F_{cr} as shown in Figure 3.10 is;

$$F_{cr} = K_c f_{cd} A_{cr},$$

A_{cr} is the area of compressive force of the rectangular stress portion.

$$A_{cr} = h^2 \frac{\theta_1 - \sin \theta_1 \cos \theta_1}{4}$$

$$\theta_1 = \cos^{-1} \left(\frac{\frac{h}{2} - x_2}{\frac{h}{2}} \right)$$

$$x_2 = x - \frac{\varepsilon_{c2}}{\varepsilon_{cm}} x$$

The moment of the rectangular stress portion about the centroid of the section is;

$$M_{cr} = K_c \frac{h^3 \sin^3 \theta_1}{12} f_{cd}$$

The resultant compressive force for the parabolic stress portion is;

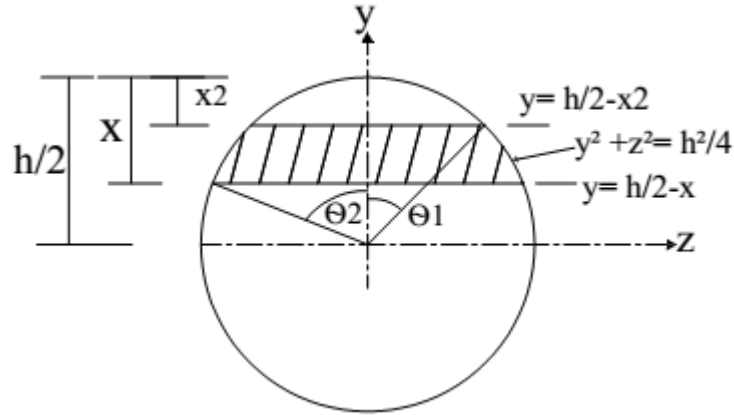

Figure 3.11 The concrete section under parabolic compressive stress when the neutral axis is within the section

$$F_{cp} = \int_{y_1}^{y_2} \int_{z_1}^{z_2} \sigma_c dz dy$$

Where y_1 , y_2 , z_1 and z_2 are the integration limits for the parabolic stress distribution as shown in Figure 3.11.

$$y_1 = h/2 - x = h/2 \cos \theta_2$$

$$y_2 = h/2 - x^2 = h/2 \cos \theta_1$$

Since the section is symmetrical along Y axis

$$z_1 = 0$$

$$z_2 = \sqrt{\frac{h^2}{4} - y^2}$$

$$\theta_2 = \cos^{-1}\left(\frac{\frac{h}{2} - x}{\frac{h}{2}}\right) \quad , h/2 \leq x$$

$$\theta_2 = 180^\circ - \cos^{-1}\left(\frac{\frac{h}{2} - x}{\frac{h}{2}}\right) \quad , h/2 > x$$

After computing the double integral the resultant force for the parabolic stress distribution is;

Uniaxial Interaction Chart of Reinforced Concrete Column Confined
by Transverse Reinforcement

$$F_{cp} = 2K_c \left\{ \frac{f_{cd} \pi h^2}{4} \left[\frac{8\epsilon_c m}{\pi \epsilon_c^2} \left(\frac{k_2 + 2k_3}{16} - \frac{(4k_1 + 3k_2 + 6k_3) h}{96} \frac{1}{x} \right) \right. \right. \\ \left. \left. + \frac{4\epsilon_c m^2}{\epsilon_c^2 \pi} \left(\frac{-(k_2 + 2k_3)}{16} + \frac{(4k_1 + 3k_2 + 6k_3) h}{48} \frac{1}{x} - \left(\frac{64k_1 + 24k_2 + 60k_3 + 3k_4}{1536} \frac{h^2}{x^2} \right) \right) \right] \right\}$$

Where, $K_1 = \sin^3 \theta_1 - \sin^3 \theta_2$

$$K_2 = \sin 2\theta_1 - \sin 2\theta_2$$

$$K_3 = \tan^{-1}(\cot \theta_1) - \tan^{-1}(\cot \theta_2)$$

$$K_4 = \sin 4\theta_1 - \sin 4\theta_2$$

$$K_5 = \sin^3 \theta_1 \cos^2 \theta_1 - \sin^3 \theta_2 \cos^2 \theta_2$$

$$F_c = F_{cp} + F_{cr}$$

Similarly the resultant moment for the parabolic stress portion about the centroid of the section is:

$$M_{cp} = \int_{y_1}^{y_2} \int_{z_1}^{z_2} y \sigma_c dz dy$$

$$M_{cp} = 2K_c \left\{ \frac{f_{cd} \pi h^3}{4} \left[\frac{8\epsilon_c m}{\epsilon_c^2 \pi} \left(-\frac{k_1}{24} - \frac{(32k_1 + 12k_3 + 3k_4) h}{915366} \frac{1}{x} \right) \right. \right. \\ \left. \left. + \frac{4\epsilon_c m^2}{\pi \epsilon_c^2} \left(\frac{k_1}{24} - \frac{(32k_1 + 12k_3 + 3k_4) h}{768} \frac{1}{x} - \left(\frac{112k_1 + 60k_3 + 15k_4 + 48k_5}{7680} \frac{h^2}{x^2} \right) \right) \right] \right\}$$

$$M_c = M_{cr} + M_{cp}$$

$$P_u = F_c + \sum_1^n F_{si}$$

$$M_u = M_c + \sum_1^n M_{si}$$

In non-dimensional form:

$$\nu = \frac{P_u}{f_{cd} A_c} = \frac{F_c}{f_{cd} A_c} + \sum_1^n \frac{f_{si} A_{st}}{n f_{cd} A_c}$$

$$\mu = \frac{M_u}{f_{cd} A_c h} = \frac{M_c}{f_{cd} A_c} + \sum_1^n \frac{f_{si} A_{st} \left(0.5 - \frac{h'}{h} \right) \cos \emptyset}{n f_{cd} A_c}$$

Where \emptyset the inclination of a reinforcement bar from the centroid of the section

$A_c = \frac{\pi h^2}{4}$, the concrete area, neglecting the displaced concrete by the reinforcement bars.

Uniaxial Interaction Chart of Reinforced Concrete Column Confined
by Transverse Reinforcement

Using the mechanical steel ratio $\omega = \frac{A_{st} f_{yd}}{A_c f_{cd}}$ and the steel stress ratios, $m_i = \frac{f_{si}}{f_{yd}}$

$$v = v_c + \sum_1^n \frac{\omega}{n} m_i \quad (3.13a)$$

$$\mu = \mu_c + \sum_1^n \frac{\omega}{n} m_i \left(0.5 - \frac{h'}{h}\right) \cos \phi \quad (3.13b)$$

$$v_c = Kc \left[\frac{\theta_1 - \sin \theta_1 \cos \theta_1}{\pi} + 2 \left\{ \frac{8 \epsilon_{cm}}{\pi \epsilon_c^2} \left(\frac{k_2 + 2k_3}{16} - \frac{(4k_1 + 3k_2 + 6k_3) h}{96 x} \right) + \frac{4 \epsilon_{cm}^2}{\pi \epsilon_c^2} \left(\frac{-(k_2 + 2k_3)}{16} + \frac{(4k_1 + 3k_2 + 6k_3) h}{48 x} - \left(\frac{64k_1 + 24k_2 + 60k_3 + 3k_4}{1536} \frac{h^2}{x^2} \right) \right) \right\} \right] \quad (3.14b)$$

$$\mu_c = Kc \left[\frac{\sin^3 \theta_1}{3\pi} + 2 \left\{ \frac{8 \epsilon_{cm}}{\pi \epsilon_c^2} \left(-\frac{k_1}{24} - \frac{(32k_1 + 12k_3 + 3k_4) h}{915366 x} \right) + \frac{4 \epsilon_{cm}^2}{\pi \epsilon_c^2} \left(\frac{k_1}{24} - \frac{(32k_1 + 12k_3 + 3k_4) h}{768 x} - \left(\frac{112k_1 + 60k_3 + 15k_4 + 48k_5}{7680} \frac{h^2}{x^2} \right) \right) \right\} \right] \quad (3.14b)$$

II) When the neutral axis is outside of the section

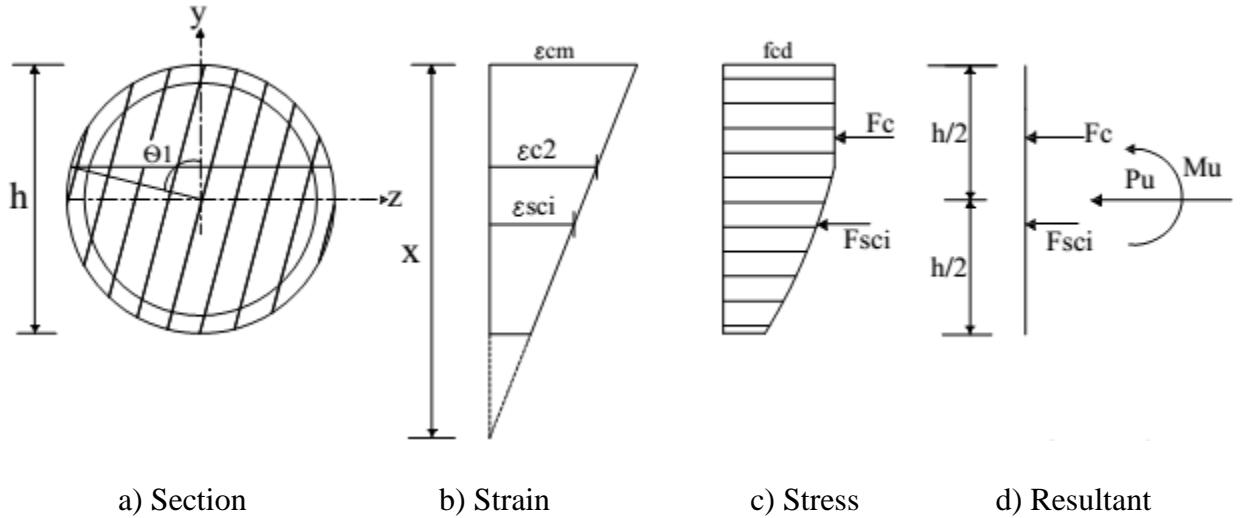

Figure 3.12 Stress-strain distribution for circular section when the neutral axis is outside of the section

For the rectangular stress portion as shown in Figure 3.12:

$$F_{cr} = Kc f_{cd} A_c, \quad A_c = \frac{h^2 (B - \sin B \cos B)}{4}, \quad \beta = \cos^{-1} \frac{\left(\frac{h}{2} - X\right)}{\frac{h}{2}} = 0.4544 \pi$$

$$F_{cr} = 0.40936 Kc \frac{f_{cd} \pi h^2}{4}$$

Uniaxial Interaction Chart of Reinforced Concrete Column Confined
by Transverse Reinforcement

The moment of the rectangular stress portion about the centroid of the section is:

$$M_{cr} = \frac{h^3 \sin^3 B}{12} f_{cd} = 0.10287 K_c \frac{f_{cd} \pi h^3}{4}$$

For the parabolic stress portion:

$$\sigma_c = K_c f_{cd} \left[\frac{2\epsilon_{cm}}{\epsilon_c x^2} \left(y + x - \frac{h}{2} \right) - \frac{\epsilon_{cm}^2}{\epsilon_c^2 x^2} \left(y + x - \frac{h}{2} \right)^2 \right]$$

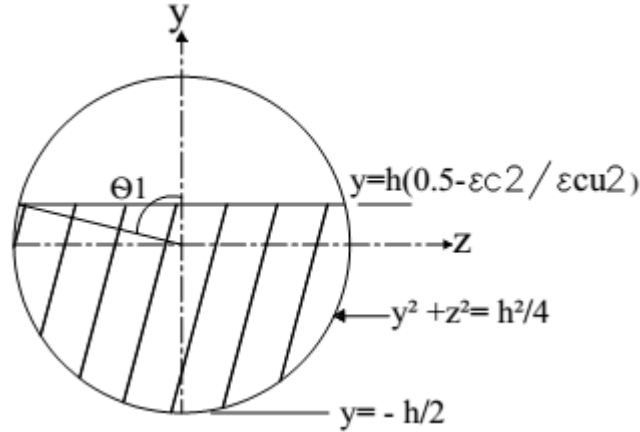

Figure 3.13 Circular column section under parabolic compressive stress when the neutral axis is outside of the section

$$F_{cp} = \int_{y_1}^{y_2} \int_{z_1}^{z_2} \sigma_c dz dy$$

Where y_1, y_2, z_1 and z_2 are the integration limits for the parabolic stress distribution.

$$y_1 = -h/2$$

$$y_2 = \left(\frac{1}{2} - \frac{\epsilon_c x^2}{\epsilon_{cu} x^2} \right) h$$

Since the section is symmetrical along Y axis

$$z_1 = 0$$

$$z_2 = \sqrt{\frac{h^2}{4} - y^2}$$

After computing the double integral:

$$F_{cp} = 2K_c \left\{ \frac{f_{cd} \pi h^2}{4} \left[\frac{8\epsilon_{cm}}{\pi \epsilon_c^2} \left(\frac{6.4944}{28} - 0.1564 \frac{h}{x} \right) + \frac{4\epsilon_{cm}^2}{\pi \epsilon_c^2} \left(-\frac{6.4944}{28} + 0.31274 \frac{h}{x} - 0.11072 \frac{h^2}{x^2} \right) \right] \right\}$$

$$F_c = F_{cp} + F_{cr}$$

Uniaxial Interaction Chart of Reinforced Concrete Column Confined
by Transverse Reinforcement

Similarly the moment of the parabolic stress portion about the centroid of the section is:

$$M_{cp} = \int_{y_1}^{y_2} \int_{z_1}^{z_2} y \sigma c \, dz \, dy$$

$$M_{cp} = 2 \left\{ \frac{f_{cd} \pi h^3}{4} \left[\frac{8 \epsilon c m}{\pi \epsilon c^2} \left(\frac{6.4944}{28} - 0.1564 \frac{h}{x} \right) + \frac{4 \epsilon c m^2}{\pi \epsilon c^2} \left(-\frac{6.4944}{28} + 0.31274 \frac{h}{x} - 0.11072 \frac{h^2}{x^2} \right) \right] \right\}$$

$$M_c = M_{cr} + M_{cp}$$

$$P_u = F_c + \sum_1^n F_{si}$$

$$M_u = M_c + \sum_1^n M_{si}$$

In non-dimensional form:

$$v = \frac{P_u}{f_{cd} A_c} = \frac{F_c}{f_{cd} A_c} + \sum_1^n \frac{f_{si} A_{st}}{n f_{cd} A_c}$$

$$\mu = \frac{M_u}{f_{cd} A_c h} = \frac{M_c}{f_{cd} A_c} + \sum_1^n \frac{f_{si} A_{st} \left(0.5 - \frac{h'}{h} \right) \cos \phi}{n f_{cd} A_c}$$

$$v = v_c + \sum_1^n \frac{\omega}{n} m_i \quad (3.15a)$$

$$\mu = \mu_c + \sum_1^n \frac{\omega}{n} m_i \left(0.5 - \frac{h'}{h} \right) \cos \phi \quad (3.15b)$$

$$v_c = K_c \left\{ 0.4094 + 2 \left[\frac{8 \epsilon c m}{\pi \epsilon c m} \left(\frac{6.4944}{28} - 0.1564 \frac{h}{x} \right) + \frac{4 \epsilon c m^2}{\pi \epsilon c^2} \left(-\frac{6.4944}{28} + 0.31274 \frac{h}{x} - 0.11072 \frac{h^2}{x^2} \right) \right] \right\} \quad (3.16a)$$

$$\mu_c = K_c \left\{ 0.10287 + 2 \left[\frac{8 \epsilon c m}{\pi \epsilon c^2} \left(\frac{6.4944}{28} - 0.1564 \frac{h}{x} \right) + \frac{4 \epsilon c m^2}{\pi \epsilon c^2} \left(-\frac{6.4944}{28} + 0.31274 \frac{h}{x} - 0.11072 \frac{h^2}{x^2} \right) \right] \right\} \quad (3.16b)$$

A sample uniaxial design chart for unconfined reinforced concrete circular column is shown in Figure 3.14.

Uniaxial Interaction Chart of Reinforced Concrete Column Confined
by Transverse Reinforcement

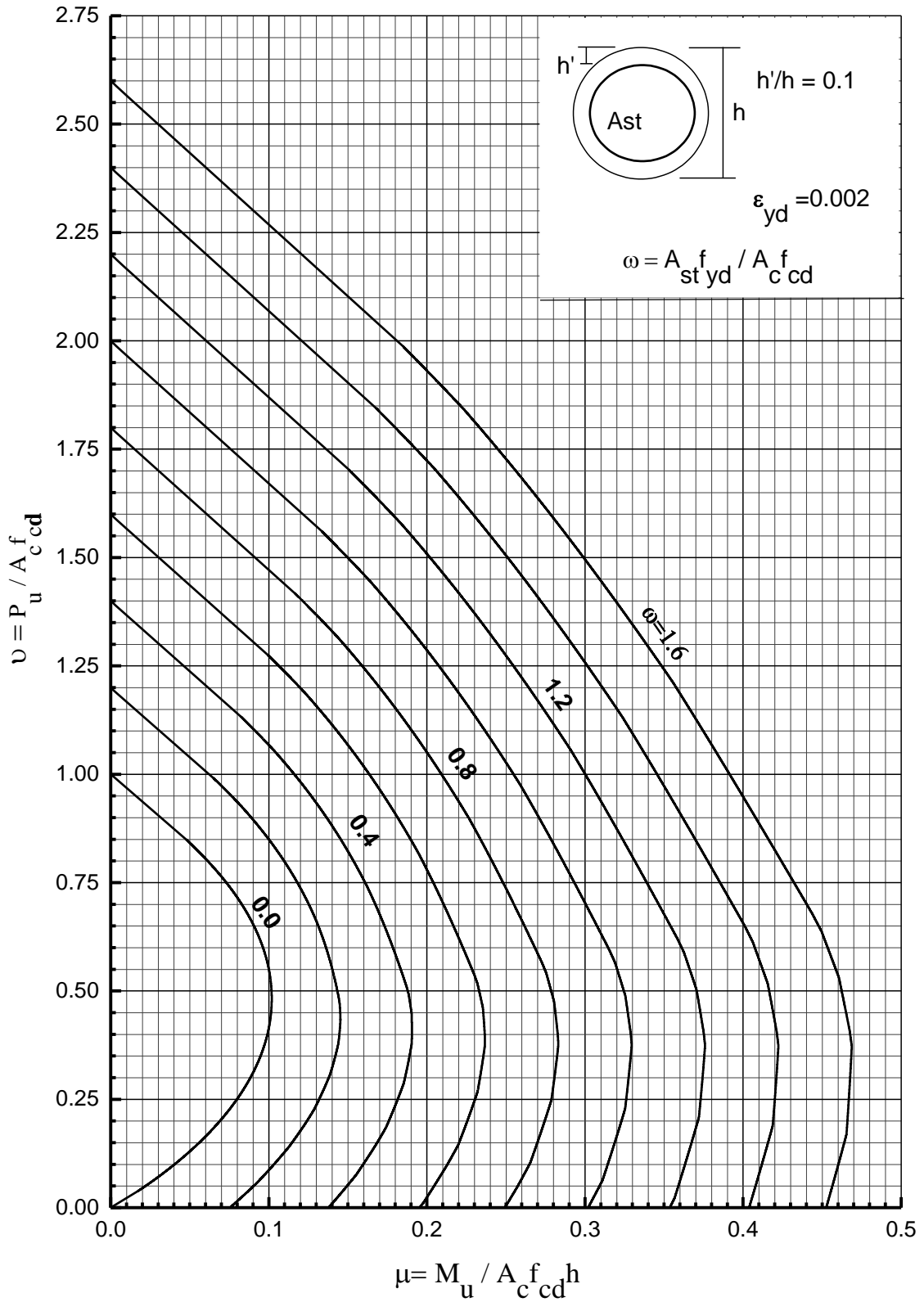

Figure 3.14 Sample Uniaxial column design chart of unconfined circular section

3.3. RC Confined Column Interaction Diagram

3.3.2. Confinement in Reinforced Concrete Column

Compression tests on plain unconfined concrete cylinders have revealed that as the cylinders approach failure, the concrete develops significant internal micro-cracking parallel to the direction of loading accompanied by lateral expansion strains. The introduction of adequate transverse reinforcing steel to confine concrete under compressive loading affects the expansion behaviour of concrete. When the concrete is axially loaded, the transverse reinforcement is hardly stressed until the load at which concrete develops appreciable lateral strains. At these strains, the concrete contained within the transverse reinforcement begins to expand outwards under continued axial load and bears against the transverse steel. The transverse steel tends to resist the lateral expansion of the concrete, creating a reactive confining pressure against the concrete core within the boundary of the transverse reinforcement.

3.3.3. Minimum Lateral Reinforcement for RC Columns

When the loading capacity of RC column is reached, the column will be longitudinally contracted and laterally expanded with internal micro-cracks. The strain in the compression zone of the section increased slowly until crushing of concrete started at the top. The maximum lateral load approximately coincided with the start of crushing and subsequent spall off cover concrete. At this time, the ties resist the high expansion pressure, and the proper confinement by lateral ties, leads to the enhancement of axial load-carrying capacity. The lateral reinforcement provided should be at least adequate to replace the loss of the column capacity due to concrete cover spall off. The quantity of lateral reinforcement required for confinement increases when the concrete cover thickness ratio (h'/h) increases. This is due to for high h'/h ratio the column losses significant strength when the cover concrete spalls. The amount of lateral reinforcement required to compensate this loss is:

Strength loss due to spalling of cover concrete = $f_{cd} (A_g - A_c)$

Strength gain due to confinement = $K_1 f_l A_c$

Where A_g and A_c are the gross and core concrete areas and K_1 is the lateral pressure coefficient, which is 5 as given in Euro code-2; f_l is the lateral pressure which is a function of the lateral reinforcement type as shown in Figure 3.15.

$$F_{cd} (A_g - A_c) = 5 f_l A_c \quad (3.17)$$

Uniaxial Interaction Chart of Reinforced Concrete Column Confined
by Transverse Reinforcement

For circular columns

$$f_{cd} (A_g - A_c) = 5 \frac{2A_p f_{yd}}{S D_c} A_c$$

Rearranging and solve for lateral reinforcement volumetric ratio;

$$\rho_s \text{ min} = 0.4 \frac{f_{cd}}{f_{yd}} \left(\frac{A_g}{A_c} - 1 \right) \quad (3.18)$$

ρ_s is the ratio of the volume of lateral reinforcement to the volume of the concrete core.

For circular sections;

$$\rho_s = \frac{\pi D_c A_p}{S \frac{\pi D_c^2}{4}} = \frac{4 A_p}{S D_c} \quad (3.19)$$

Similarly for rectangular sections

$$\rho_s = \frac{4 A_p}{S B_c} \quad (3.20)$$

The minimum lateral reinforcement volumetric ratio required to compensate cover concrete spall off, for rectangular sections shown in Figure 3.15 are;

$$\rho_{s2} \text{ min} = 0.54 \frac{f_{cd}}{f_{yd}} \left(\frac{A_g}{A_c} - 1 \right) \quad (3.21a)$$

$$\rho_{s3} \text{ min} = 0.36 \frac{f_{cd}}{f_{yd}} \left(\frac{A_g}{A_c} - 1 \right) \quad (3.21b)$$



$$\rho_{s4} \text{ min} = 0.3 \frac{f_{cd}}{f_{yd}} \left(\frac{A_g}{A_c} - 1 \right) \quad (3.21c)$$

$$\rho_{s5} \text{ min} = 0.32 \frac{f_{cd}}{f_{yd}} \left(\frac{A_g}{A_c} - 1 \right) \quad (3.21d)$$

In general the lateral reinforcement required to replace the loss of concrete cover calculated using equations 3.18, and 3.21a to 3.21d are shown in Table 3.1 for each transverse reinforcement configurations considered in this work.

Uniaxial Interaction Chart of Reinforced Concrete Column Confined
by Transverse Reinforcement

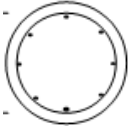
Table 3.1 Minimum lateral reinforcement volumetric ratio required

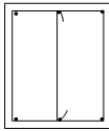
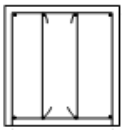
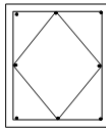
	Minimum lateral reinforcement volumetric ratio, $\rho_{s=m} * f_{cd} / f_{yd}$				
	Section type	h'/h			
		0.05	0.1	0.15	0.2
1		0.0675	0.1536	0.266	0.4163
2		0.0911	0.2074	0.359	0.562
3		0.0607	0.13827	0.2394	0.3747
4		0.05062	0.1152	0.2	0.3122
5		0.054	0.123	0.213	0.333

The lateral reinforcement for strength enhancement to carry loads beyond columns ultimate capacity is considered only if the lateral reinforcement volumetric ratio of the column is greater than the minimum given in the Table 3.1.

3.3.4. Effective Confinement Pressure

The lateral confinement pressure for commonly used column sections under uniaxial bending are shown in Figure 3.15.

Uniaxial Interaction Chart of Reinforced Concrete Column Confined
by Transverse Reinforcement

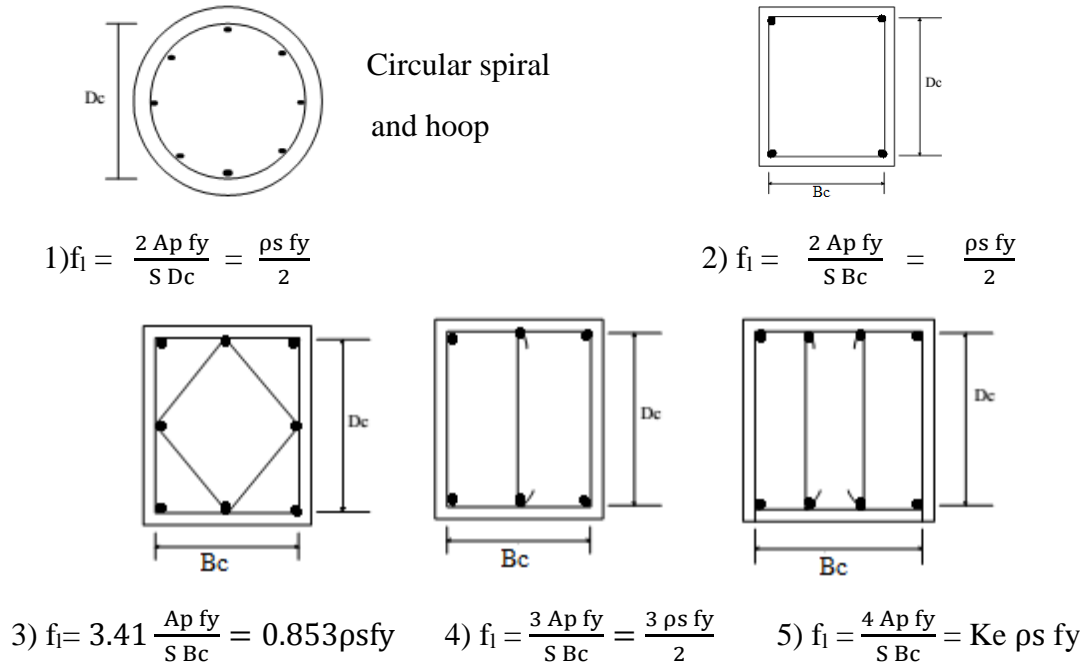

Figure 3.15 Lateral confinement pressure

For column sections which have different lateral pressures in the two principal directions due to tie configuration, the average of the two lateral pressures, f_{1a} is used.

$$f_{1a} = \frac{f_{1x} + f_{1y}}{2} \quad (3.22)$$

Since the whole section of the column is not effective for confinement the lateral pressure should be multiplied by an effective confinement coefficient to obtain the effective lateral confinement pressure, f_{1e} .

$$f_{1e} = K_e f_{1a}$$

The effective lateral confinement pressures for the column sections shown in Figure 3.15 are:

$$f_{1e1} = K_e \frac{2 A_p f_y}{S D_c} = K_e \frac{\rho_s f_y}{2} \quad (3.23a)$$

$$f_{1e2} = K_e \frac{2 A_p f_y}{S B_c} = K_e \frac{\rho_s f_y}{2} \quad (3.23b)$$

$$f_{1e3} = K_e 3.41 \frac{A_p f_y}{S B_c} = \frac{3.41}{4} \rho_s f_y K_e \quad (3.23c)$$

$$f_{1e4} = K_e \frac{3 A_p f_y}{S B_c} = K_e \frac{5 \rho_s f_y}{8} \quad (3.23d)$$

$$f_{1e5} = K_e \frac{4 A_p f_y}{S B_c} = \frac{3}{4} K_e \rho_s f_y \quad (3.23e)$$

The effective confinement pressure from the transverse reinforcement is dependent on the vertical spacing of the lateral reinforcements and the column cross section. But this work is preparation of design charts for RC confined columns, the confinement pressure should be

Uniaxial Interaction Chart of Reinforced Concrete Column Confined
by Transverse Reinforcement

expressed independently of unknown terms. Therefore, the conservative effective confinement coefficient given by Paultre and Legeron [28] is used.

For rectangular sections

$$K_e = 1.0 \frac{A_c}{A_g} \left(1 - \frac{2}{n}\right) \quad (3.24a)$$

For Circular spirals

$$K_e = 0.9 + 0.05 \frac{A_c}{A_g} \quad (3.24b)$$

For circular hoops

$$K_e = \left(0.9 + 0.05 \frac{A_c}{A_g}\right)^2 \quad (3.24c)$$

Table 3.2 Effective confinement coefficient

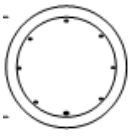
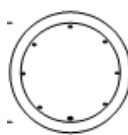
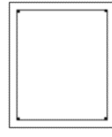
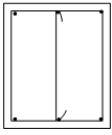
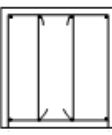
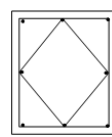
	Effective confinement coefficient ($K_e=A_e/A_c$)				
	Section type	h'/h			
		0.05	0.1	0.15	0.2
1	Spiral 	0.9428	0.9361	0.9300	0.9245
2	Hoop 	0.8888	0.8763	0.8650	0.8547
3		0.4492	0.3793	0.3153	0.2573
4		0.5989	0.5058	0.4204	0.3430
5		0.673805	0.568969	0.472992	0.385875
6		0.673805	0.568969	0.472992	0.385875

3.3.5. RC Confined Column Design Chart

The design compressive strength of the confined RC column according to Euro Code is;

$$f_{cd,c} = \text{minimum} \left\{ \begin{array}{l} f_{cd} \left(1 + \frac{5f_{le}}{f_{cd}} \right) \\ f_{cd} \left(1.125 + 2.5 * \frac{f_{le}}{f_{cd}} \right) \end{array} \right. = K_c f_{cd} \quad (3.25)$$

f_{cd} is the design compressive strength of unconfined concrete and let K_c is the strength enhancement factor.

$$K_c = \text{minimum} \left\{ \begin{array}{l} \left(1 + \frac{5f_{le}}{f_{cd}} \right) \\ \left(1.125 + 2.5 * \frac{f_{le}}{f_{cd}} \right) \end{array} \right. \quad (3.26)$$

For circular columns from equation 3.23a

$$f_{le} = K_e \frac{\rho_{sn} f_{yd}}{2}$$

$$\frac{f_{le}}{f_{cd}} = \frac{K_e \rho_{sn} f_{yd}}{2 f_{cd}} \quad (3.27)$$

K_e is the effective confinement coefficient, which is shown in Table 3.2 for different column configurations and h'/h ratio.

f_{yd} is the design yield strength of transverse steel

ρ_{sn} is the net lateral reinforcement volumetric ratio after deducting the minimum lateral reinforcement volumetric ratio ρ_{smin} , which is used as compensation for concrete cover spall off, from the total ρ_s .

$$\rho_{smin} = m * f_{cd} / f_{yd}$$

m is a coefficient given in Table 3.1 for different column configurations and h'/h ratio.

From equation 3.27

$$\frac{f_{le}}{f_{cd}} = \frac{K_e}{2} \left(4 \frac{A_p}{SD_c} - m \frac{f_{cd}}{f_{yd}} \right) \frac{f_{yd}}{f_{cd}} = \frac{K_e}{2} \left(4 \frac{A_p}{SD_c} \frac{f_{yd}}{f_{cd}} - m \right)$$

Let $h'' = D_c/h$ and mechanical ratio of lateral reinforcement, $\gamma = \frac{A_p f_{yd}}{S_h f_{cd}}$

$$\frac{f_{le}}{f_{cd}} = \frac{K_e}{2} \left(4 \frac{\gamma}{h''} - m \right) \quad (3.28)$$

$\frac{f_{le}}{f_{cd}}$ and the strength enhancement factor, K_c can be calculated for different values of γ

The strain for confined column according to Euro code-2 is given by;

Uniaxial Interaction Chart of Reinforced Concrete Column Confined
by Transverse Reinforcement

$$\varepsilon_{c2,c} = \varepsilon_{c2} \left(\frac{f_{cd,c}}{f_{cd}} \right)^2 = K_c^2 \varepsilon_{c2} \quad (3.29)$$

$$\varepsilon_{cu2,c} = \varepsilon_{c2} + 0.2 \frac{f_{le}}{f_{cd}} \quad (3.30)$$

Experimental investigators [6, 7, 17, 23, 24, 26, 36] show that columns confined by lateral reinforcements of the volumetric ratio less than 1% do not show considerable strength enhancement and for well confined column the maximum lateral load approximately coincided with the start of cracking of cover concrete. Beyond this point, tie strain increased rapidly, resulting in the yielding of steel. Shiekh and Tokluku [36] observed in column specimens with a volumetric ratio of less than 0.8% that lateral steel stress is much smaller than yield strength. There is no clear indication about the maximum optimal volumetric ratio, which should be used in reinforced confined concrete column but Pallewatta et al. [26] have taken that a volumetric ratio of 3% as medium and 6% as high.

In this work the lateral reinforcement volumetric ratio of 1% to 3% is used. The upper limit is taken based on the maximum possible lateral reinforcement which can be used for the selected configurations. The mechanical ratio of lateral reinforcement, γ is used to determine the lateral pressure in the column as confinement to find the strength enhancement, which is calculated from the lateral reinforcement volumetric ratio ρ_s and considers the material strengths in addition to the cross section properties of the column. For these volumetric reinforcement ratios, the mechanical ratio of lateral reinforcement, γ is between 3.5% and 16%.

Table 3.3 Strength enhancement factor for circular columns

$\gamma\%$ $\frac{A_p f_{yd}}{S_h f_{cd}}$	$h'/h = 0.1$							
	Circular hoop				Circular Spiral			
	f_{le}/f_{cd}	$K_c = \frac{f_{cd,c}}{f_{cd}}$	ε_{cu2}	$\varepsilon_{cu2,c}$	f_{le}/f_{cd}	$K_c = \frac{f_{cd,c}}{f_{cd}}$	ε_{cu2}	$\varepsilon_{cu2,c}$
3.5	0.0034	1.0170	2.0685	4.1792	0.0036	1.0181	2.0732	4.225
5	0.0250	1.1252	2.5323	8.5093	0.0267	1.1337	2.5709	8.851
7.5	0.0585	1.2713	3.2322	15.202	0.0625	1.2812	3.2832	16.00
10	0.0930	1.3576	3.6862	22.109	0.0993	1.3734	3.7729	23.375
13	0.1345	1.4612	4.2704	30.398	0.1436	1.4841	4.4055	32.239
16	0.1707	1.5517	4.8156	37.637	0.1823	1.5808	4.9980	39.968

Uniaxial Interaction Chart of Reinforced Concrete Column Confined
by Transverse Reinforcement

For rectangular column with perimeter type tie

$$f_{le} = K_e \frac{\rho_s f_y}{2}$$

$$\frac{f_{le}}{f_{cd}} = \frac{K_e}{2} \left(4 \frac{A_p}{S_{Bc}} - m \frac{f_{cd}}{f_{yd}} \right) \frac{f_{yd}}{f_{cd}} = \frac{K_e}{2} \left(4 \frac{A_p f_{yd}}{S_{Bc} f_{cd}} - m \right)$$

$$\frac{f_{le}}{f_{cd}} = \frac{K_e}{2} \left(4 \frac{\gamma}{h''} - m \right) \quad (3.31a)$$

For rectangular column with single cross tie

$$f_{le} = K_e \frac{5 \rho_s f_y}{8}$$

$$\frac{f_{le}}{f_{cd}} = \frac{5K_e}{8} \left(4 \frac{A_p}{S_{Bc}} - m \frac{f_{cd}}{f_{yd}} \right) \frac{f_{yd}}{f_{cd}} = \frac{5K_e}{8} \left(4 \frac{A_p f_{yd}}{S_{Bc} f_{cd}} - m \right)$$

$$\frac{f_{le}}{f_{cd}} = \frac{5K_e}{8} \left(4 \frac{\gamma}{h''} - m \right) \quad (3.31b)$$

For rectangular column with double cross tie

$$f_{le} = K_e \frac{3 \rho_s f_y}{4}$$

$$\frac{f_{le}}{f_{cd}} = \frac{3K_e}{4} \left(4 \frac{A_p}{S_{Bc}} - m \frac{f_{cd}}{f_{yd}} \right) \frac{f_{yd}}{f_{cd}} = \frac{3K_e}{2} \left(4 \frac{A_p f_{yd}}{S_{Bc} f_{cd}} - m \right)$$

$$\frac{f_{le}}{f_{cd}} = \frac{3K_e}{4} \left(4 \frac{\gamma}{h''} - m \right) \quad (3.31c)$$

For rectangular column with overlapping tie

$$f_{le} = K_e \frac{3.41 \rho_s f_y}{4}$$

$$\frac{f_{le}}{f_{cd}} = \frac{3.41K_e}{4} \left(4 \frac{A_p}{S_{Bc}} - m \frac{f_{cd}}{f_{yd}} \right) \frac{f_{yd}}{f_{cd}} = \frac{3.41K_e}{4} \left(4 \frac{A_p f_{yd}}{S_{Bc} f_{cd}} - m \right)$$

$$\frac{f_{le}}{f_{cd}} = \frac{3.41K_e}{4} \left(4 \frac{\gamma}{h''} - m \right) \quad (3.31d)$$

Table 3.4 Strength enhancement factor for rectangular columns with perimeter and single cross tie types

$\frac{\gamma\%}{\frac{A_p f_{yd}}{S_b f_{cd}}}$	h/h = 0.1							
	rectangle with perimeter tie				rectangle with single cross tie			
	f _{le} /f _{cd}	K _c = f _{cd,c} /f _{cd}	ε _{cu2}	ε _{cu2,c}	f _{le} /f _{cd}	K _c = f _{cd,c} /f _{cd}	ε _{cu2}	ε _{cu2,c}
3.5	-	-	-		0.005	1.0250	2.1015	4.5027
5	0.0031	1.0158	2.0639	4.1347	0.0184	1.0920	2.3849	7.1802
7.5	0.0165	1.0828	2.3449	6.8122	0.0407	1.2035	2.8971	11.642
10	0.0299	1.1497	2.6438	9.4897	0.0630	1.2825	3.2899	16.105
13	0.0460	1.2300	3.0261	12.702	0.0898	1.3495	3.6423	21.460
16	0.0620	1.2801	3.2778	15.915	0.1165	1.4164	4.0126	26.815

Uniaxial Interaction Chart of Reinforced Concrete Column Confined
by Transverse Reinforcement

Table 3.5 Strength enhancement factor for rectangular columns with perimeter and double cross tie types

$\frac{\gamma\%}{\frac{A_p f_{yd}}{S_b f_{cd}}}$	h/h= 0.1							
	rectangle with double cross tie				rectangle with overlapping tie			
	f_{le}/f_{cd}	$K_c = f_{cd,c}/f_{cd}$	ε_{cu2}	$\varepsilon_{cu2,c}$	f_{le}/f_{cd}	$K_c = f_{cd,c}/f_{cd}$	ε_{cu2}	$\varepsilon_{cu2,c}$
3.5	0.0126	1.063	2.261	6.033	0.012	1.060	2.250	5.932
5	0.0307	1.153	2.662	9.648	0.032	1.163	2.707	10.04
7.5	0.0608	1.277	3.262	15.67	0.066	1.292	3.340	16.88
10	0.0909	1.352	3.658	21.69	0.101	1.377	3.797	23.73
13	0.1271	1.442	4.163	28.92	0.142	1.480	4.384	31.95
16	0.1632	1.533	4.701	36.15	0.183	1.583	5.014	40.17

Table 3.6 Strength enhancement factor for rectangular columns of perimeter type tie with h'/h of 0.05 and 0.15

$\frac{\gamma\%}{\frac{A_p f_{yd}}{S_b f_{cd}}}$	Rectangular with perimeter type tie							
	h'/h=0.05				h'/h=0.15			
	f_{le}/f_{cd}	$K_c = f_{cd,c}/f_{cd}$	ε_{cu2}	$\varepsilon_{cu2,c}$	f_{le}/f_{cd}	$K_c = f_{cd,c}/f_{cd}$	ε_{cu2}	$\varepsilon_{cu2,c}$
5	0.0168	1.0842	2.351	6.870	-	-	-	-
7.5	0.0314	1.1571	2.677	9.784	0.0026	1.013	2.053	4.030
10	0.0459	1.2299	3.025	12.69	0.0148	1.074	2.308	6.471
13	0.0634	1.2836	3.295	16.19	0.0295	1.147	2.633	9.401
16	0.0809	1.3273	3.523	19.69	0.0441	1.220	2.980	12.33

The uniaxial design diagrams for a reinforced concrete confined column can be prepared using the procedure explained in topic 3.3.2 for rectangular and circular columns, using the appropriate concrete strength factor, K_c and concrete strains, ε_{c2} and ε_{cu2} which are shown in Tables 3.3 to 3.6.

Sample uniaxial design chart for rectangular reinforced concrete column confined with perimeter ties is shown in Figure 3.16.

Uniaxial Interaction Chart of Reinforced Concrete Column Confined
by Transverse Reinforcement

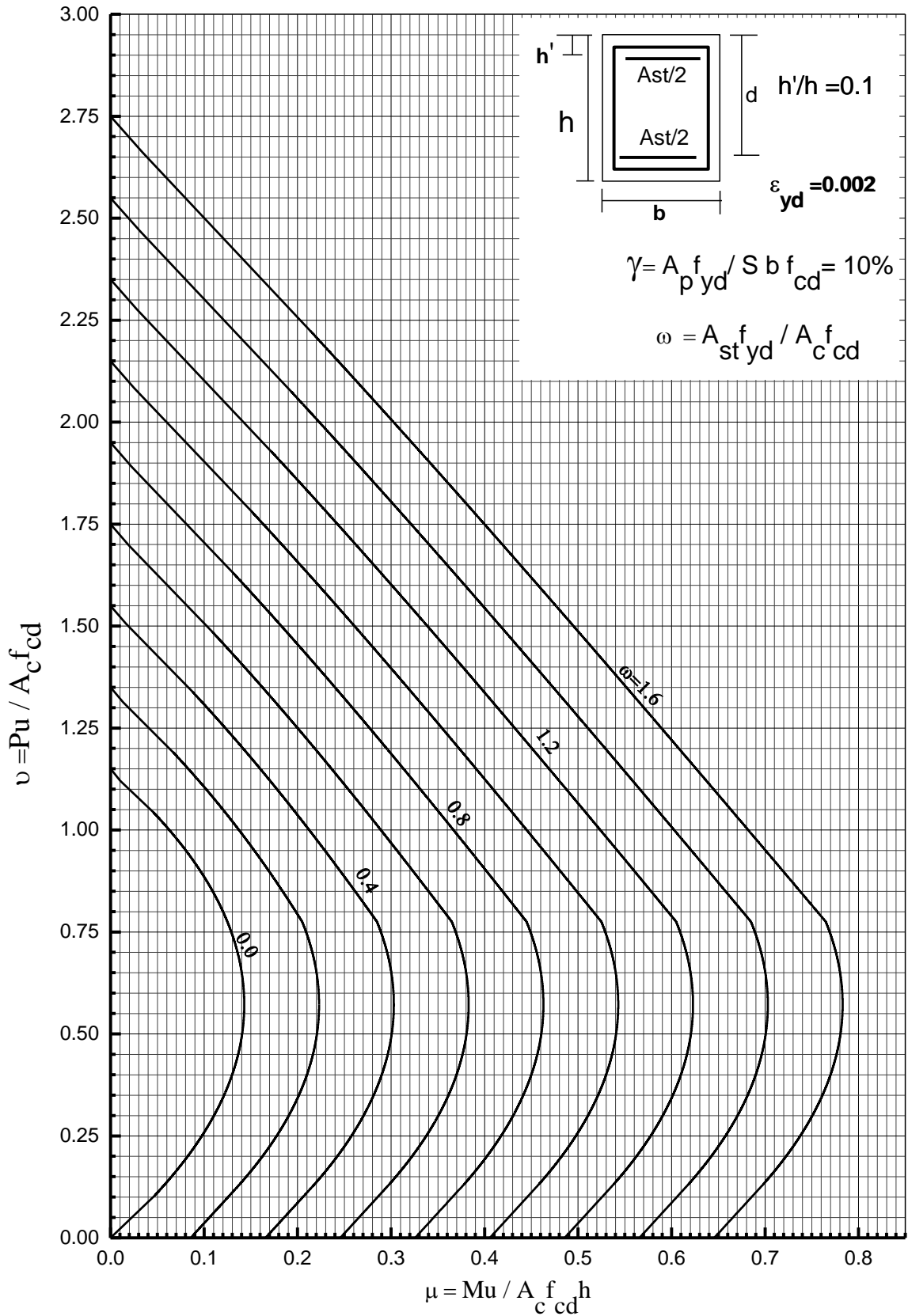

Figure 3.16 Sample Uniaxial interaction chart of confined reinforced concrete rectangular column

CHAPTER FOUR

RESULTS AND DISCUSSIONS

To investigate the effect of confinement on load-moment interaction curve of RC column, an analytical study is conducted for different transverse reinforcement configurations such as hoop and spiral for circular columns and perimeter tie, perimeter with cross tie and overlapping tie for rectangular columns were considered. The stress- strain model given in Euro code 2 for confined concrete is used. Due to confinement the concrete will gain large deformation capacity and its strength will be enhanced.

4.1. Verification of the Uniaxial Design Charts

In order to check the validity of the uniaxial interaction charts of the confined reinforced concrete column developed in this work, chart of unconfined concrete column by setting the strength enhancement factor, K_c as 1 is compared to the existing unconfined concrete column provided in EBCS-2, Part 2 1995. The verification is done using different points of the non-dimensional axial force and bending moment (μ, ν) to find the required mechanical reinforcement ratio, ω . The unconfined concrete column design chart as shown in Figure 4.1 which is prepared in this work is compared with the corresponding existing column design chart as shown in Appendix A. The two design charts give same ω and the diagrams are similar which justifies the procedure used in this work to prepare the design charts is correct.

Table 4.1 Mechanical reinforcement ratio required for verification

	Non-dimensional bending moment, μ	Non-dimensional axial force, ν	Required mechanical reinforcement ratio, ω
1	0.22	1.0	0.6
2	0.44	0.4	0.8
3	0.3	1.4	1.2

Uniaxial Interaction Chart of Reinforced Concrete Column Confined
by Transverse Reinforcement

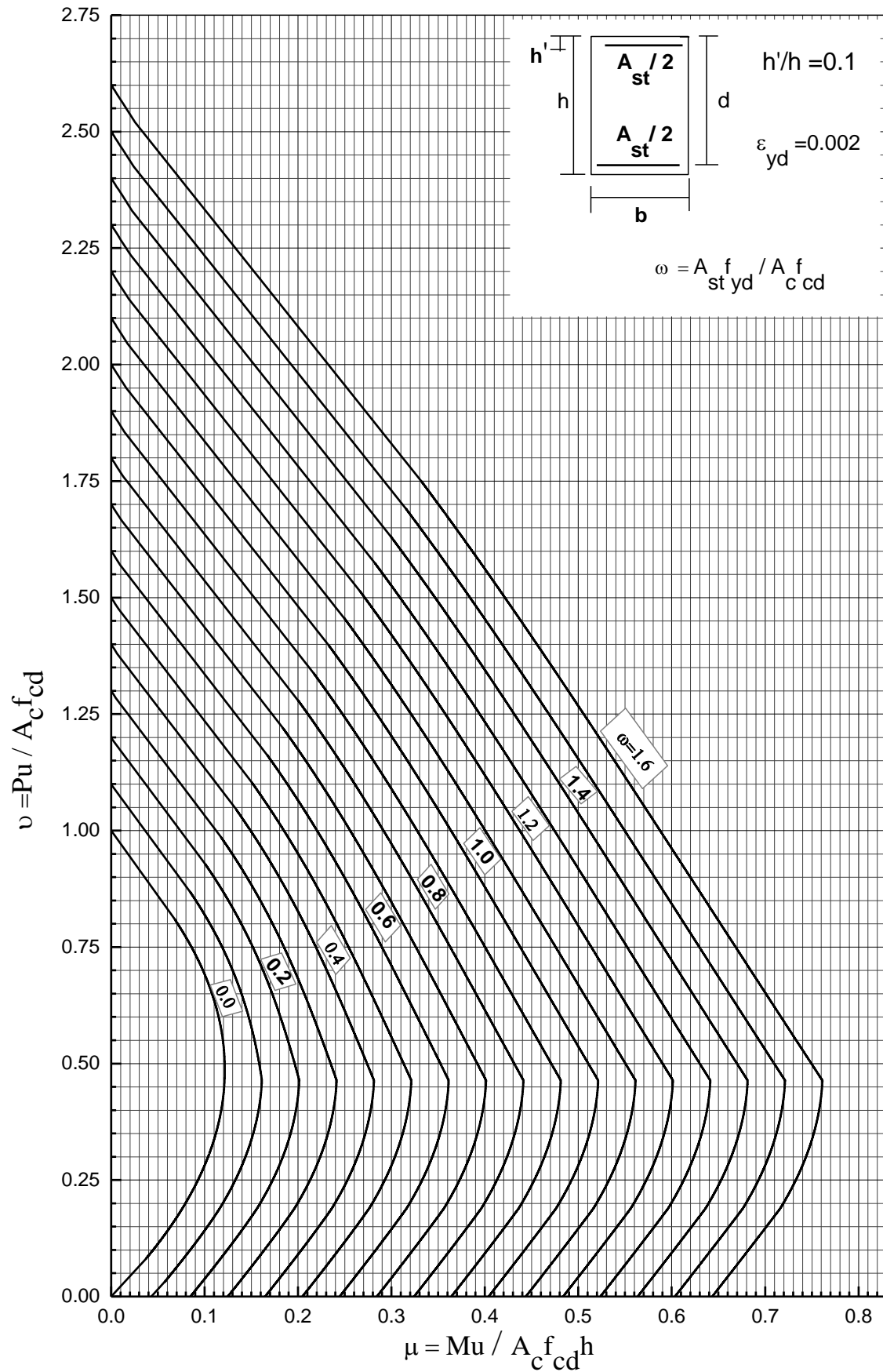

Figure 4.1 Uniaxial design chart for unconfined reinforced concrete column

4.2. Discussion

The amount of strength enhancement is a function of the transverse reinforcement configuration, size, spacing, yield strength, longitudinal reinforcement distribution, concrete strength and column cross section. These variables are considered in determining the confinement pressure. A uniaxial interaction curves are developed for both confined and unconfined concrete for comparison. The interaction curves for confined concrete are drawn for different confinement pressures. The axial load – bending moment capacities are expressed in non-dimensional form to use for different section sizes and material properties and they are computed by varying the neutral axis depth and the points to draw the diagram are generated using C++ programming language. Comparison between the confined and unconfined load-moment interaction diagrams of concrete columns are presented for different column configurations. The lateral pressure is considered in terms of the mechanical ratio of lateral reinforcement.

$$\gamma = \frac{A_p f_{yd}}{S B f_{cd}}$$

Where, A_p is the area of lateral reinforcement used, S is pitch of spiral or spacing of ties, B is diameter or width of column.

f_{yd} and f_{cd} are design strengths of the lateral reinforcement and the concrete to be used.

4.2.1. Rectangular columns

The interaction diagrams to the four selected rectangular column lateral reinforcement configurations which usually used for uniaxial bending with varying confinement pressure ($\gamma = 3.5\%$, 5% , 7% , 10% , 13% and 16%) and for the unconfined column are shown in Figures 4.2 to 4.7.

Figure 4.2 shows interaction curves for a rectangular column confined by perimeter type ties with different lateral reinforcement ratio, γ . The minimum mechanical ratio of lateral reinforcement used for this type of configuration is 5% , since lesser values of γ are not enough to enhance the column strength beyond the confinement required to compensate the loss of cover concrete. Due to confinement effect the axial load- bending interaction curve shows considerable enlargement within the compression failure zone (above the balanced point). The capacity of the column increases by 1.6% , 8.3% , 14.97% , 23% and 28% for mechanical ratio of lateral reinforcement of 5% , 7.5% , 10% , 13% and 16% respectively.

Uniaxial Interaction Chart of Reinforced Concrete Column Confined
by Transverse Reinforcement

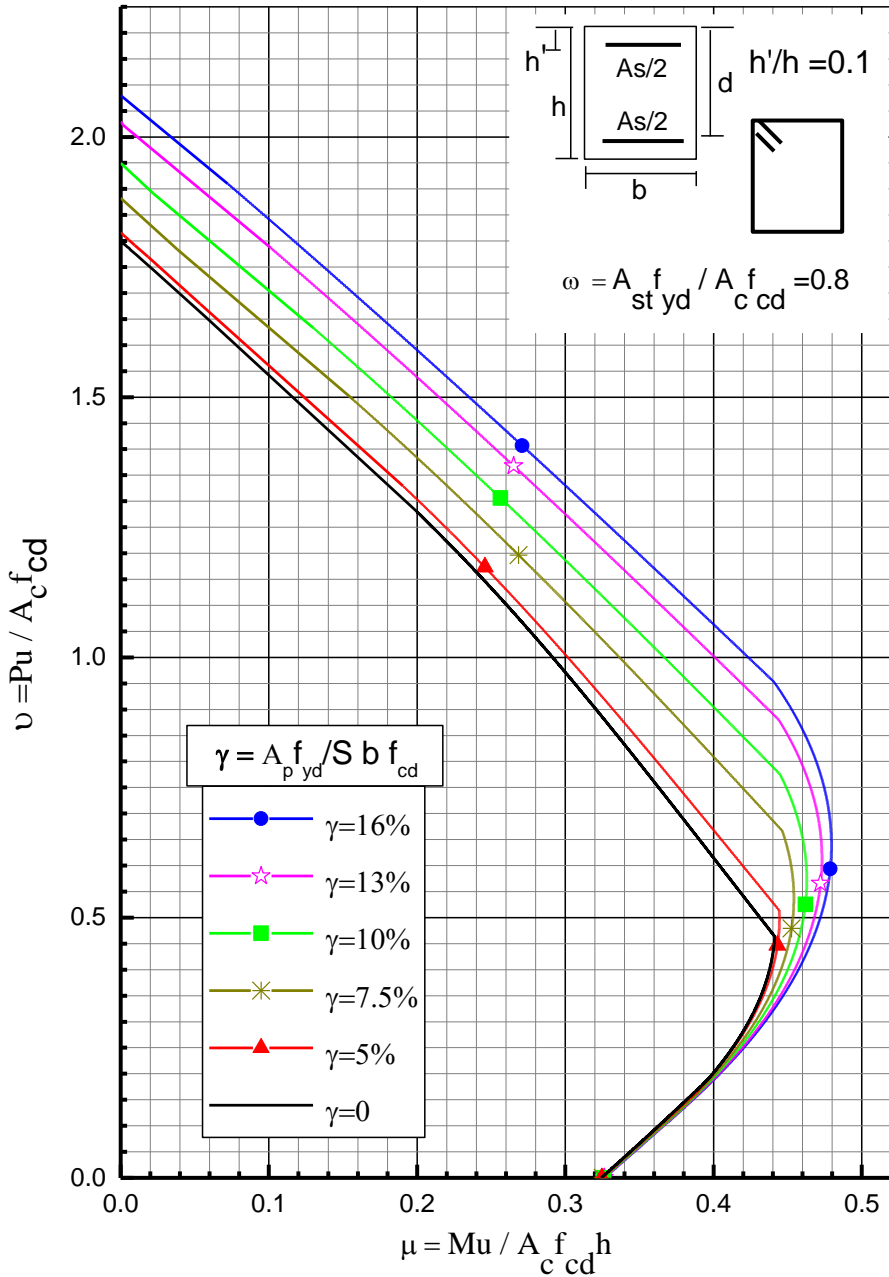

Figure 4.2 Interaction diagram for rectangular column with perimeter type tie ($h'/h=0.1$)

As shown in the figure the increments in the capacity of the column are linear with the amount of the lateral reinforcement used and it is almost equal within the compression zone, but confinement has little effect on the tension controlled region, the interaction curves coincide for different lateral pressures and its effect increases as the neutral axis depth increases from the pure bending to the balanced point.

Uniaxial Interaction Chart of Reinforced Concrete Column Confined by Transverse Reinforcement

For columns with additional cross ties show a similar pattern with the perimeter type tie, but the increment in load moment capacity is larger as the number of cross ties increases as shown in Figure 4.3 and 4.4 and due to these additional cross ties the minimum amount of lateral reinforcement, γ required is 3.5%.

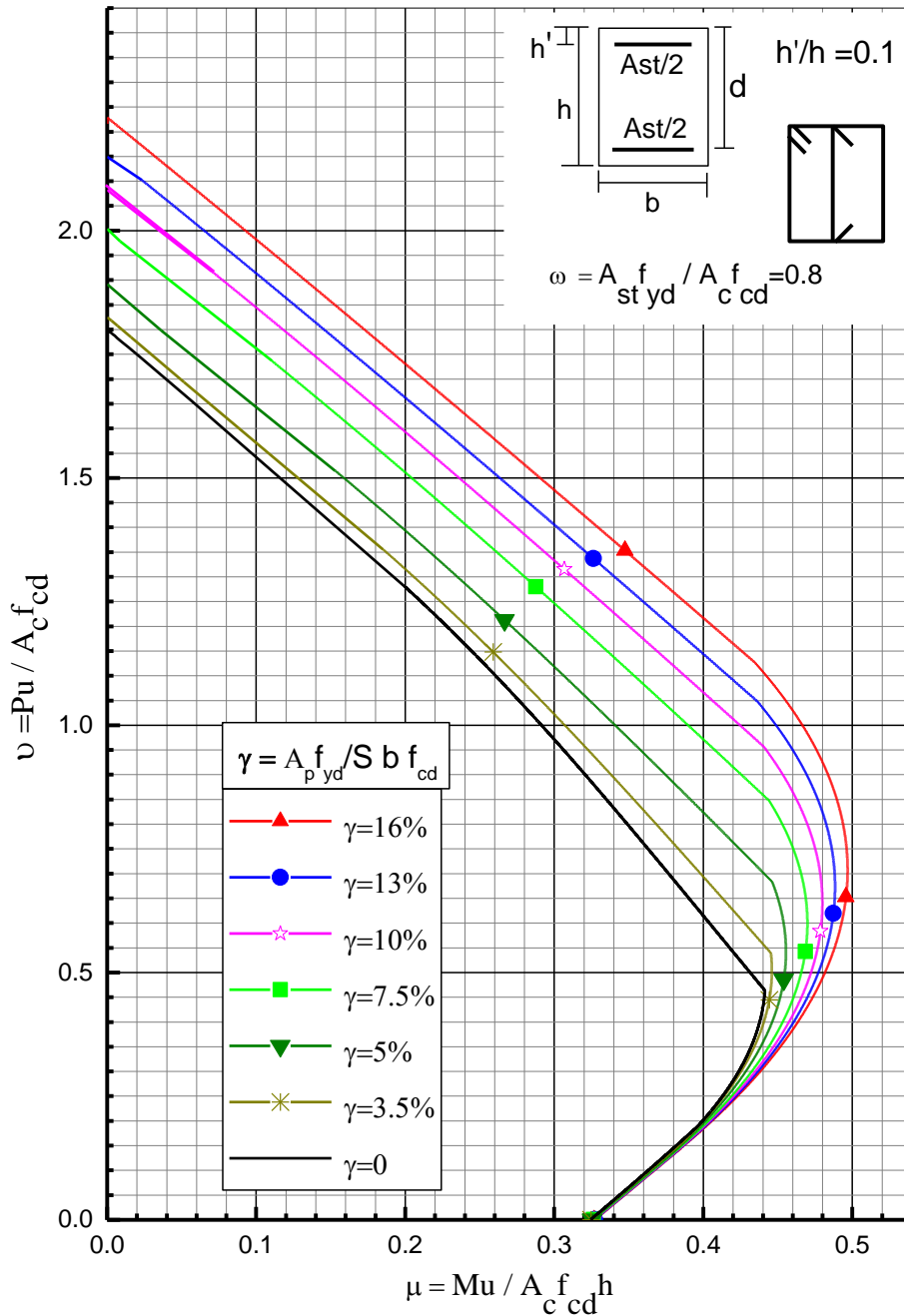

Figure 4.3 Interaction diagram for rectangular column with single cross tie

Uniaxial Interaction Chart of Reinforced Concrete Column Confined by Transverse Reinforcement

The capacity of the column within the compression controlled region increase by 2.5%, 9.2%, 20.4%, 29.25%, 35% and 41.64% for one additional cross tie and 6.33%, 15.37%, 27.7%, 35.25%, 44.2% and 53.32% with two additional cross ties for mechanical ratio of lateral reinforcement of 3.5%, 5%, 7.5%, 10%, 13% and 16% respectively.

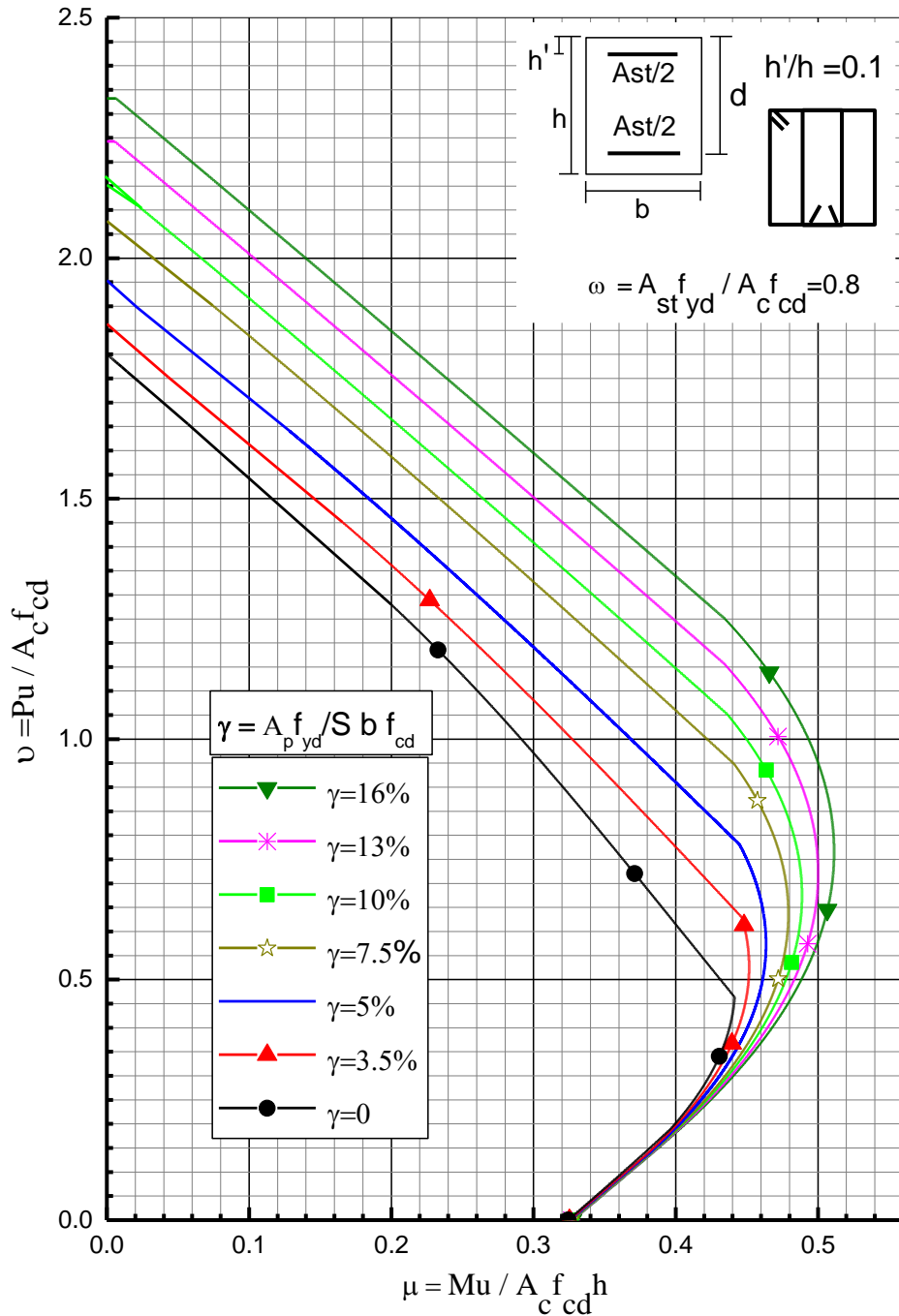

Figure 4.4 Interaction diagram for rectangular column with double cross tie

Uniaxial Interaction Chart of Reinforced Concrete Column Confined by Transverse Reinforcement

The rate of confinement effect on column capacity within the compression controlled region decrease as the number of additional cross ties increased as shown in Figure 4.5 for lateral reinforcement ratio 7.5%. The capacity of a column increase by 8.3%, 20.3% and 27.7% for perimeter type tie, with one and two additional cross ties respectively relative to the unconfined column capacity.

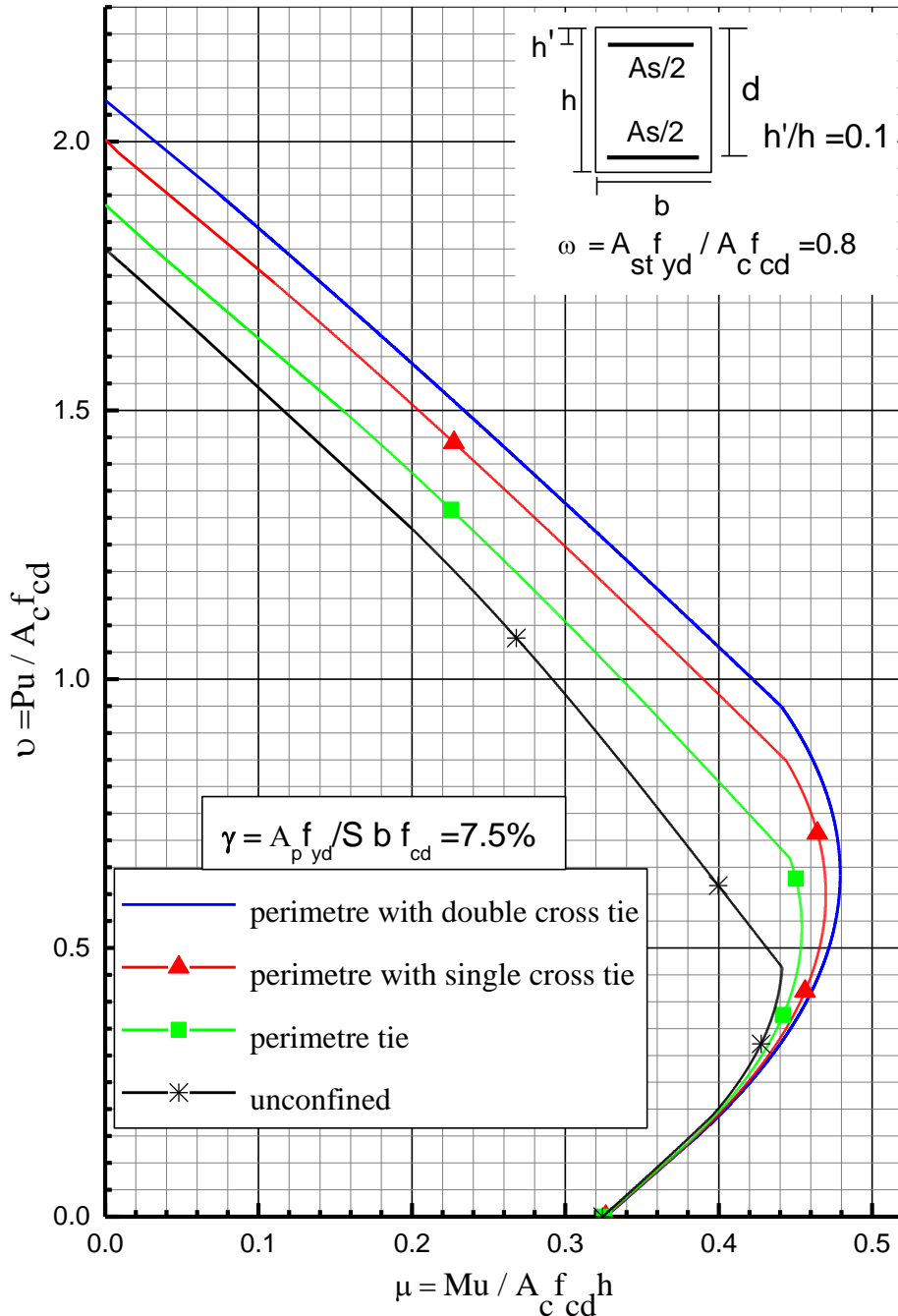

Figure 4.5 Interaction diagram for rectangular column with different tie configurations

Uniaxial Interaction Chart of Reinforced Concrete Column Confined
by Transverse Reinforcement

Interaction curves for a column with additional overlapping tie is shown in Figure 4.6 and shows a similar pattern of capacity enlargement within the compression controlled region as the other rectangular configurations with 6.1%, 16.35%, 29.24%, 37.79%, 48.07% and 58.34% load capacity increment for the lateral reinforcement ratios used.

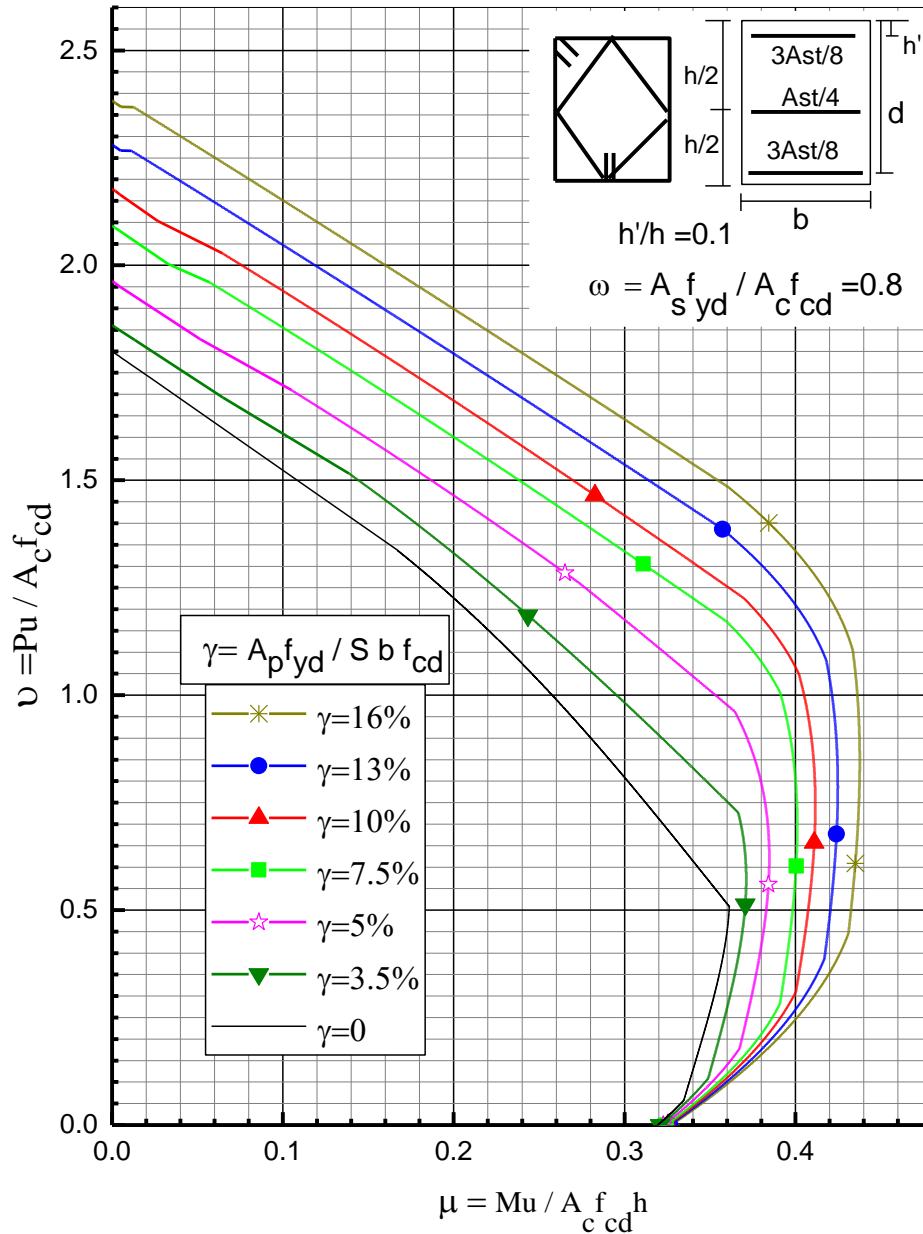

Figure 4.6 Interaction diagram for rectangular column with overlapping tie

But due to the presence of longitudinal reinforcements at mid section, confinement also has an effect on the tension controlled region. For this type of unconfined column configuration the longitudinal reinforcements which are located at mid section will not yield for small neutral axis depth (when the neutral axis is within the section), but due to confinement effect the concrete strain will increase leads to yielding of these intermediate longitudinal reinforcements even for

Uniaxial Interaction Chart of Reinforced Concrete Column Confined by Transverse Reinforcement

small neutral axis depth which gives a higher axial force -bending moment capacity as shown in Figure 4.6 between the pure bending and the balanced point and the enlargement in load-moment capacity of the column increases as the neutral axis depth.

The axial load- bending moment capacity gain due to confinement decreases as the concrete cover of the column increases. Columns with large concrete cover requires higher confinement to compensate the loss of capacity due to spall of concrete cover. Interaction curves for perimeter type tie with a cover ratio of 0.05 is shown in Figure 4.7. The column capacity increases by 8%, 15.7%, 23%, 28.37% and 32.74%, which are larger as compared to the capacity gain 1.6%, 8%, 15%, 23% and 28% for a column with a cover ratio of 0.1.

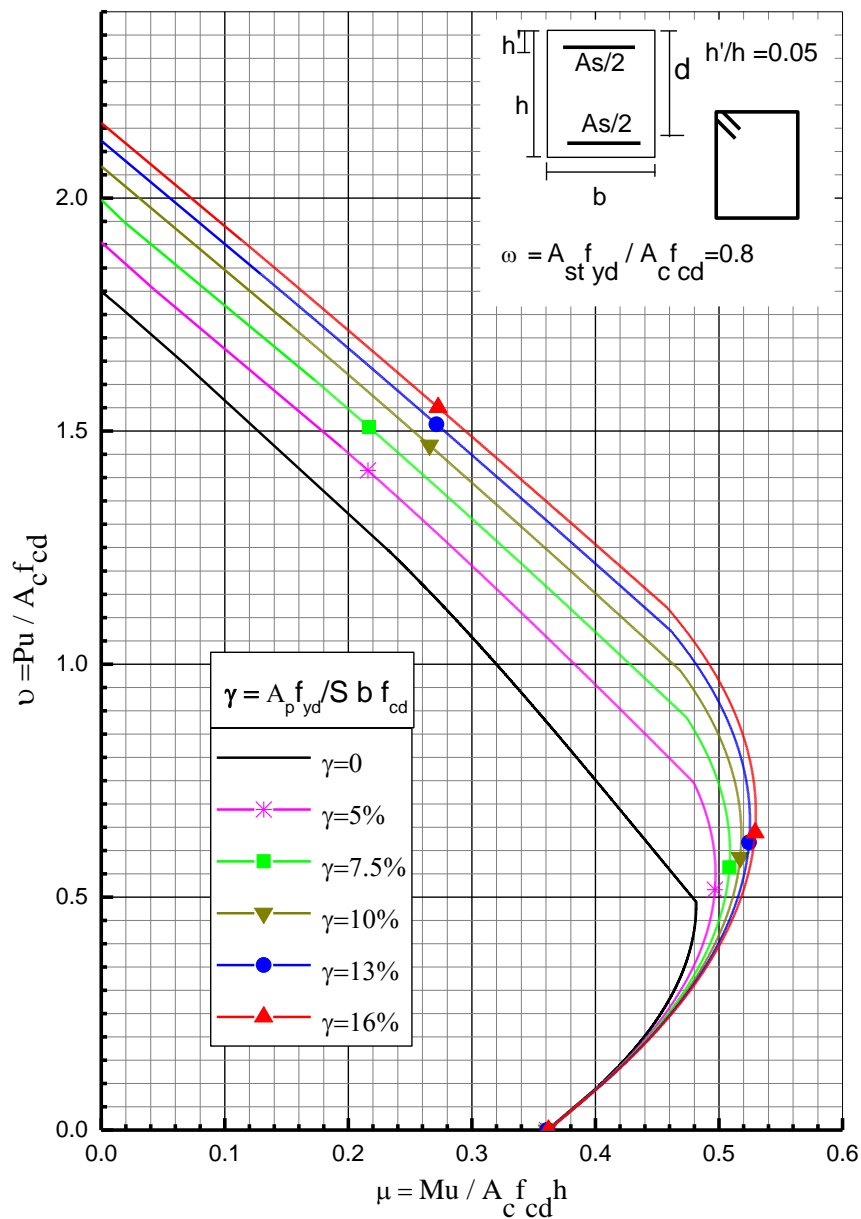

Figure 4.7 Interaction diagram for rectangular column with perimeter type tie ($h'/h=0.05$)

4.2.2. Circular columns

Axial force- bending moment interaction diagrams of circular RC columns with different amount of spiral and tie lateral reinforcements are shown in Figure 4.8, 4.9 and 4.10 to observe the effect of confinement.

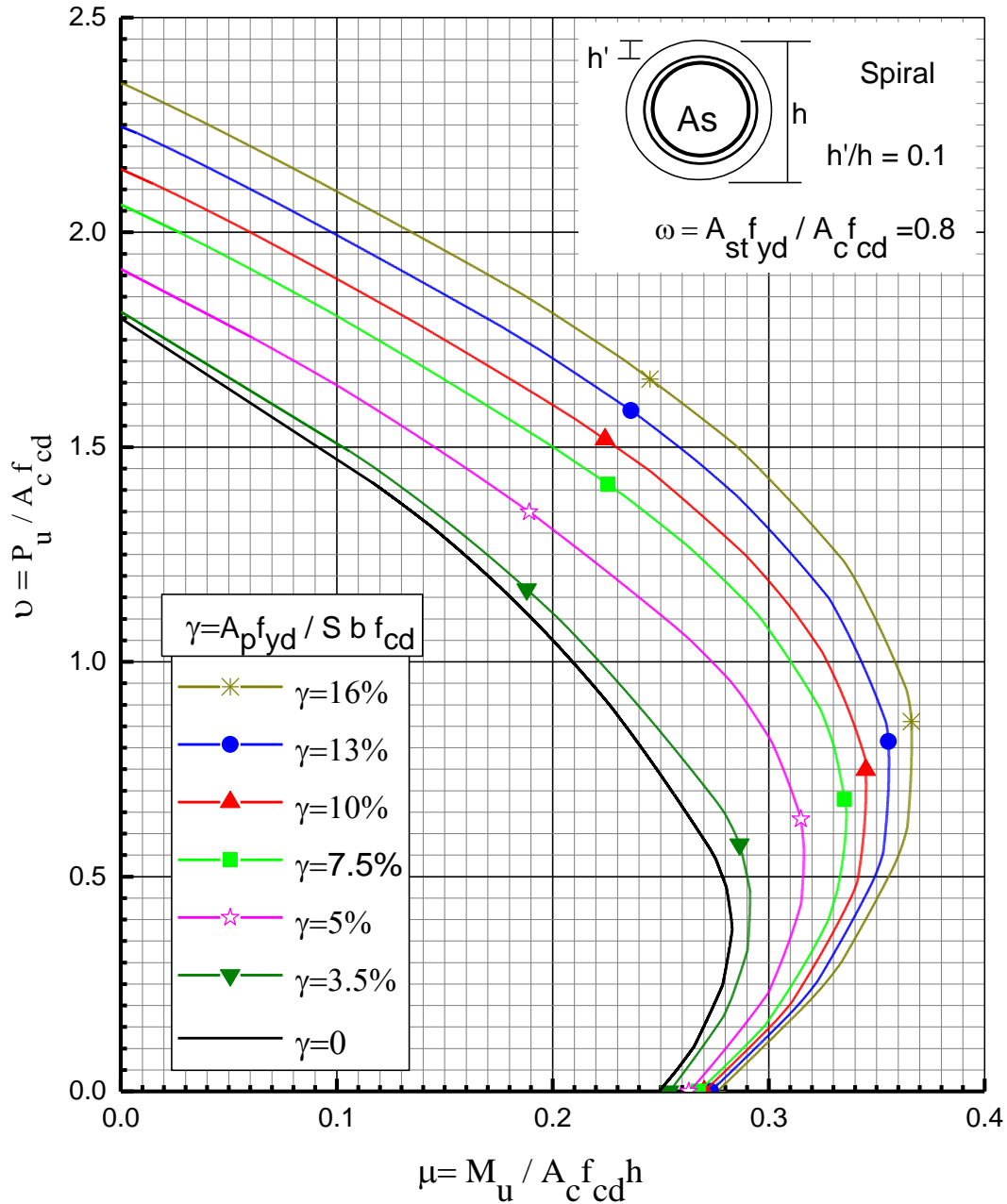

Figure 4.8 Interaction diagrams for RC circular spirals

The minimum lateral reinforcement ratio for circular columns is 3.5%. The column capacity increases as the amount of lateral reinforcement used. The capacity gain within the compression controlled region are 1.6%, 11.5%, 26.5%, 34.8%, 44.7% and 54.6% in circular

Uniaxial Interaction Chart of Reinforced Concrete Column Confined
by Transverse Reinforcement

spirals and 1.4%, 10.7%, 25.6%, 33.3%, 42.6% and 52% in circular hoops for lateral reinforcement ratios of 3.5%, 5%, 7.5%, 10%, 13% and 16% respectively.

In circular confined columns due to yielding of intermediate longitudinal reinforcements for small neutral axis depth, the column interaction diagrams also have increments in the tension controlled region. The capacity gain increases as the neutral axis depth increases from the pure bending to the balanced point.

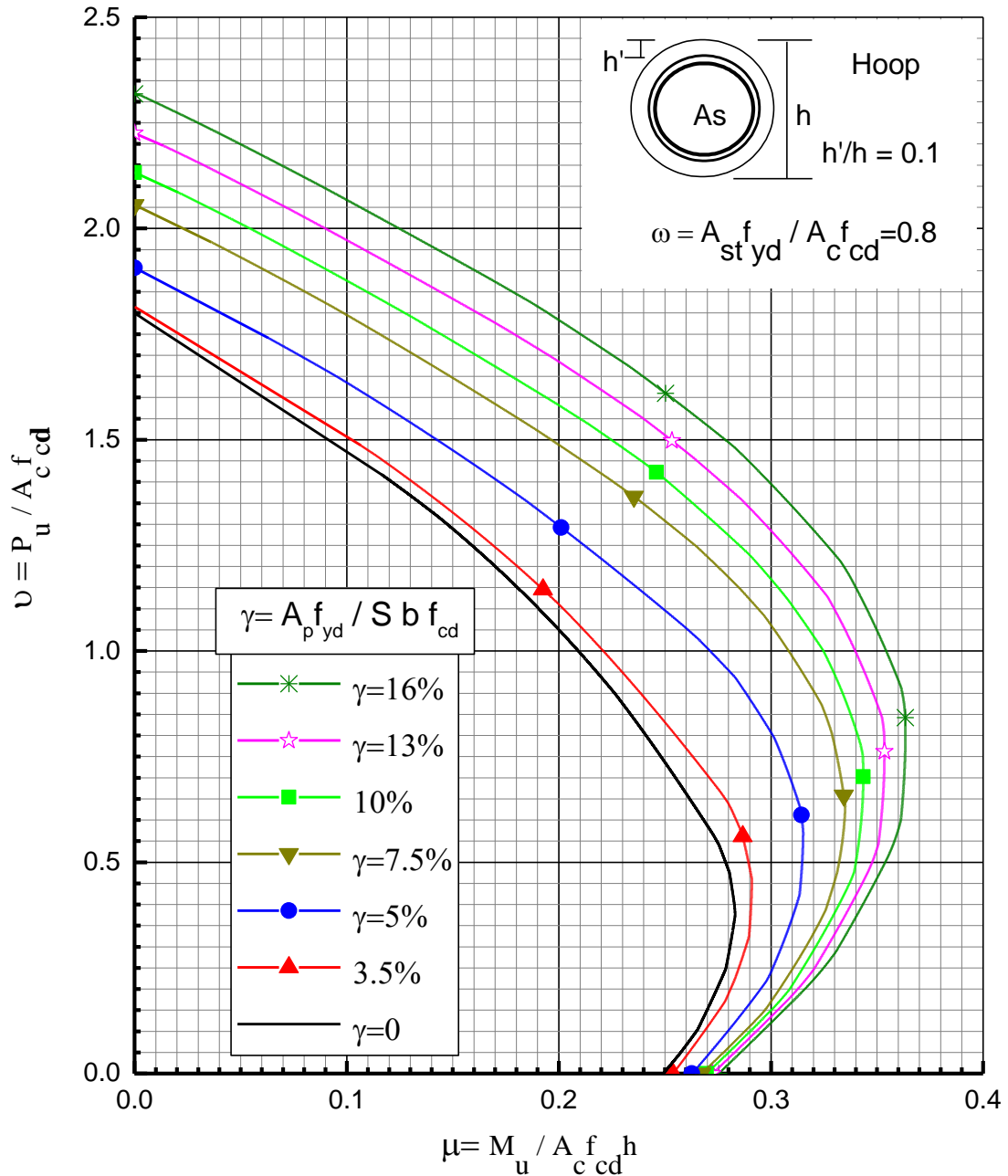

Figure 4.9 Interaction diagrams for RC circular hoops

Uniaxial Interaction Chart of Reinforced Concrete Column Confined
by Transverse Reinforcement

Spiral reinforcements are continues throughout the height of a column which gives uniform lateral pressure, whereas circular hoops are located at distinct levels of a column and the lateral pressure is smaller between the ties than at tie positions. Due to this reason spiral columns give higher confinement than circular hoops but the difference reduces as the confinement pressure increases and the effect is reflected in the column axial load -bending moment interaction curve as shown in Figure 4.10.

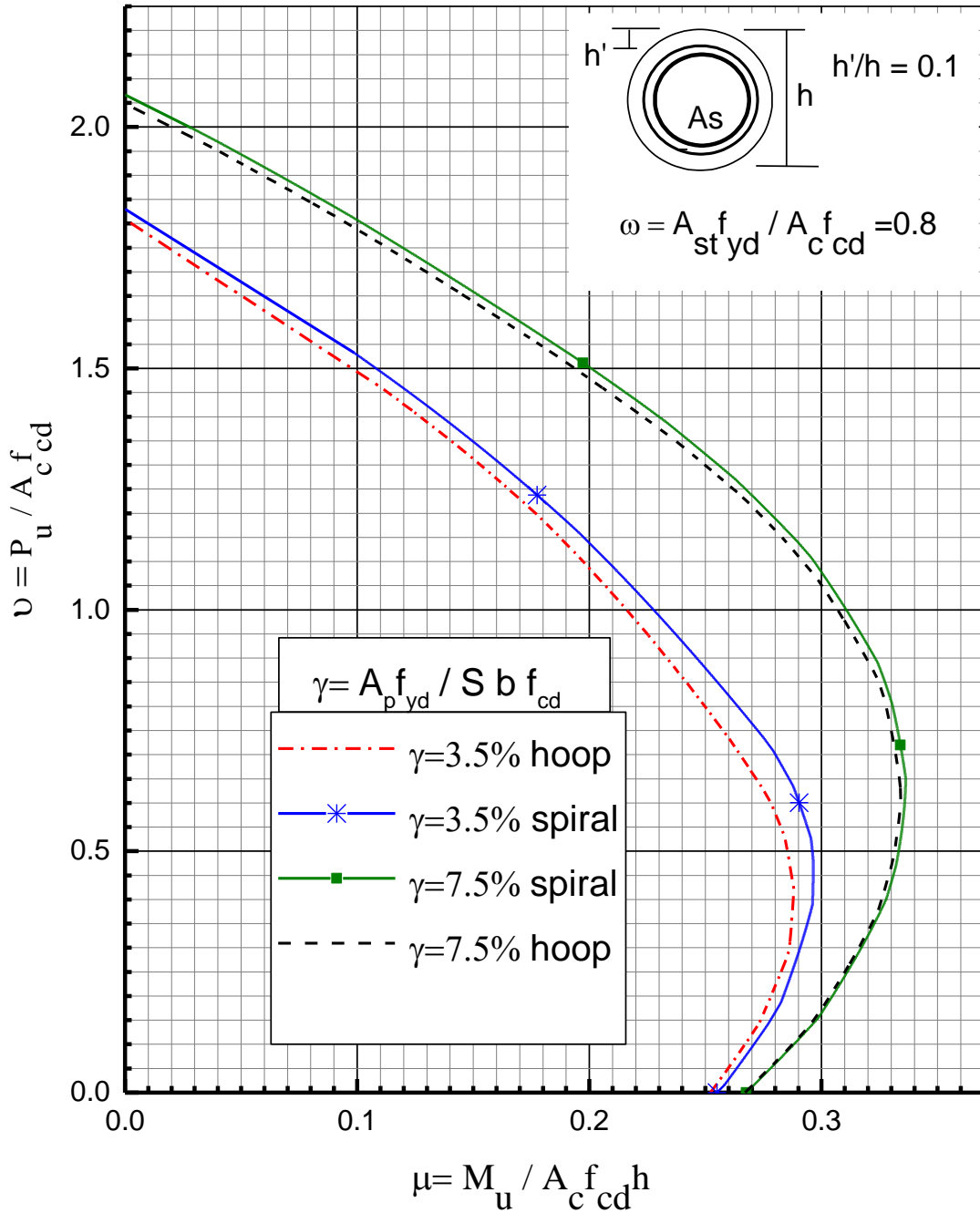

Figure 4.10 Interaction diagrams for RC circular columns

4.3. Numerical Example using the Confined Design Chart

Design a reinforced concrete circular short column, which spirally reinforced by 10mm diameter bar with a pitch of 80mm, subjected to design loads of $P= 2500$ kN and $M=250$ kNm. The material strengths are; C-30 and S-460.

Solution:

For C-30, $f_{cd}= 13.66$ MPa and for S-460, $f_{yd} = 400$ Mpa

Using a column size of 500 mm diameter with $h'/h=0.1$, the non-dimensional axial force and bending moments are:

$$\nu = \frac{P}{A_c f_{cd}} = \frac{2500 \cdot 1000}{\frac{\pi \cdot 500^2 \cdot 13.6}{4}} = 0.936$$

$$\mu = \frac{M}{A_c h f_{cd}} = \frac{250 \cdot 10^6}{\frac{\pi \cdot 500^2 \cdot 500 \cdot 13.6}{4}} = 0.187$$

i) Design as unconfined concrete

Using uniaxial chart No 12 the mechanical reinforcement ratio is;

$$\omega = 0.65$$

$$A_s = 0.65 * \frac{\frac{\pi \cdot 500^2 \cdot 13.6}{4}}{400} = 4339 \text{ mm}^2$$

ii) Design as confined concrete

$$\gamma = \frac{A_p f_{yd}}{H S f_{cd}} \quad \text{Where, } A_p = \text{area of lateral reinforcement used} = \frac{\pi \cdot 10^2}{4} = 78.54 \text{ mm}^2,$$

$S =$ pitch of spiral = 80mm , $H =$ column diameter = 500mm

$$\gamma = \frac{78.5 \cdot 400}{500 \cdot 80 \cdot 13.6} * 100 = 5.775\%$$

Using the design chart shown in Figure 4.11 the mechanical reinforcement ratio is

$$\omega = 0.398$$

$$A_s = 0.398 * \frac{\frac{\pi \cdot 500^2 \cdot 13.6}{4}}{400} = 2657 \text{ mm}^2$$

Uniaxial Interaction Chart of Reinforced Concrete Column Confined
by Transverse Reinforcement

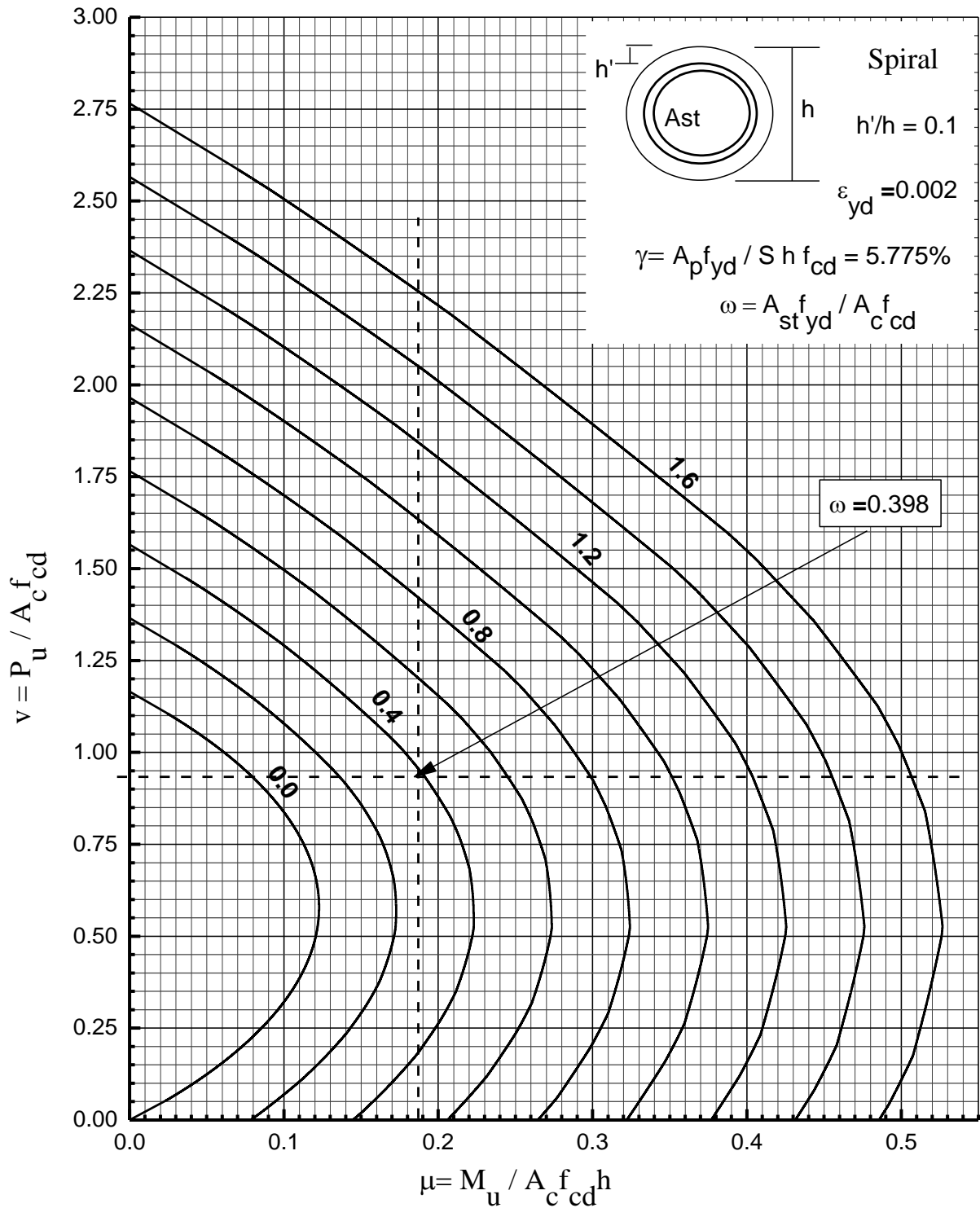

Figure 4.11 Uniaxial interaction diagram of RC circular spiral column with $\gamma = 5.775\%$

CHAPTER FIVE

CONCLUSION AND RECOMMENDATION

5.1. Conclusion

The effect of confinement on axial force- bending moment interaction of reinforced concrete column was investigated in this study. Six transverse steel configurations such as hoop and spiral for circular column and perimeter type tie, single cross tie, double cross tie and overlapping tie for rectangular column are selected which usually used for uniaxial bending. The stress-strain model given in Euro code-2 for confined concrete is used in which the strength enhancement factor, the concrete strain at maximum stress and the concrete ultimate strain are calculated for different lateral pressure values.

The non-dimensional axial force- bending moment capacities used to draw the interaction curves were calculated using equilibrium of internal forces at ultimate limit state for different neutral axis depths and the points are generated using C++ programming language. The interaction diagrams are drawn for the selected column configurations with different lateral pressures. Based on the observations from the interaction diagrams the following conclusions are made.

- Confinement increases the strength and ductility of the concrete, which results a considerable enlargement of axial force –bending moment capacity in the compression controlled region of RC column, but the curve almost coincide with the unconfined concrete interaction diagram within the tension controlled region.
- RC columns laterally reinforced with additional cross ties have higher axial force-bending moment capacity, which is due to cross ties increase the effective confined area of the concrete. The load carrying capacity of a column increases as the number of cross ties. The column capacity increases by 8.3%, 20.3% and 27.7% for perimeter type tie, with one and two additional cross ties respectively for transverse ratio of 7.5%.
- Circular RC column sections are more effective in confinement than rectangular sections. The capacity of the column increases by 1.6%, 8.3%, 14.97%, 23% and 28% in rectangular perimeter type tie whereas in circular hoops the capacity increases 10.7%, 25.6%, 33.3%, 42.6% and 52% for transverse reinforcement ratios of 5%, 7.5%, 10%, 13% and 16% respectively.
- Confinement is more effective in spiral columns than hoops, consequently spiral reinforced concrete column gives larger axial force-bending moment capacity than tie column but the difference reduces as the amount of transverse reinforcement increases.

- Due to the enlargement of the interaction curves, the uniaxial design charts prepared in this work considering confinement effect gives lesser amount of longitudinal reinforcement than the existing column design charts which were prepared based on unconfined stress -strain model.

5.2. Recommendation

Based on the results of this work and the conclusions, the following recommendations are made.

- Transverse reinforcements have additional advantage in terms of load carrying capacity of RC column. Even though the existing column design charts ignore the effect of confinement, with the capacity gain the confined interaction charts give a reasonable and economical column cross section and longitudinal reinforcement, which should be applicable instead of the charts which prepared based on unconfined stress block.
- Circular column is recommended instead of rectangular column; since confinement is more effective in circular sections with other variables are fixed, which increases the loading capacity of the column.
- The column reinforcements must be anchored according to the design specification to obtain the required confinement pressure from the transverse reinforcements and a proper supervision is required when the column reinforcements are erected.
- This study is restricted only for the uniaxial interaction chart of normal strength concrete column. Nowadays the use of high strength concrete is increased but the load response and failure pattern of NSC and HSC are different, that NSC is more ductile than HSC. High strength concrete shows less lateral expansion than the normal-strength concrete. Therefore, it is impossible to generalize the results of NSC for HSC, further investigation of confinement effects on high strength concrete is needed.
- Interaction diagrams for those selected configurations, which usually used for uniaxial bending are prepared, but transverse reinforcements can be provided in several other configurations; therefore this work can be extended with other configurations for biaxial bending.

REFERENCES

1. Ahmed S H and Shah H P. Stress-stain curves of concrete confined by spiral reinforcement ACI Journal. 1982; 79(6): 484-490.
2. American Concrete Institute. ACI 318:2008, Building Code Requirements for Structural Concrete. Michigan: Farmington Hills; 2008.
3. Assa B, Nishiyama M and Watanabe F. New approach for modeling confined concrete I: Circular columns. J structural engineering. 2001;127(7):743-750.
4. Assa B, Nishiyama M and Watanabe F. New approach for modeling confined concrete II: Rectangular columns. J structural engineering. 2001;127(7):751-757.
5. Bhowmick R., Sharma U. and Bhargava P. Numerical Simulation of Confined Concrete Columns and a Parametric Study. Asian Journal of Civil Engineering.2006: 7(3): 269-289.
6. Bouafia Y, Idir A, Kachi M S and Dumontet H. Stress- Strain Relation for the Confined Concrete. ACMA. 2010; pp 19-21.
7. Chung H S, Yang K H, Lee Y H and Eun H C. Strength and Ductility of Laterally Confined Concrete. NRC Research Press. 2002.
8. Claeson C. Finite element analysis of confined concrete columns. Sweden; Chalmers University of Technology; 2010.
9. Desayi P, Iyengar K T S and Reddy T S. Equation for stress strain curve of concrete confined in circular steel spiral. Materials and structures. 1978; 11(65): 339-345.
10. Durga M P and Rama S D. Effect of Confinement on Load- Moment Interaction Behavior of Reinforced concrete Column. International Journal of Emerging Technology and Advanced Engineering. 2013; 3(5).
11. El-Dash K M and Ahmed S H. A model for stress-strain relationship of spirally reinforced normal and high strength concrete. Magazine of concrete research. 1995; 45(171):177-184.
12. European Committee for Standardization. Design of concrete structures: General rules and rules for buildings (Eurocode 2). CEN; 2002.
13. Faftis A and Shah S P. Cyclic Stress- Strain Behavior of Concrete Confined with Spirals. ACI Journal Proceedings. 1985; 82(3): 423-433.
14. Girma Zerayohannes .Ethiopian Building Code Standard Two Part 2: Design aids for Reinforced Concrete Sections on the bases of EBCS 2. Ministry of Works and Urban development, Addis Ababa; 1995.
15. Giuseppe C and Marinilla F. Compressive Behaviour of Concrete Elliptical Columns Confined by Single Hoops. Journal of Engineering Structures.2007; 7(2): 408-417.

16. Kent D C, and Park R. Flexural Members with Confined Concrete. *Journal of the Structural Division, Proceedings of the ASCE*. 1971; 97(ST7).
17. Khaleek A, Yadev R K and Rajeev C. Effect of Lateral Confinement on strength of Concrete. *ISCA Journal of Engineering Science*. 2012;1(1): 40-44.
18. Mander J B, Prestly M J N, and Park R. Theoretical stress-strain model for confined concrete. *Journal of Civil Engineering, ASCE*. 1994; 9(3): 1804-1825.
19. Melat Ayele. Experimental and analytical investigation on confined reinforced concrete column. MSc. thesis, Addis Ababa University. 2010.
20. Mendist P A, Kovacic D, and Setunge S. Basis of the Design of Lateral Reinforcement for high strength concrete columns. *Journal of Structural Engineering and Mechanics*. 2002; 9(6): 589-600.
21. Ministry of Urban Development, Housing and Construction. Ethiopian Building Code Standard- Based on European Norm, Design of Concrete Structures, EBCS-2. 2014.
22. Ministry of Works and Urban Development. Ethiopian Building Code Standard, Structural Use of Concrete, EBCS-2.1995.
23. Mohammed A H, Abdel-Halim and Tahir M Abdu Lebdeh. Analytical Study for Concrete Confinement in Tied Columns. *Journal of Structural Engineering, ASCE*. 1989; 115(11).
24. Moehle J P and Cavanagh T. Confinement effectiveness of cross ties in RC. *ASCE*. 1995;111(10):2105-2120.
25. Narayan K S, Gowda H C, Venkataramana K and Yaragal S C. Enhancement of Carrying Capacity and Ductility of R.C. Columns with Welded Wire Fabrics as Lateral Reinforcements for Potential Application in Seismic Zones and Under Fire Load-An Experimental Investigation. *IJESE*. 2009; 2(2): 154-159.
26. Pallewatta T.M, Irawan P and Meakawa K. Effectiveness of laterally arranged reinforcement on the confinement of core concrete. *J materials, Conc. Struct*. 1995; 28(520): 297-308.
27. Pamuda P, Tavio T and Suprobo P. Analytical confining model of square reinforced concrete columns using external steel collars. *International Journal of ICT aided Architecture and Civil Engineering*. 2014; 1(1): 1-18.
28. Paultre P and Légeron F. Confinement reinforcement design for reinforced concrete columns, *Journal of Structural Engineering, ASCE*. 2008; 134(5): 738-749.
29. Reisi M, Mostofinejad D and Azizi N. M-P Curves for Strengthened Concrete Columns with Active Confinement. *The 14th World Conference on Earthquake Engineering, Beijing*. 2008.

30. Riad Benzaid and Habib-Abdelhak Mesbah. Circular and Square Concrete Columns Externally Confined by CFRP Composite: Experimental Investigation and Effective Strength Models. Available from: <http://dx.doi.org/>.
31. Richart F E, Brandtzaeg A and Brown R L. The failure of plain and spirally reinforced concrete in compression. Engineering experiment station, University of Illinois.1929: Bulletin No. 190.
32. Riyad Zeidan. Experimental and Analytical Investigation to study the Role of Confinement, MSc. Thesis. Addis Ababa University. 2005.
33. Saatcioglu M. and Razvi S R. Strength and ductility of confined concrete. Journal of structural engineering. 1992;118(25):1590-1607.
34. Sakai K and Shamim S A. What do we know about confinement in reinforced concrete columns. ACI Structural Journal. 1989; 86(2): 192-207.
35. Shafkat A. and Ali A. Lateral Confinement of RC Short Columns. Sci. Int. (Lahore).2012; 24(4): 371-379.
36. Shiekh S A and Tocluku M T. Reinforced concrete columns confined by circular spirals and hoops. ACI structural Journal. 1993; 90(5): 542-553.
37. Sheikh S A and Uzumeri S M. Analytical Model for Concrete Confinement in Tied Columns. Journal of the Structural Engineering, ASCE. 1982; 108(ST12).
38. Shiekh S A and Yeh C C . Analytical Moment Curvature Relations for Tied Concrete columns. Journal of Civil Engineering, ASCE. 1982; 118(2).
39. Subramanian H. Design of Confinement Reinforcement for RC Columns. The Indian Concrete Journal. 2001.
40. Tavio T, Winbadi I, Kusuma N A and Tirtajaya R. Effects of Confinement on Interaction Diagrams of Square Reinforced Concrete Columns. Civil Engineering Dimension.2009; 11(2): 78-88.
41. Tomas T C Hsu and Mo Y L. Unified theory of concrete structures. United Kingdom: John Wiley and sons, Ltd publisher; 2010.
42. Watson S, Zahn F A and Park R. Confining Reinforcement for Concrete Columns. Journal of Structural Engineering, ASCE. 1994; 120(6): 1798-1824.
43. Wight J K and MacGregor J G. Reinforced Concrete Mechanics and Design. 6th edition. New Jersey: Pearson; 2012.
44. Yoon Y S, Shin H O, Lee S H and Hwang D J. Assessing Transverse Reinforcement For Enhanced Performance Of 200mpa Ultra-High-Strength Concrete Columns. Hokkaido University Collection of Scholarly and Academic Papers, Korea. 2012.

APPENDICES

Appendix A: C++ Program for Rectangular Confined RC Column

```
#include<iostream>
#include<fstream>
#include<math.h>
using namespace std;
int main()
{
    float ecm, ec2, es1, es2, x, xn, hn, kc, fyd, fcd, fs1, fs2, w, m1, m2;
    float ac, Bc, v, m ; // hn=h'/h, xn=x/h, m1=fs1/fyd, m2=fs2/fyd
    hn=0.1; w=0.8; // hn=h'/h
    kc=1.25; //strength enhancement factor
    ec2=2.8;
    int Es=200000; int eyd=2;
    int N1=20000; int N2=1000;
    cout<<"Interaction diagram of uniaxial concrete column\n"; // v = P/fcd Ac, m= M/ fcd Ac h
    ofstream myfile;
    myfile.open("M-P interaction.text");
    fyd=eyd*Es;
    for (int i=1; i<=N1;i++)
    {
        xn=1.4*hn+i*(1-1.4*hn)/N1;
        ecm=4.6;
        ac=((3*ecm-ec2)*xn)/((1-hn)*3*ecm);
        Bc=((ecm*(6*ecm-4*ec2)+ec2*ec2)*xn)/((1-hn)*4*ecm*(3*ecm-ec2));
        es1=ecm*((1-hn)-xn)/xn;
        es2=ecm*(xn-hn)/xn;
        if (es1<eyd)
            { fs1=es1*Es; }
        else { fs1=eyd*Es;}
        if ( es2<eyd )
            { fs2=es2*Es; }
        else { fs2=eyd*Es;}
    }
}
```

Uniaxial Interaction Chart of Reinforced Concrete Column Confined by Transverse Reinforcement

```

        m1= fs1/fyd;  m2= fs2/fyd;
        v= kc*(1-hn)*ac+ m2*w/2 - m1*w/2;
        m= kc*(1-hn)*ac*(0.5-((1-hn)*Bc)) + 0.5*m2*w*(0.5-hn) + 0.5*m1*w*(0.5-hn);
        myfile<<m<<"\t"; myfile<<v<<"\n";
    }
for (int i=1; i<=N2;i++)
{
    xn=2*i;
    ecm=ec2*xn/(xn-0.4285714285714);
    ac=(125+128*ecm/ec2-(64*ecm*ecm/(ec2*ec2)))/(189*(1-hn));
    Bc=(0.5-(40*(2*ecm-2*ec2)*(2*ecm-2*ec2))/(7*(125*ec2*ec2+128*ecm*ec2-64*ecm*ecm)))/(1-hn);
    es1=ecm*((1-hn)-xn)/xn;
    es2=ecm*(xn-hn)/xn;
    if (es1<eyd)
        { fs1=es1*Es;}
    else { fs1=eyd*Es;}
    if ( es2<eyd)
        { fs2=es2*Es;}
    else { fs2=eyd*Es;}
    m1= fs1/fyd;  m2= fs2/fyd;
    v= kc*(1-hn)*ac+m2*w/2 - m1*w/2;
    m= kc*(1-hn)*ac*(0.5-((1-hn)*Bc)) + 0.5*m2*w*(0.5-hn) + 0.5*m1*w*(0.5-hn);
    myfile<<m<<"\t"; myfile<<v<<"\n";
}
v= w+kc;    m= 0;
myfile<<m<<"\t"; myfile<<v<<"\n";
myfile.close();
return 0;
}

```

Uniaxial Interaction Chart of Reinforced Concrete Column Confined
by Transverse Reinforcement

Appendix B: Unconfined Uniaxial Design Chart Given in EBCS-2, Part-2, 1995

Uniaxial Chart No. 2

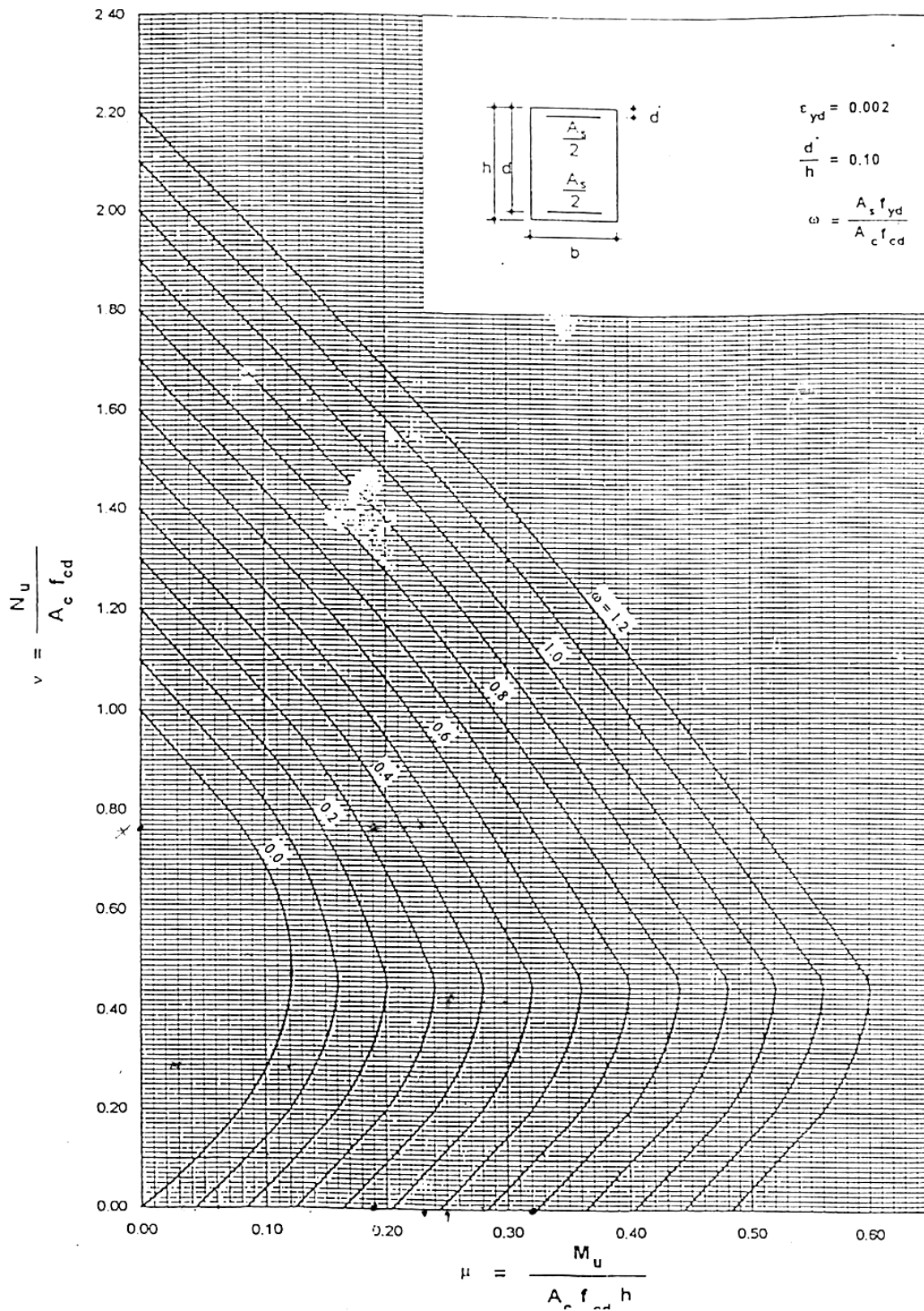

Appendix C: User's Guideline for Uniaxial Design Chart of Confined RC Column

Use the following procedures to design reinforced concrete columns

1. Calculate the design axial force, P_u and bending moment, M_u
2. Select the material strengths (concrete grade, longitudinal and transverse steel grade) to be used and calculate the design strengths.

$$f_{cd} = 0.85 \frac{f_{ck}}{\gamma_c} \quad \text{and} \quad f_{yd} = \frac{f_{yk}}{\gamma_y}$$

3. Select the column cross section, depth and width for rectangular column and diameter for circular column and the concrete cover ratio, h'/h .
4. Choose the type and calculate the amount of transverse reinforcement required (determine area, A_p and spacing, S)
5. Calculate the non-dimensional axial force, ν and bending moment, μ

$$\nu = \frac{P_u}{f_{cd} A_c} \quad \text{and} \quad \mu = \frac{M_u}{f_{cd} A_c h}$$

6. Calculate the mechanical ratio of lateral reinforcement.

$$\gamma = \frac{A_p f_{yd}}{S B f_{cd}}$$

Where, A_p is the area of lateral reinforcement used, S is pitch of spiral or spacing of ties and B is diameter or width of column.

f_{yd} and f_{cd} are design strengths of the lateral reinforcement and the concrete to be used respectively.

7. Based on the mechanical ratio of lateral reinforcement, the non-dimensional axial force and bending moments and the cover ratio read the mechanical reinforcement ratio, ω for the selected section configuration and calculate the total longitudinal reinforcement required.

$$A_{st} = \omega \frac{f_{cd} A_c}{f_{yd}}$$

Use linear interpolation for intermediate values of mechanical ratio of lateral reinforcement, γ

Note: To obtain the required confinement effect, the transverse reinforcements should be provided based on code requirements. For ductility class of medium the transverse reinforcements have to be 135° hooks and extensions of length 10 times of the reinforcement diameter used.

Appendix D: Uniaxial Design Chart of Confined RC Rectangular Column
Uniaxial Chart R1

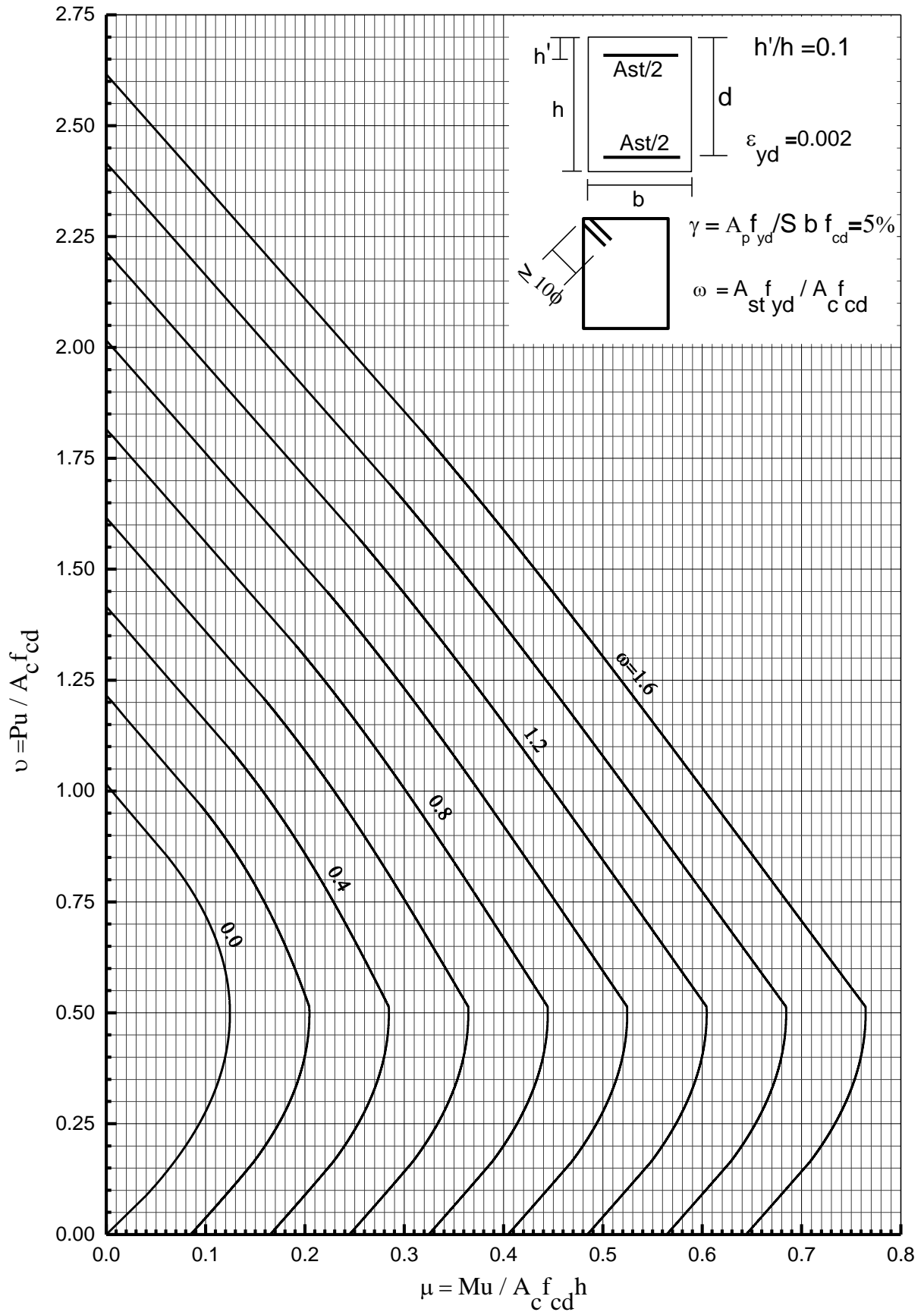

Uniaxial Interaction Chart of Reinforced Concrete Column Confined
by Transverse Reinforcement

Uniaxial Chart R2

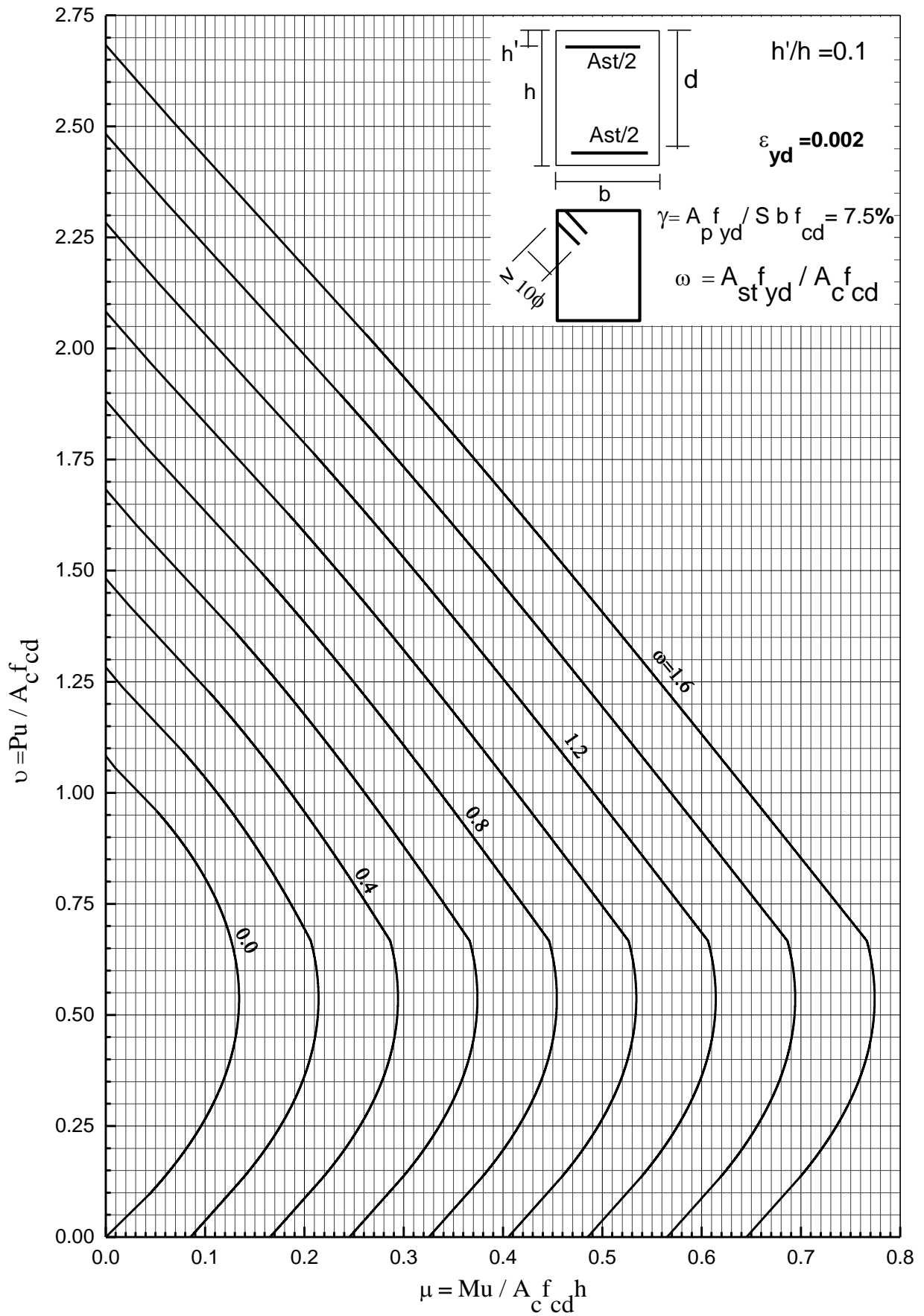

Uniaxial Interaction Chart of Reinforced Concrete Column Confined
by Transverse Reinforcement

Uniaxial Chart R3

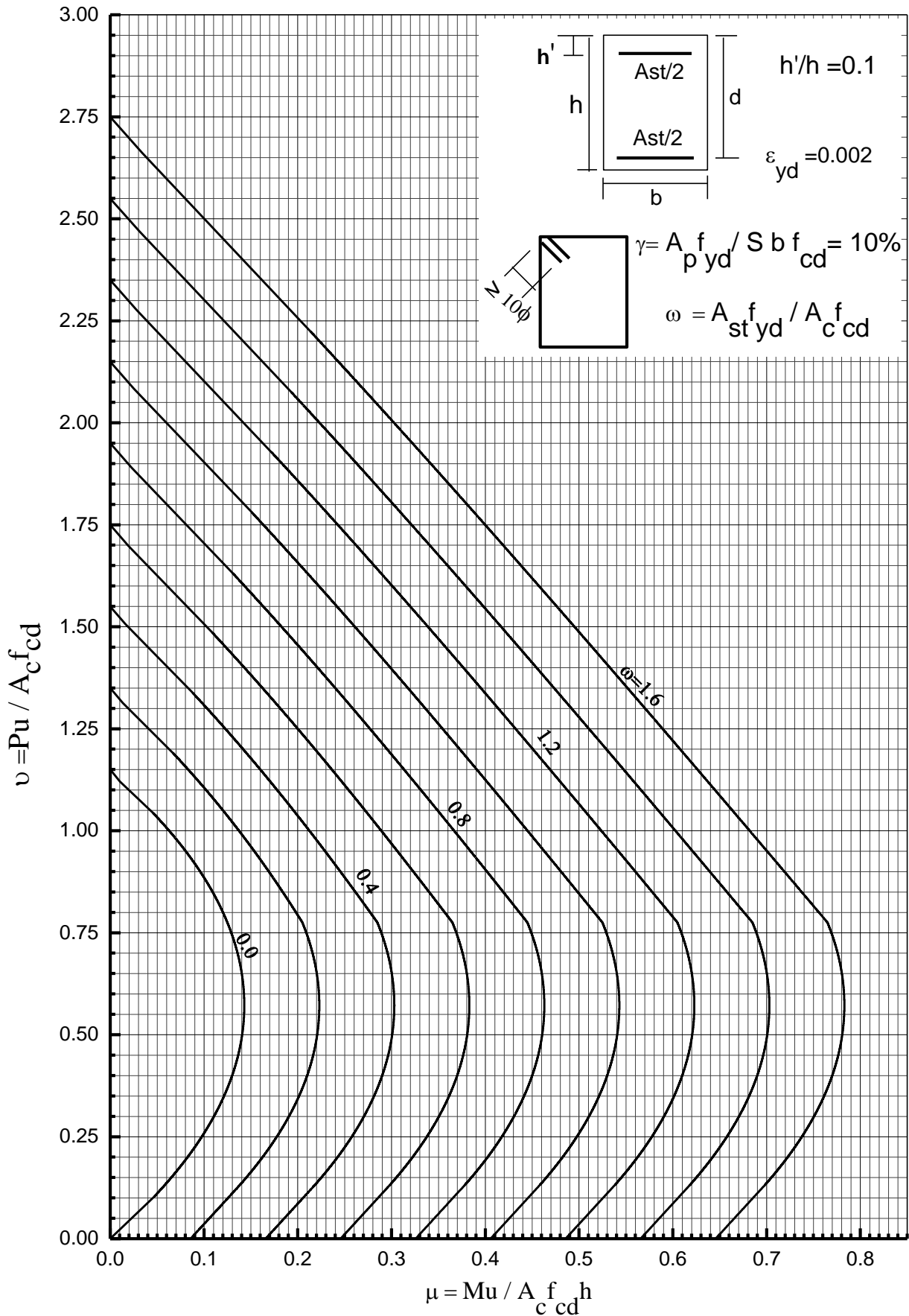

Uniaxial Interaction Chart of Reinforced Concrete Column Confined
by Transverse Reinforcement

Uniaxial Chart R4

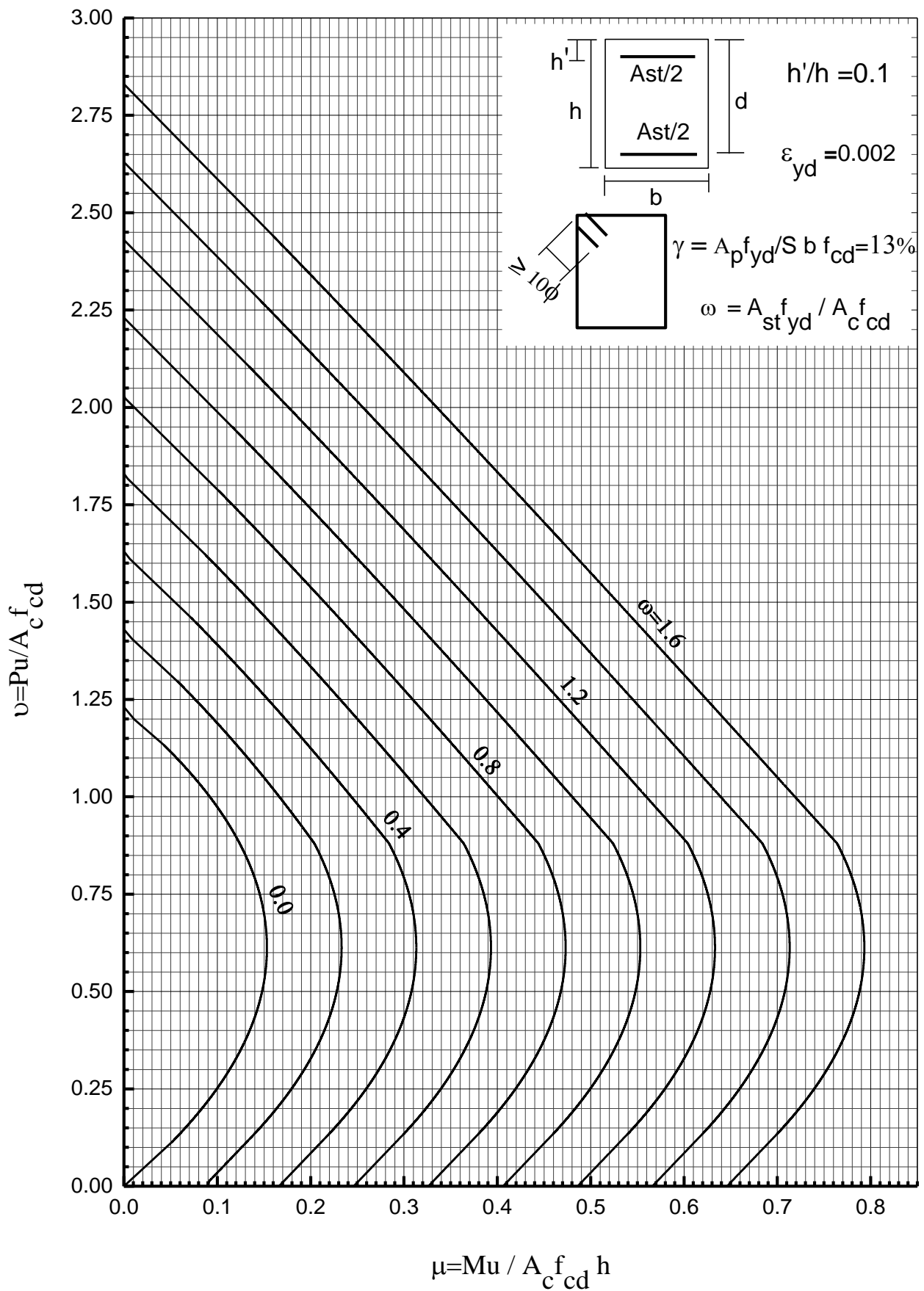

Uniaxial Interaction Chart of Reinforced Concrete Column Confined
by Transverse Reinforcement

Uniaxial Chart R5

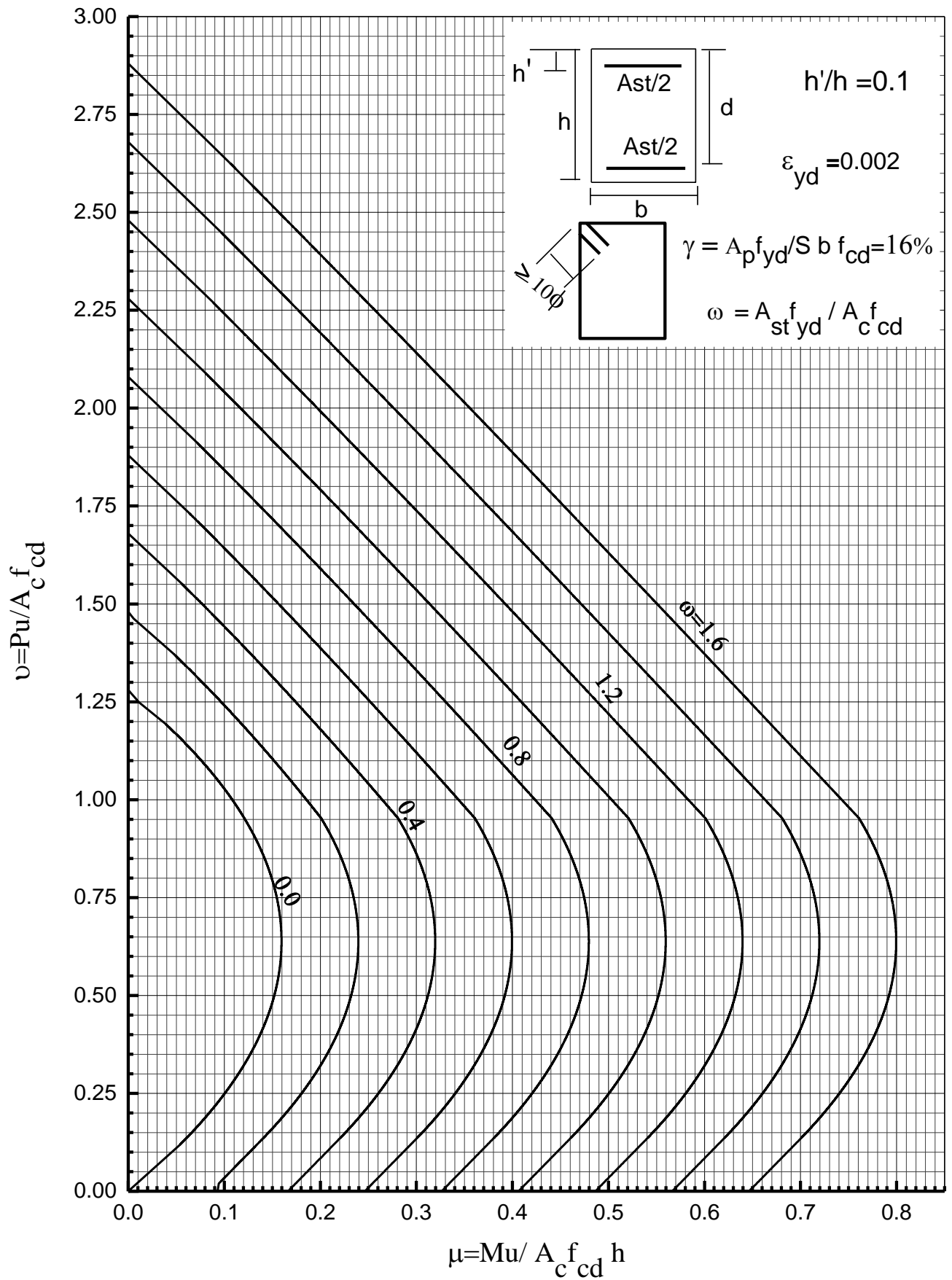

Uniaxial Interaction Chart of Reinforced Concrete Column Confined
by Transverse Reinforcement

Uniaxial Chart R6

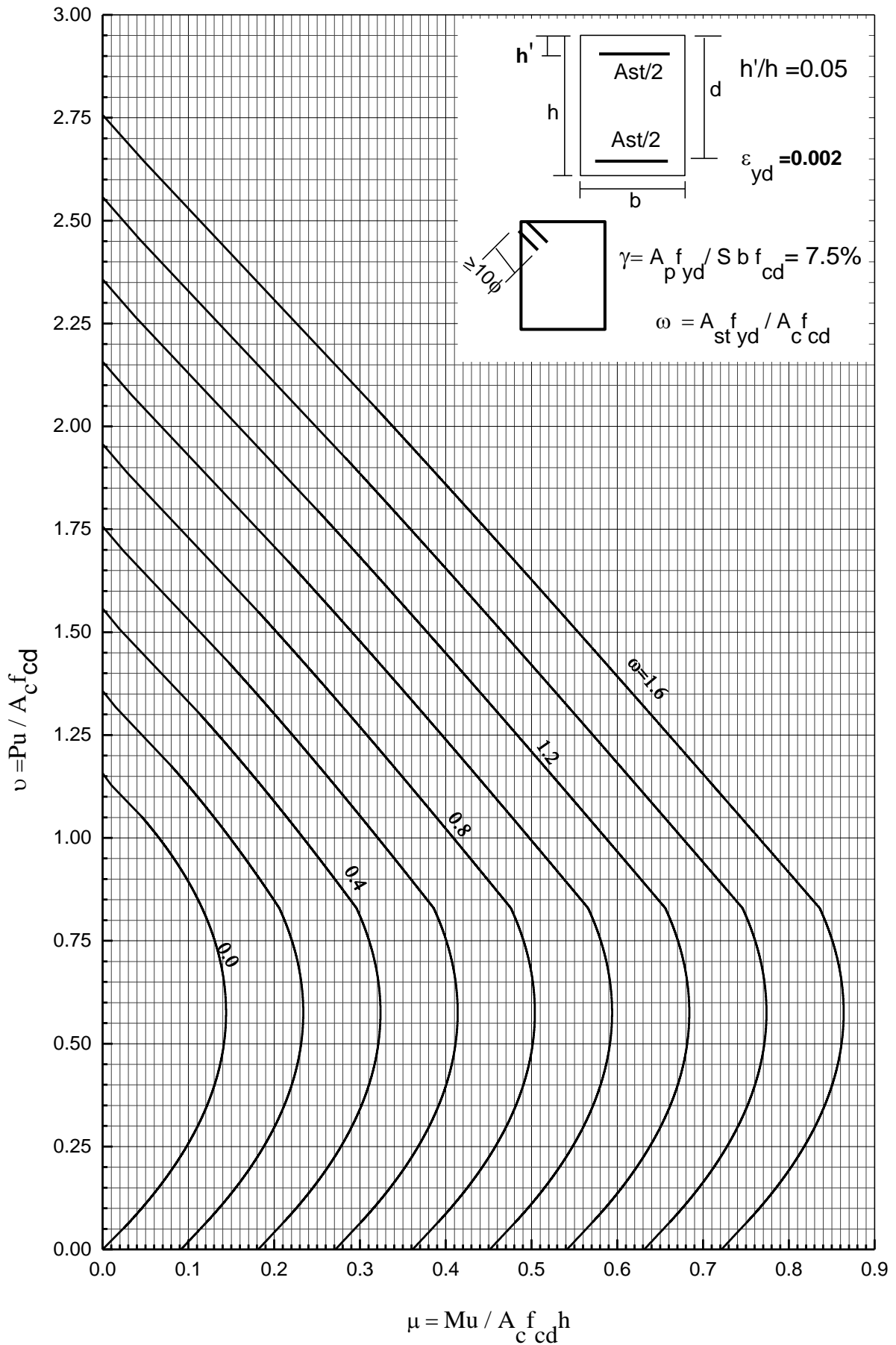

Uniaxial Interaction Chart of Reinforced Concrete Column Confined
by Transverse Reinforcement

Uniaxial Chart R7

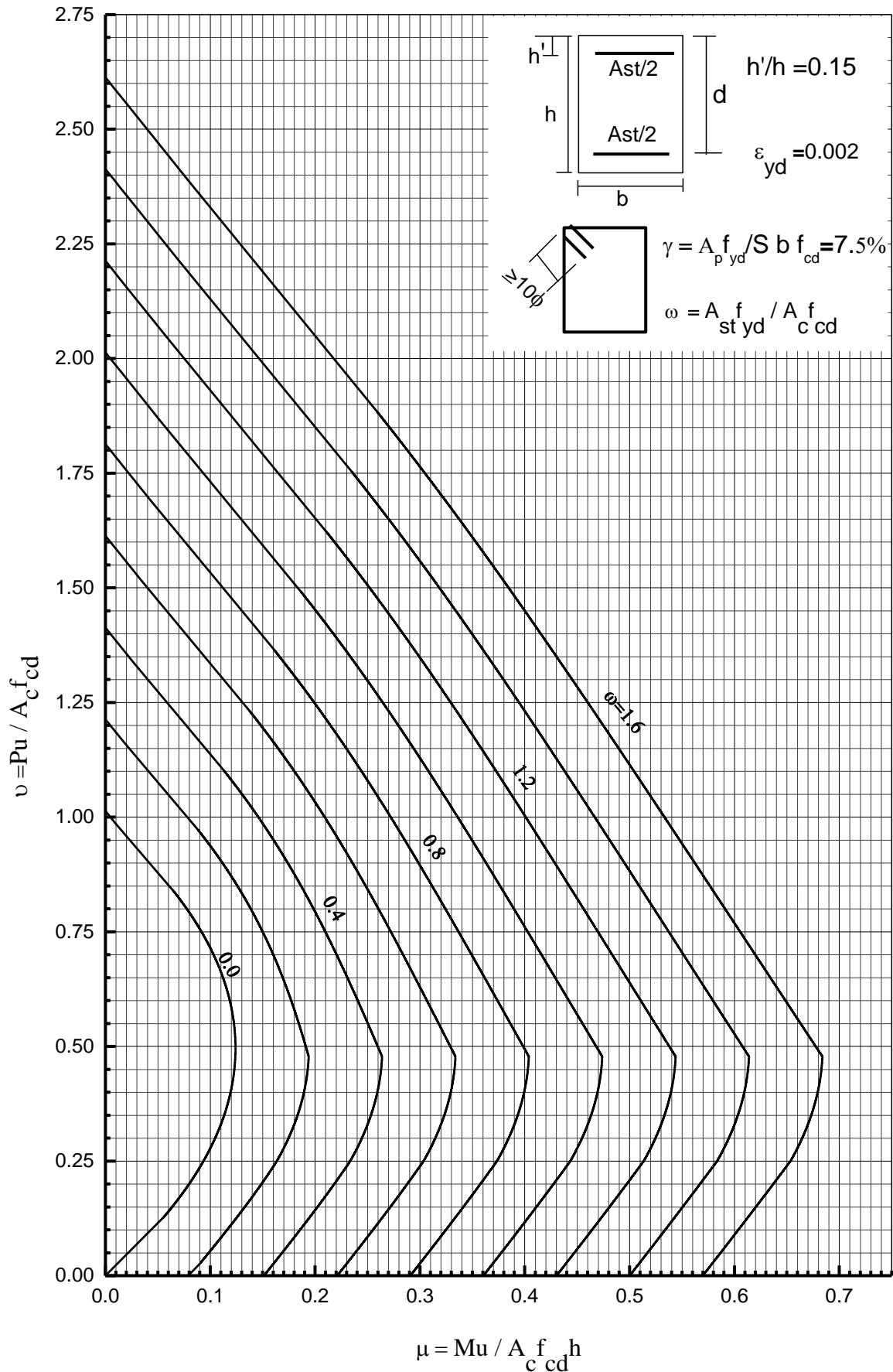

Uniaxial Interaction Chart of Reinforced Concrete Column Confined
by Transverse Reinforcement

Uniaxial Chart R8

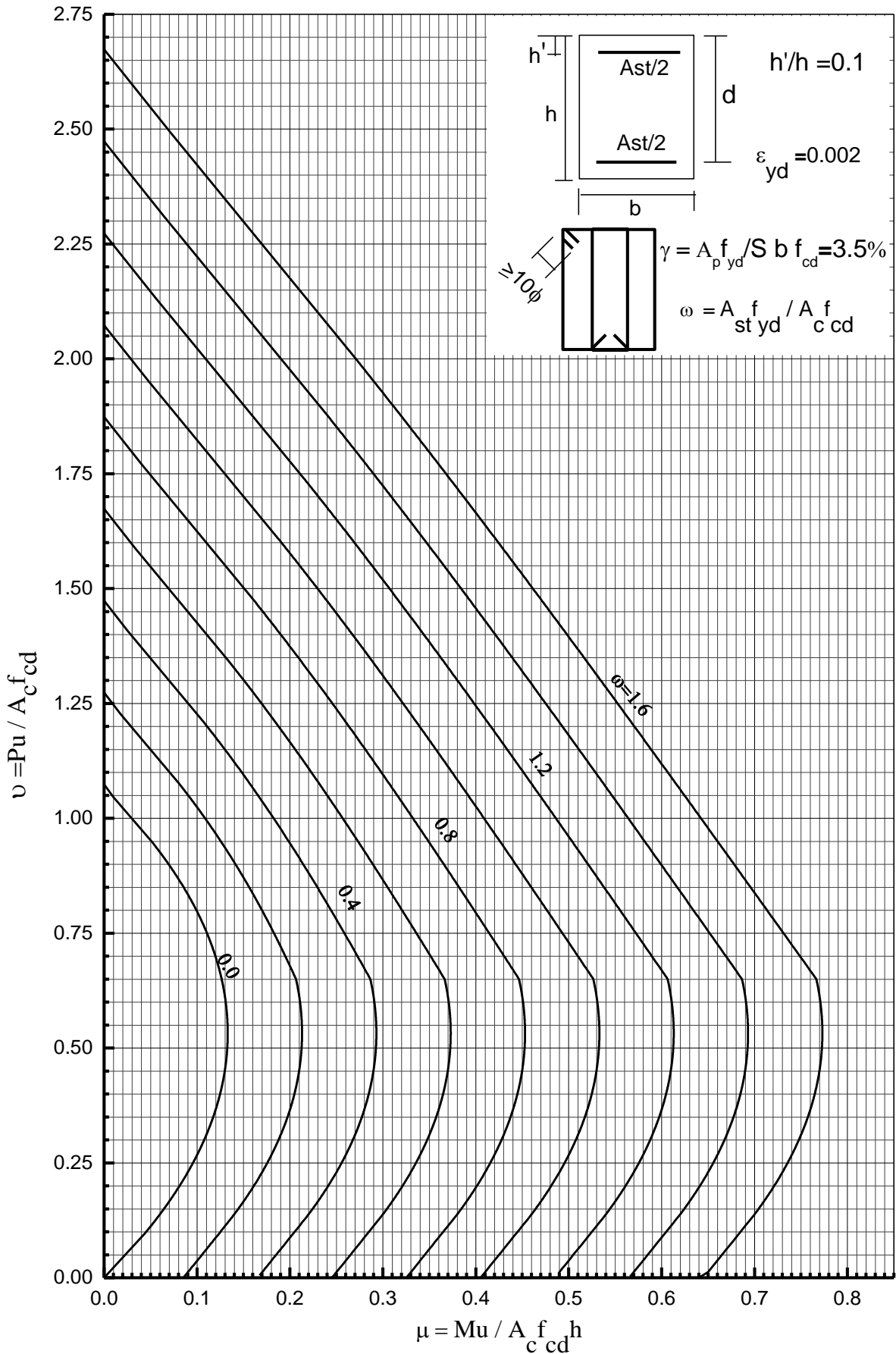

Uniaxial Interaction Chart of Reinforced Concrete Column Confined
by Transverse Reinforcement

Uniaxial Chart R9

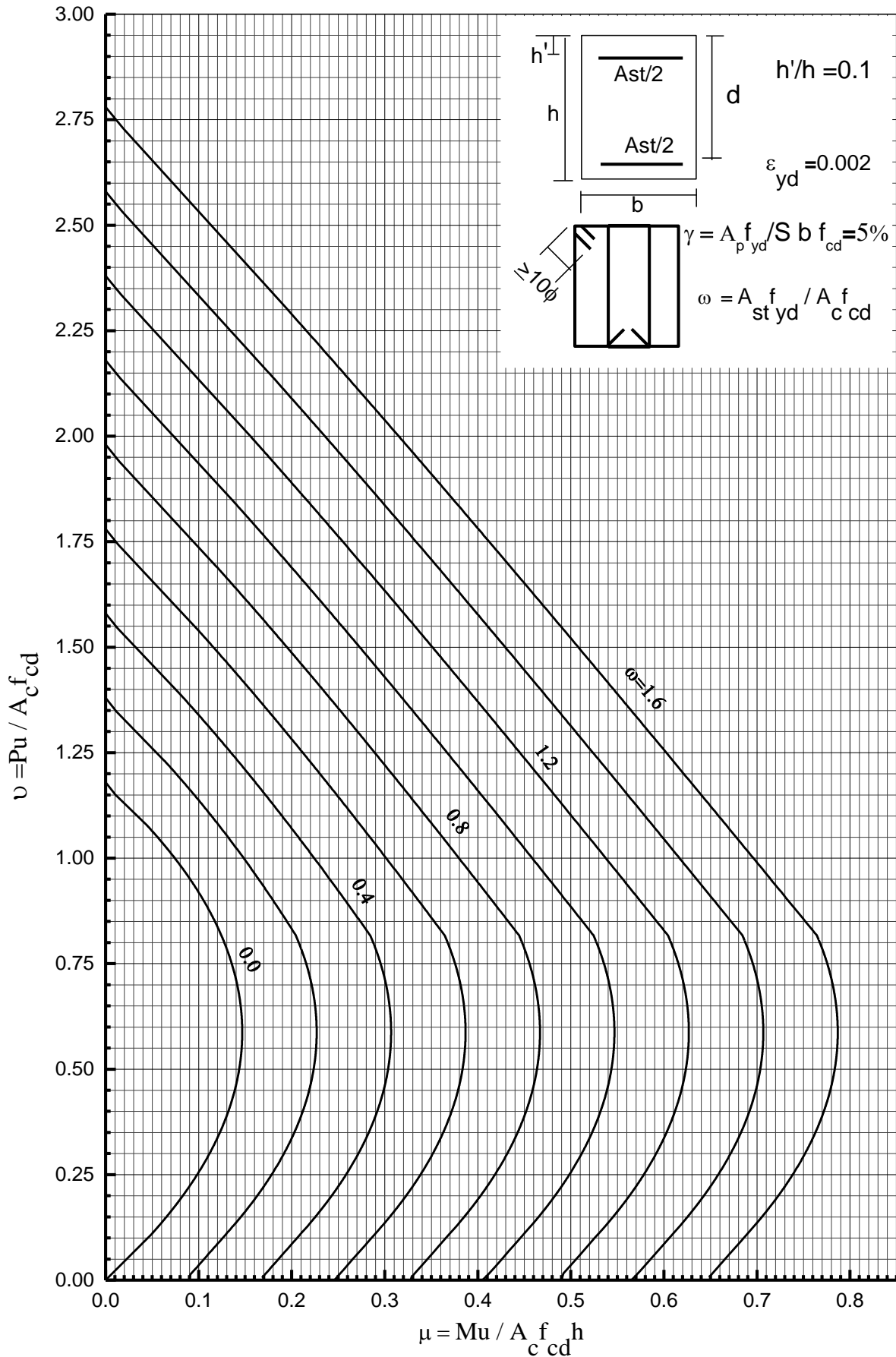

Uniaxial Interaction Chart of Reinforced Concrete Column Confined
by Transverse Reinforcement

Uniaxial Chart R10

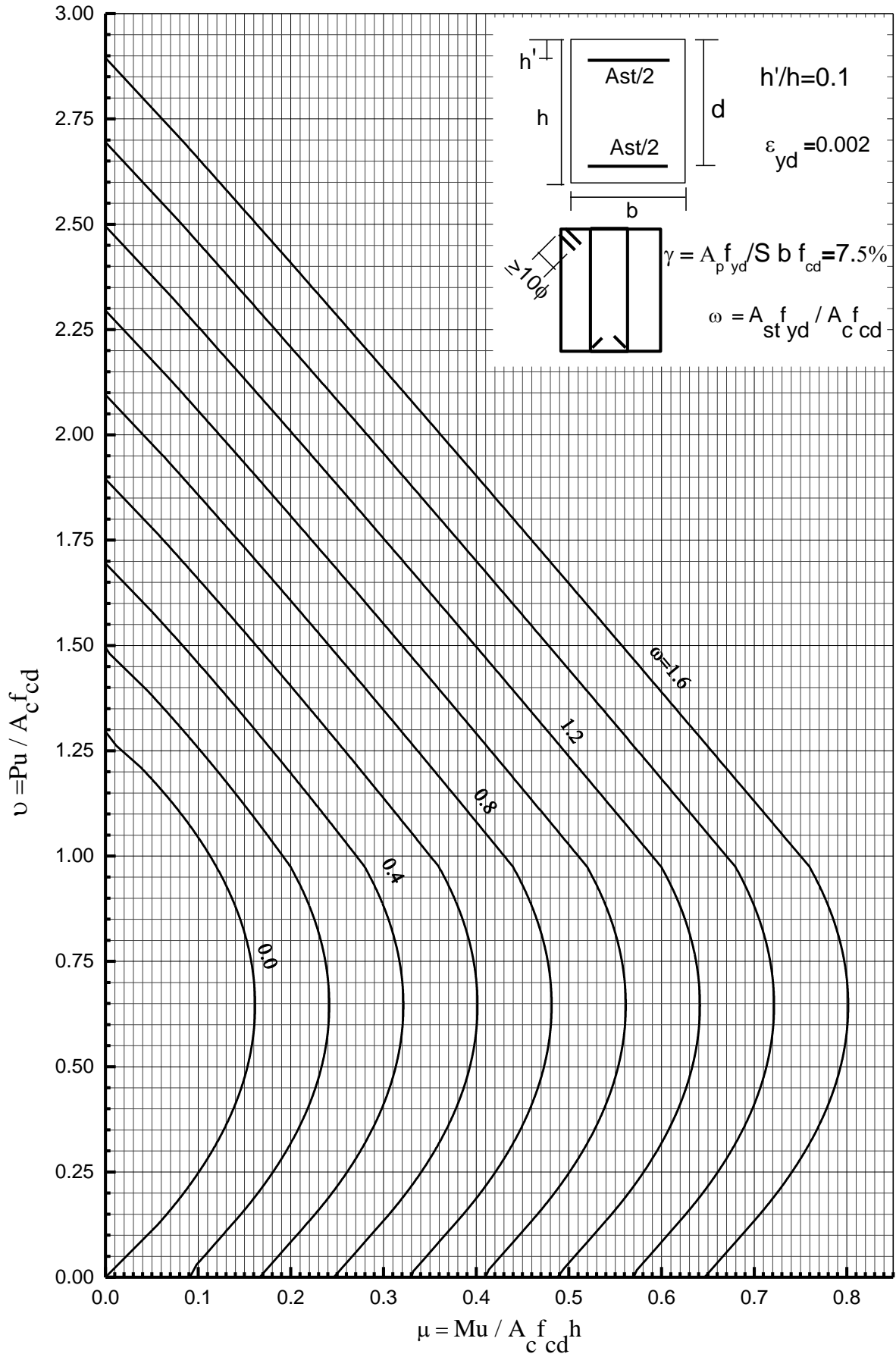

Uniaxial Interaction Chart of Reinforced Concrete Column Confined
by Transverse Reinforcement

Uniaxial Chart R11

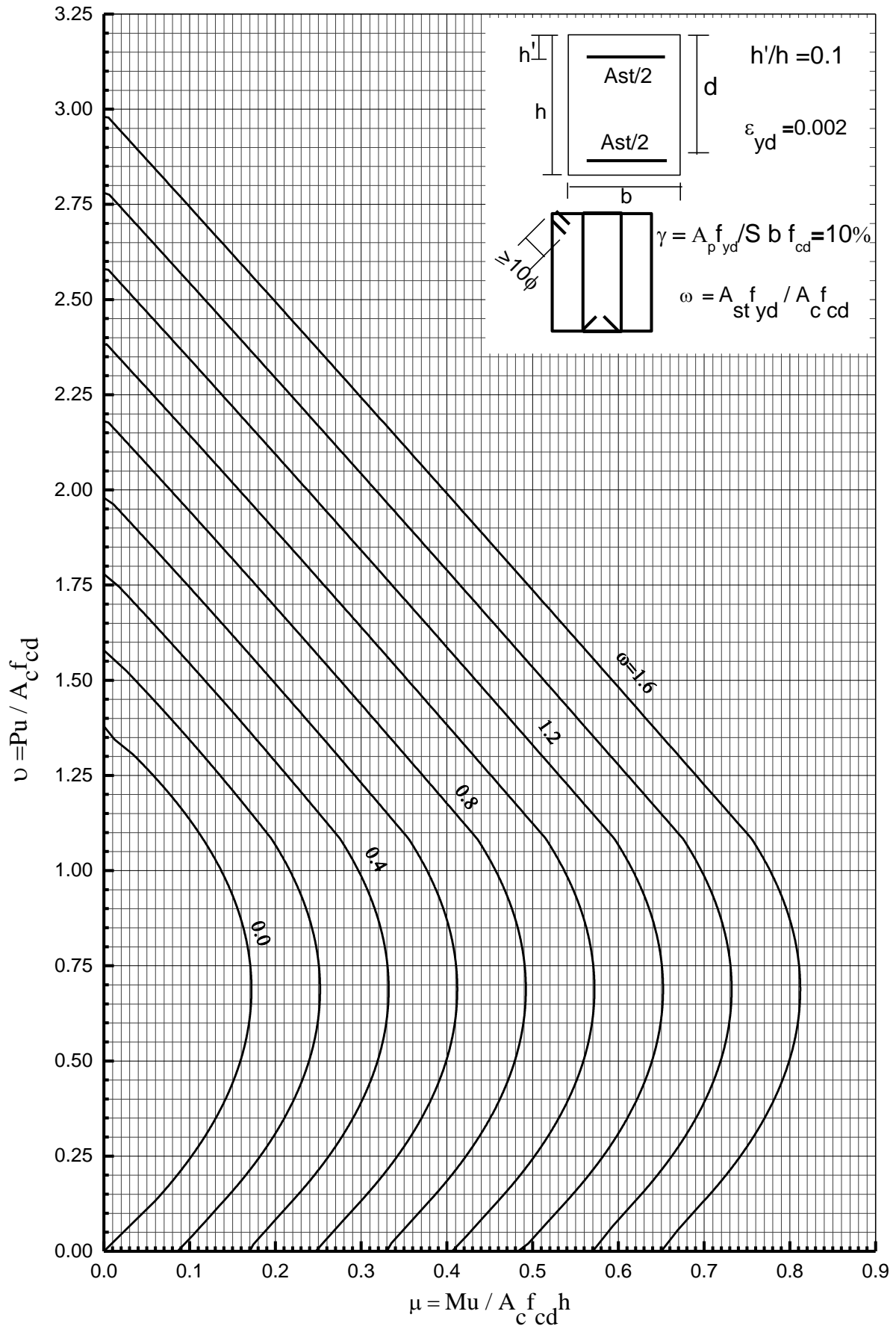

Uniaxial Interaction Chart of Reinforced Concrete Column Confined
by Transverse Reinforcement

Uniaxial Chart R12

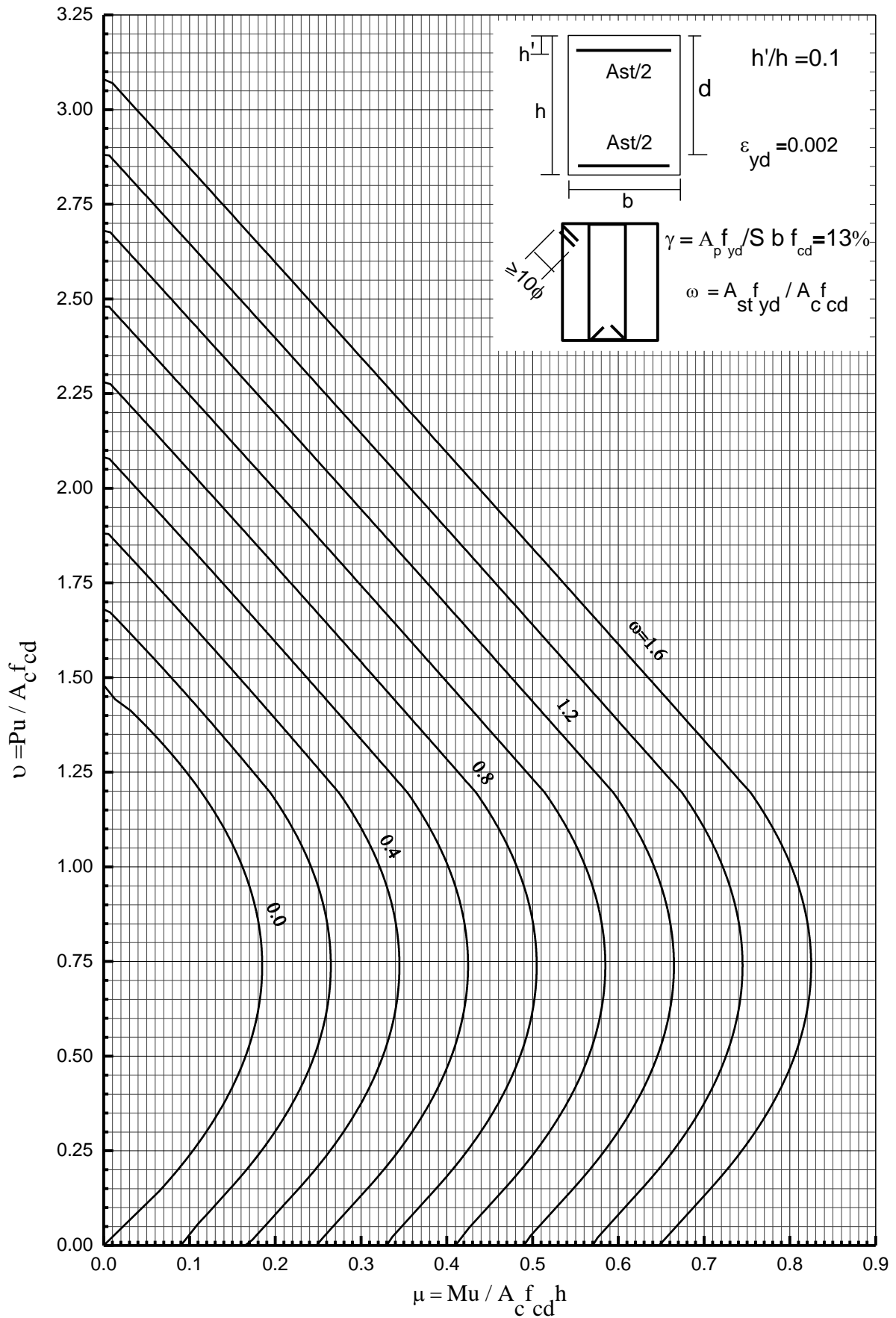

Uniaxial Interaction Chart of Reinforced Concrete Column Confined
by Transverse Reinforcement

Uniaxial Chart R13

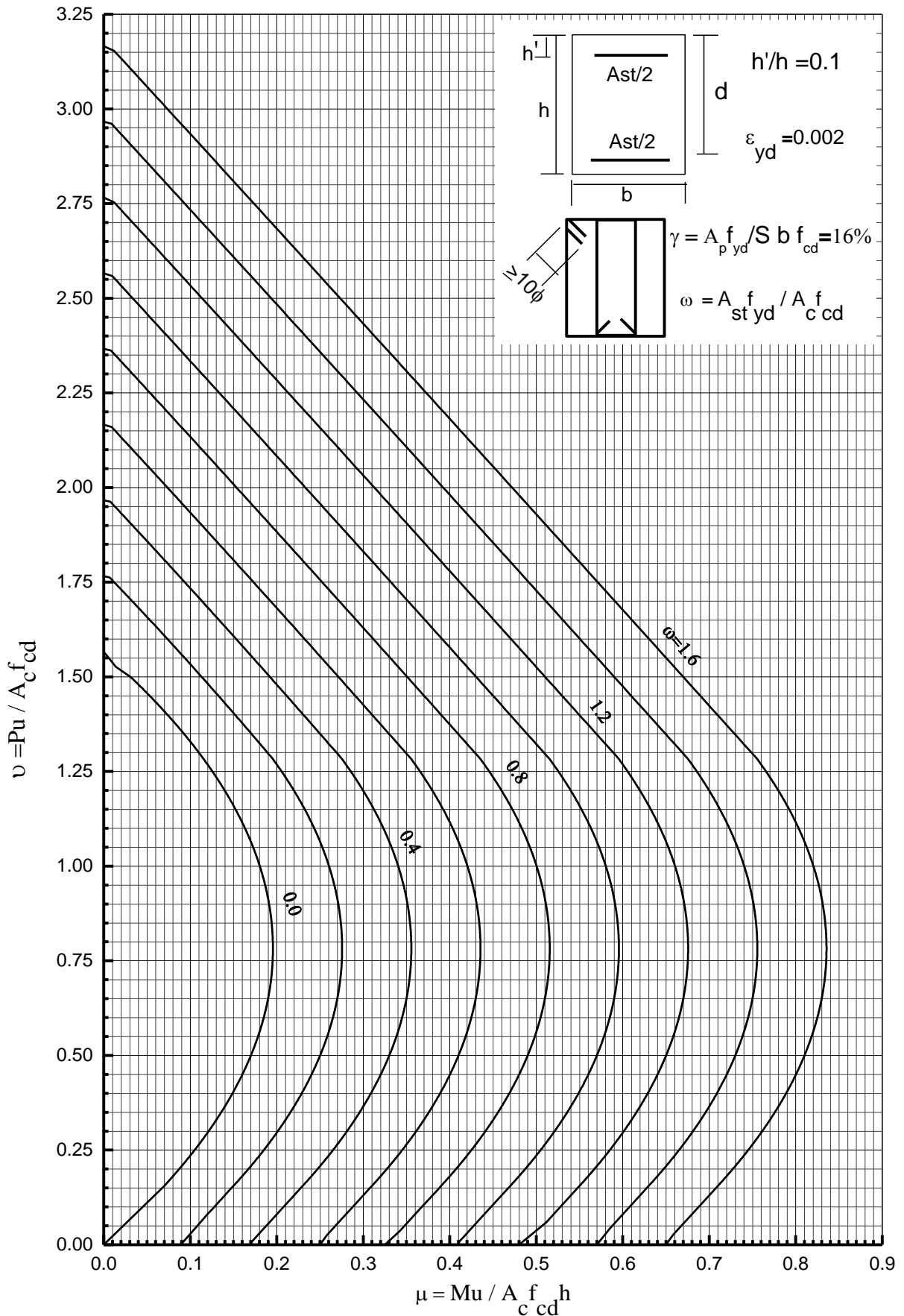

Appendix E: Uniaxial Design Chart of Confined RC Circular Column

Uniaxial Chart C1

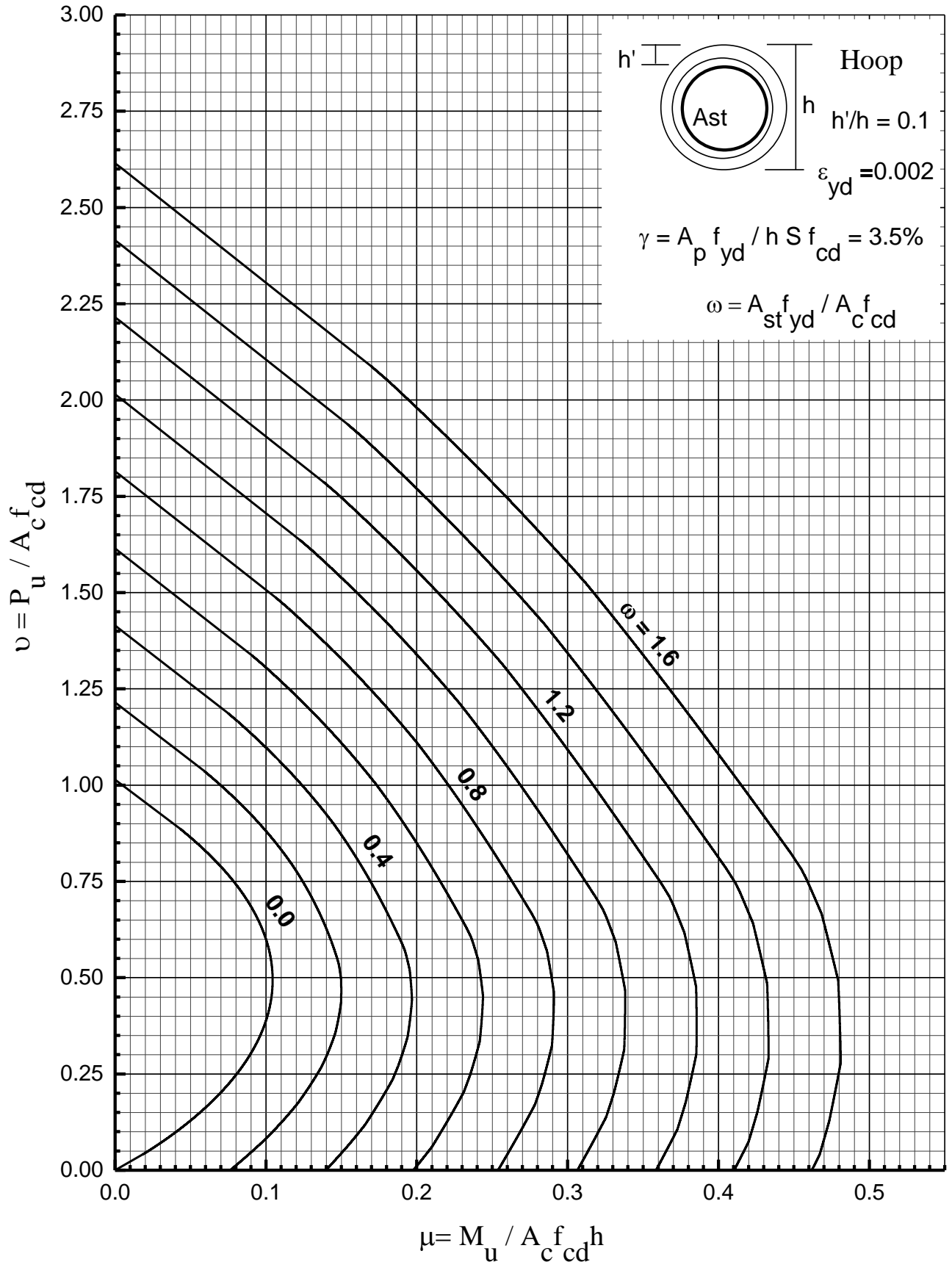

Uniaxial Interaction Chart of Reinforced Concrete Column Confined
by Transverse Reinforcement

Uniaxial Chart C2

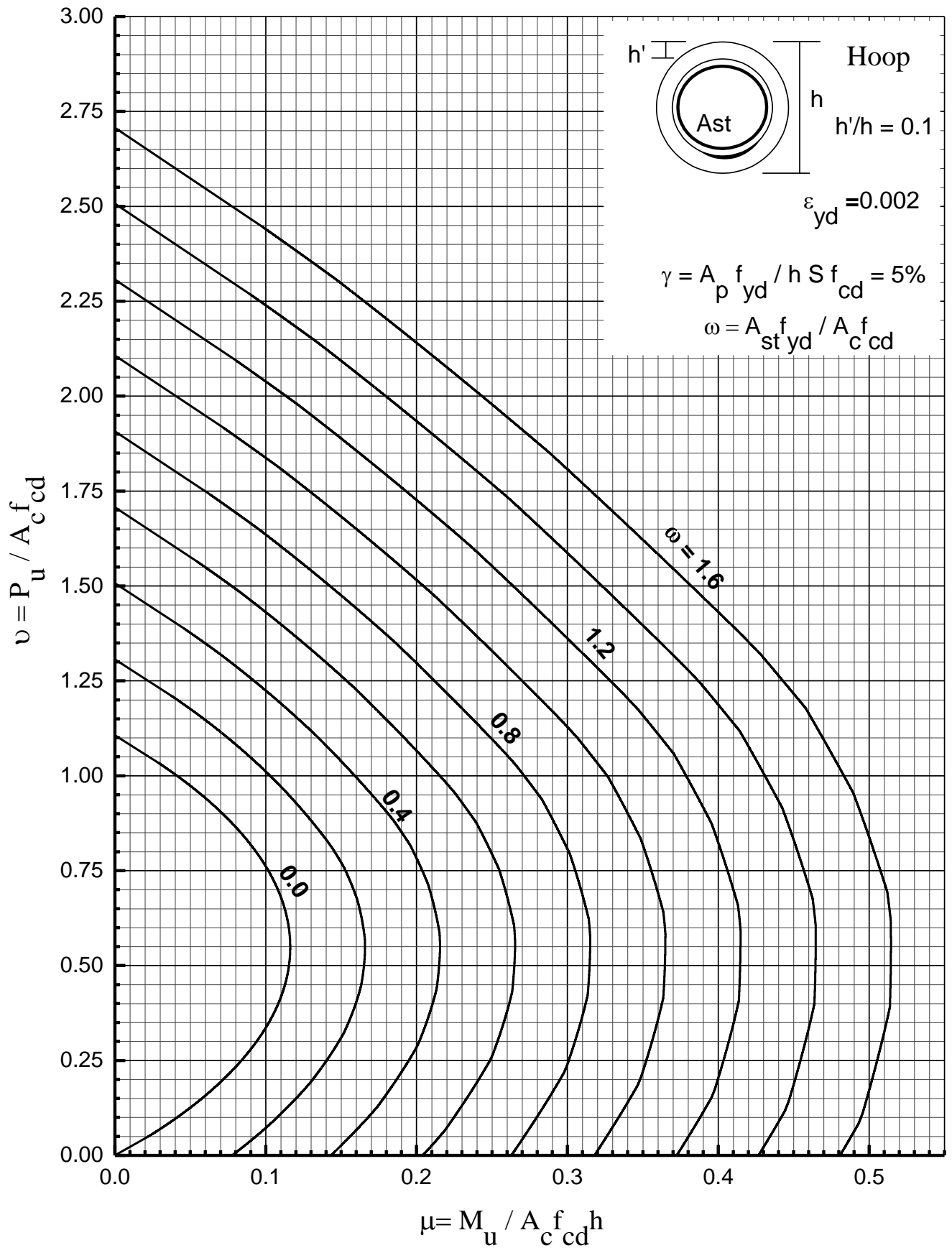

Uniaxial Interaction Chart of Reinforced Concrete Column Confined
by Transverse Reinforcement

Uniaxial Chart C3

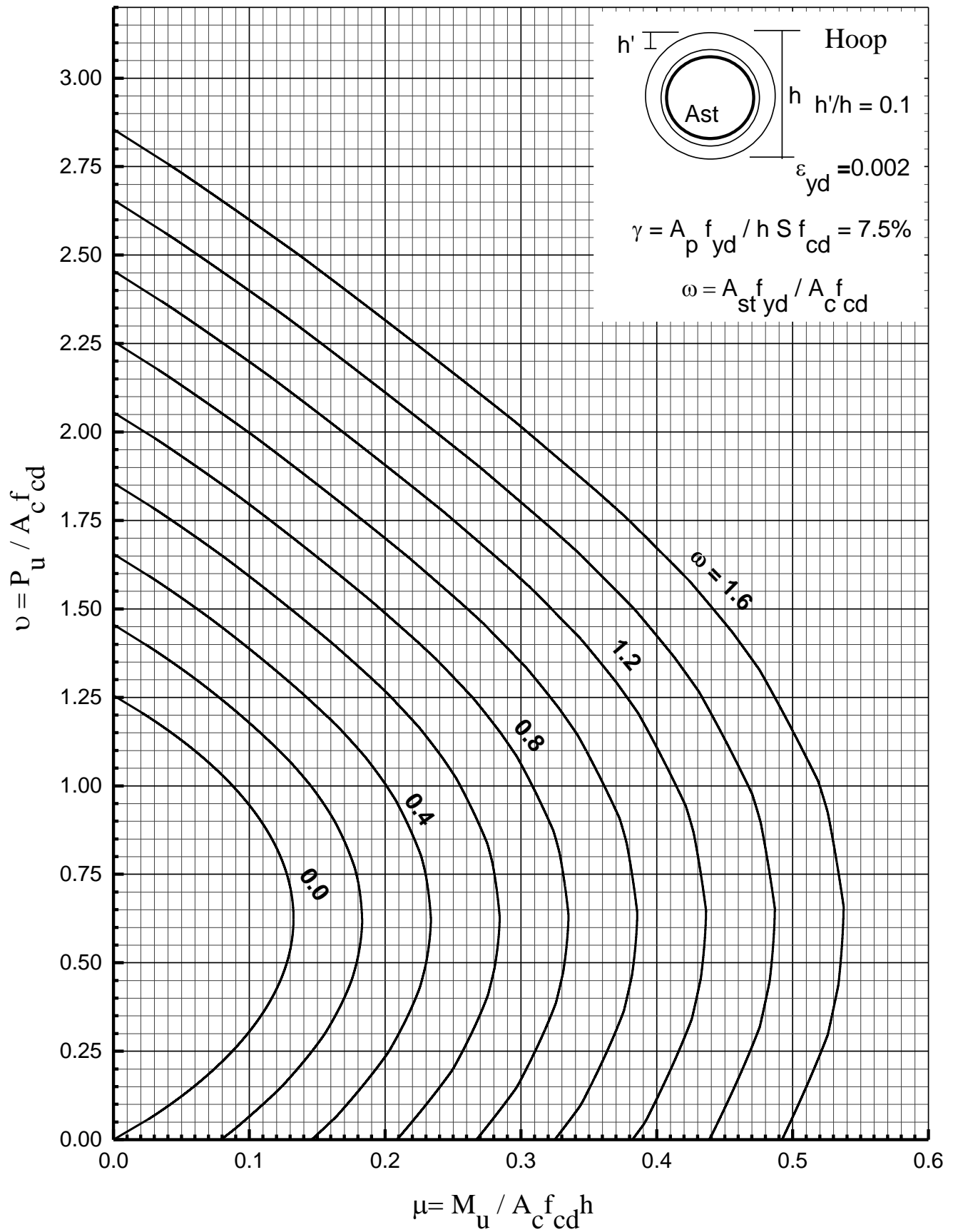

Uniaxial Interaction Chart of Reinforced Concrete Column Confined
by Transverse Reinforcement

Uniaxial Chart C4

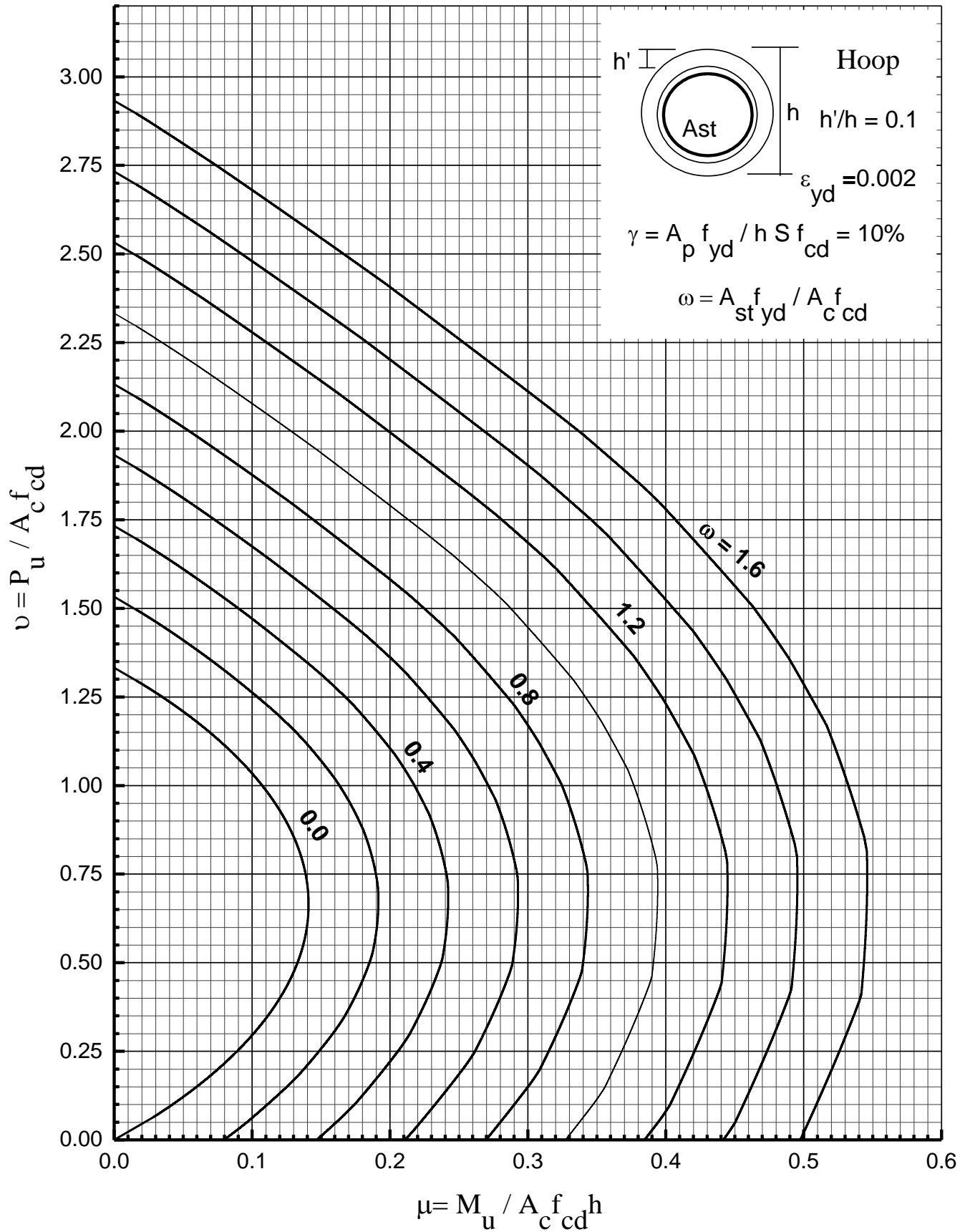

Uniaxial Interaction Chart of Reinforced Concrete Column Confined
by Transverse Reinforcement

Uniaxial Chart C5

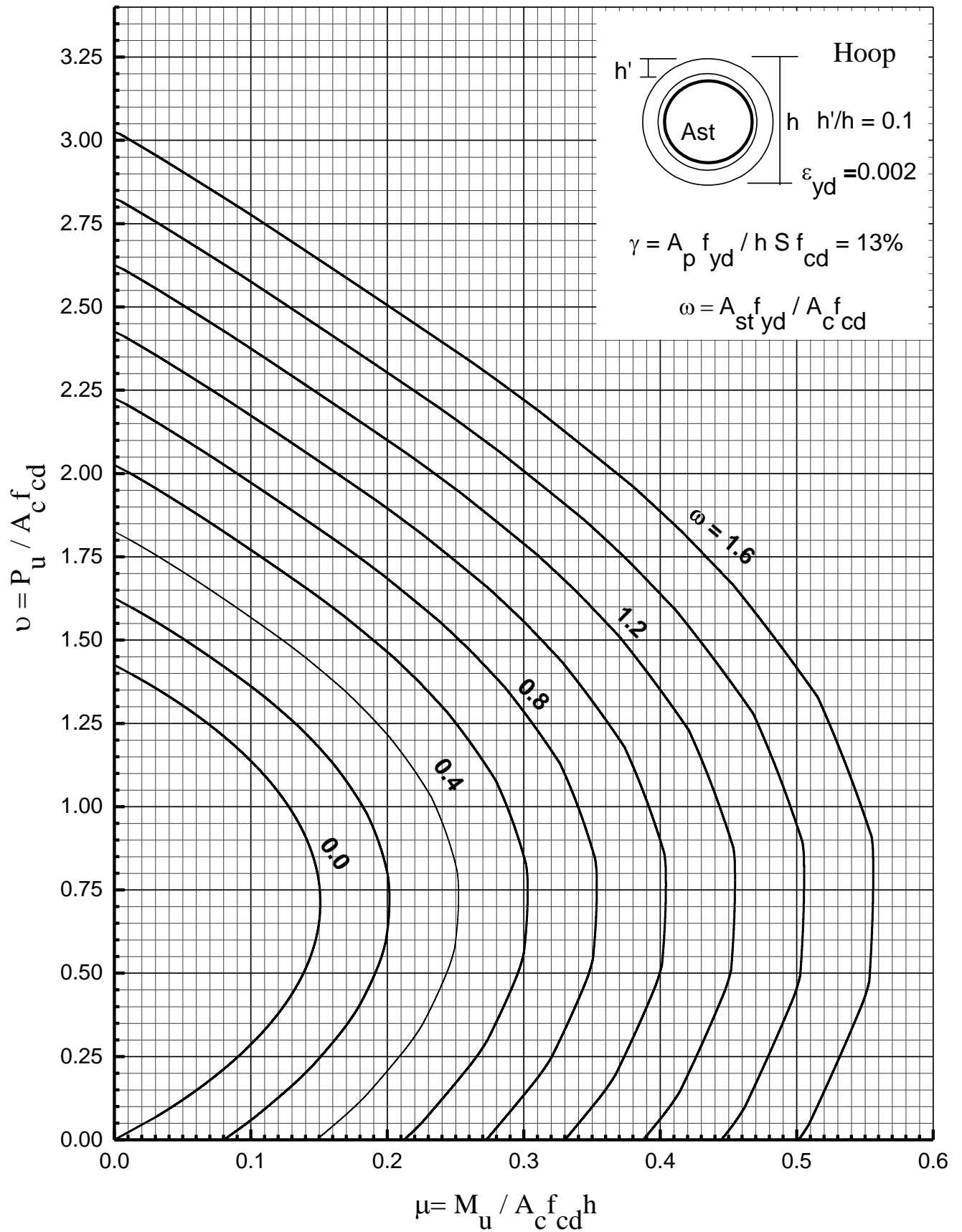

Uniaxial Interaction Chart of Reinforced Concrete Column Confined
by Transverse Reinforcement

Uniaxial Chart C6

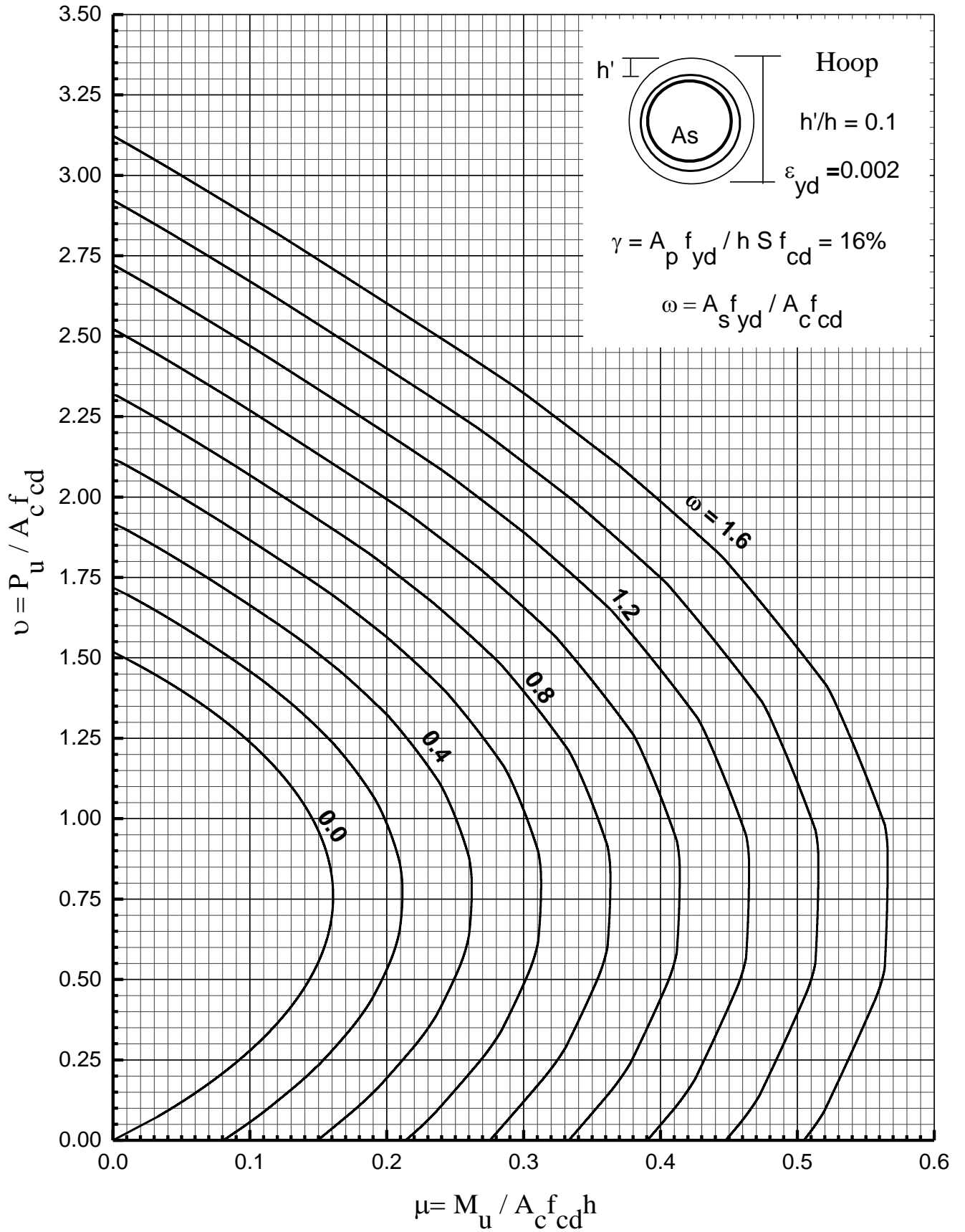

Uniaxial Interaction Chart of Reinforced Concrete Column Confined
by Transverse Reinforcement

Uniaxial Chart C7

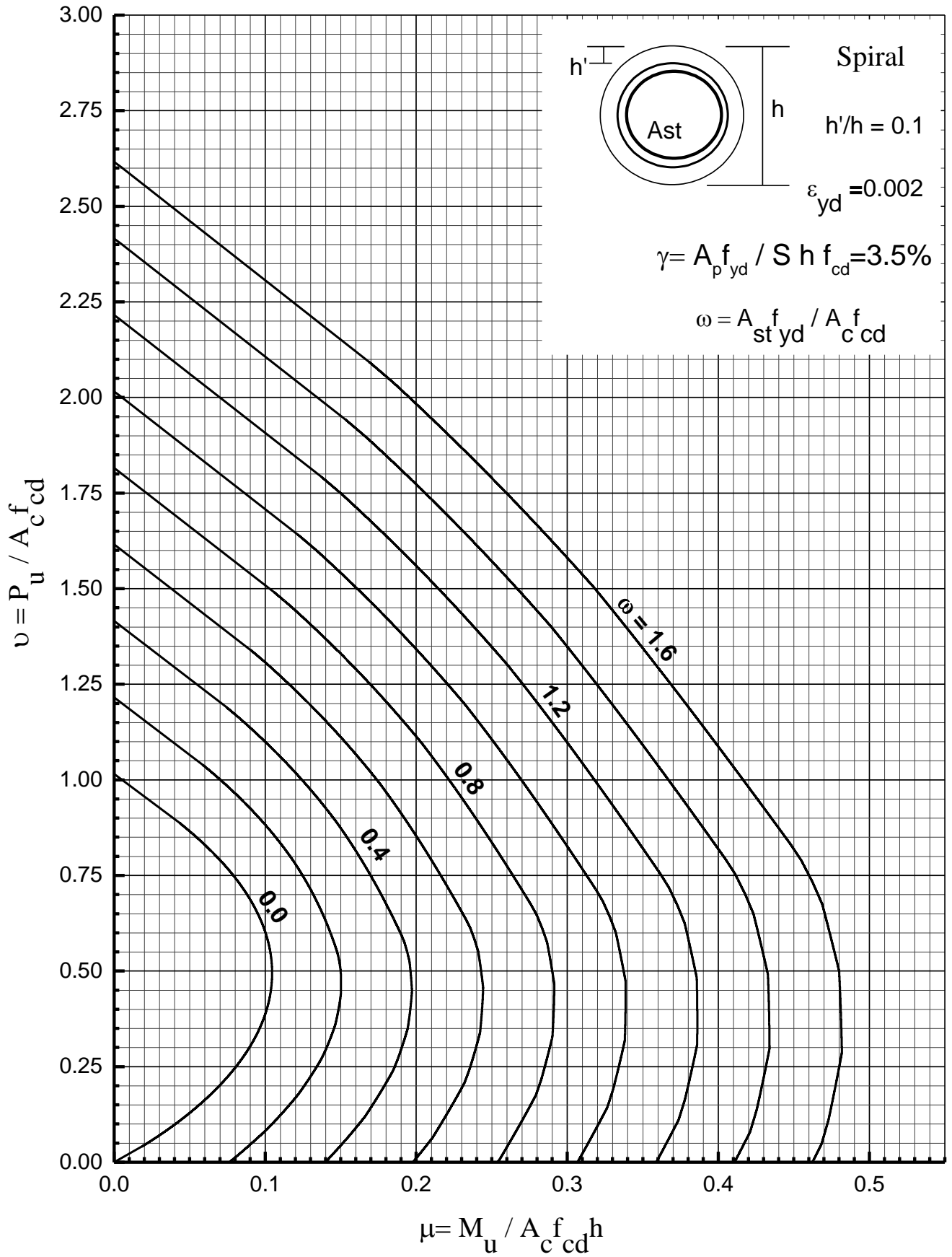

Uniaxial Interaction Chart of Reinforced Concrete Column Confined
by Transverse Reinforcement

Uniaxial Chart C8

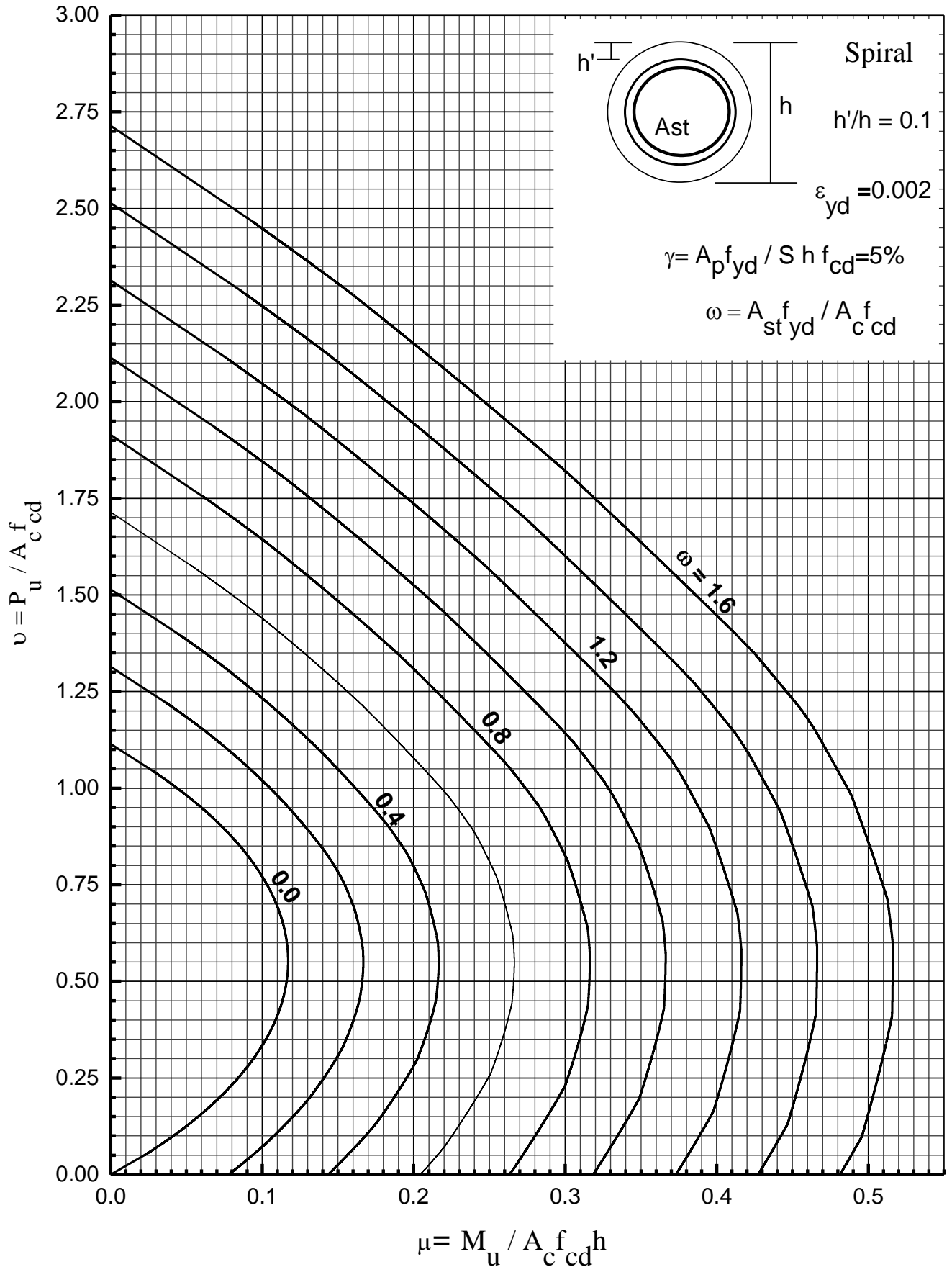

Uniaxial Interaction Chart of Reinforced Concrete Column Confined
by Transverse Reinforcement

Uniaxial Chart C9

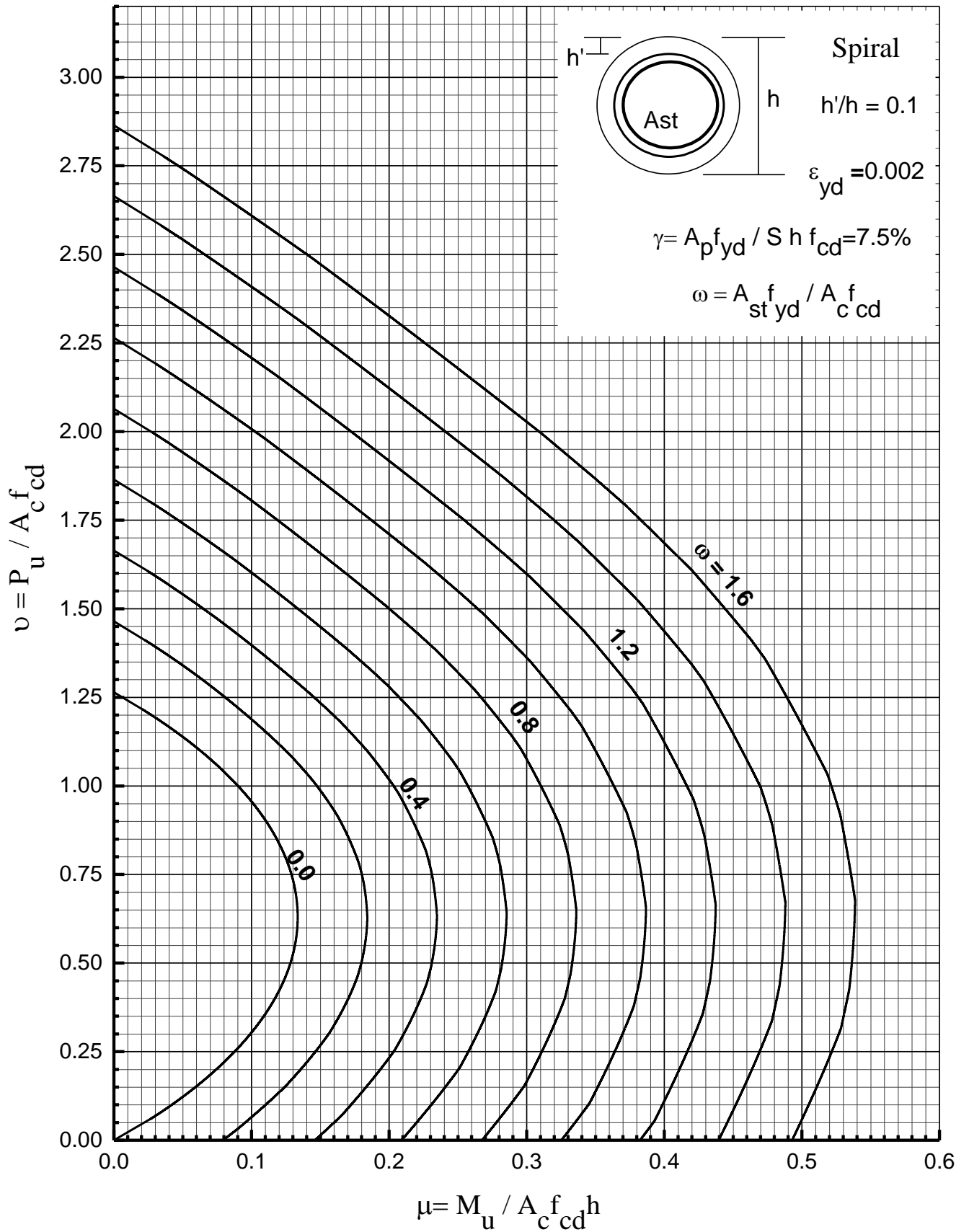

Uniaxial Interaction Chart of Reinforced Concrete Column Confined
by Transverse Reinforcement

Uniaxial Chart C10

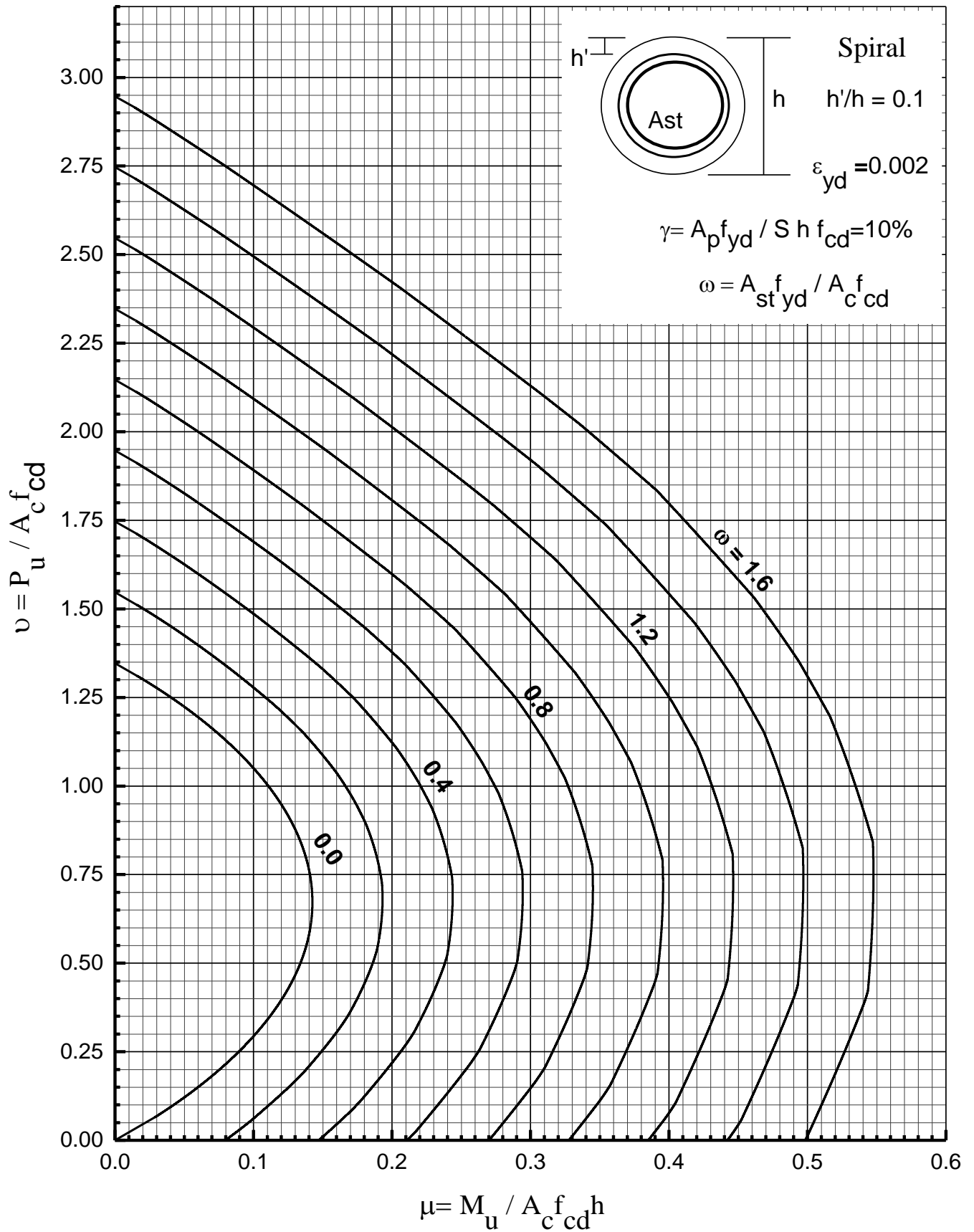

Uniaxial Interaction Chart of Reinforced Concrete Column Confined
by Transverse Reinforcement

Uniaxial Chart C11

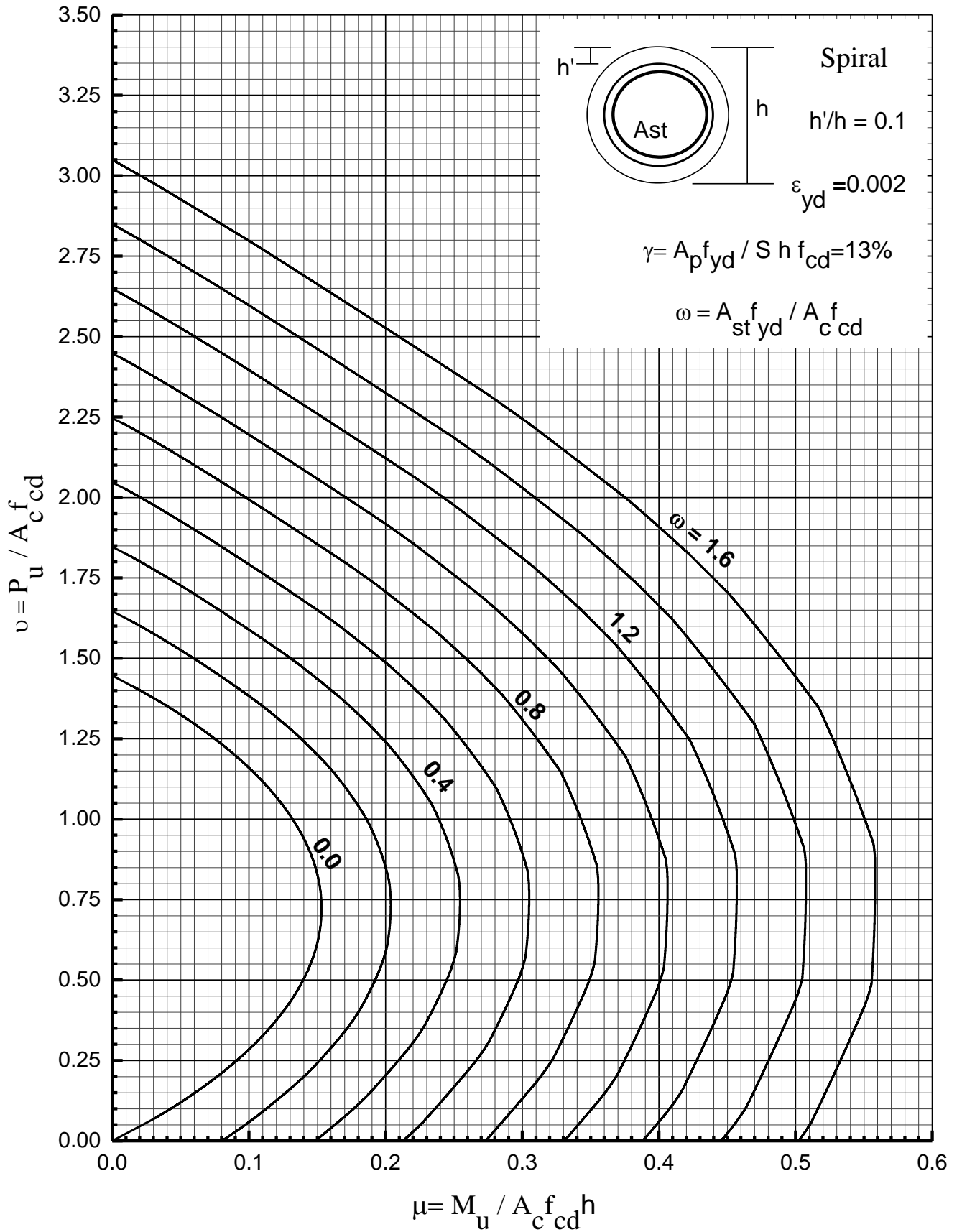

Uniaxial Interaction Chart of Reinforced Concrete Column Confined
by Transverse Reinforcement

Uniaxial Chart C12

