

Jimma University

Jimma Institute of Technology

Faculty of Mechanical Engineering

Thermal System Engineering

Design of Waste Heat Recovery System from Incinerator for Water Heating Application: The Case of Jimma University Referral Hospital.

A Thesis submitted to the School of Graduate Studies of Jimma University, in Partial Fulfillment of the Requirements for the Degree of Master of Science in Mechanical Engineering (Thermal System Engineering Stream).

BY

Temesgen Duguma

August, 2020

Jimma, Ethiopia

Declaration

I, the undersigned, declare that this thesis entitled “Design Waste heat recovery system from incinerator for water heating application: the case of Jimma University Referral Hospital” is my original work, and has not been presented by any other person for an award of a degree in this or any other university.

Name: Temesgen Duguma

Signature.....  13/08/2020

Approval by board of examiner

Signature

Date

1. Getachew Shunki Tibba (Dr. - Ing.)



11/08/2020

External Examiner

2. Balewize A. Zeru (PhD Candidate.)



13th Aug 2020

Main Advisor

3. Jemal Worku (MSc.)



13/08/2020

Internal Examiner

4. Sewayehu.T (MSc.)



13/08/2020

Co-advisor

5. Fikadu Kifle (MSc.)

Fikadu Kifle
Chair, Thermal System
Engineering /
Faculty of Mechanical
Engineering

Chairman

Acknowledgement

First and most of all, I would like to thank the almighty God for blessing and being with me in every step I pass through.

Then I would like to express my deepest gratitude to my advisor Balewize A. Zeru (Asst. prof.), For all his Support, sharing of knowledge and interesting discussions during my work. Sewayehu.T my co-advisor, should also be acknowledged and thanked for all his support.

I would also like to thank, Mr. Fikadu Kifle chairman of Thermal System Engineering for his kind preliminary advice and consult.

A special thanks address to Jimma University, Institute of Technology, and Mechanical Department Thermal Engineering staff and all my classmate students and friends for their support until the completion of the study.

I am also very grateful to Assosa University for sponsoring my MSc Study at the Faculty of Mechanical Engineering, Jimma Institute of Technology.

Last, but not least, I would like to thank my dear family for all their support and love. Without You this journey would not have been possible.

Abstract

Energy recovery system of hospital waste heat to useful energy units represents a substantial part of the whole technology which enables to utilize heat contained in flue gas (off-gas) from incinerators or combustion chambers as much as possible. This thesis deals with Modeling Waste heat recovery system from incinerator for water heating application: the case of JURH. For high temperature applications, there are many sources of thermal waste heat, and several recovery systems and potential useful applications have been proposed by researchers.

Therefore in this research work an attempt has been made to design and analyses of shell and tube heat exchanger for water heater. The amount of hot water supplied to the hospital throughout the day and the energy needed to heat the demanded hot water. This energy mainly comes from the waste which is discarded from hospital including administrative staff by incineration. A bomb calorimeter is used to determine the energy content of each waste. The total energy available is 26596.6MJ or 7387.95kwh and the energy needed to heat or raise temperature by 1 °C of one liter of water is 4.186kj/kg. A heat exchanger is a heat transfer device to provide heat transfer thermal energy between two or more fluids, between a solid surface and a fluid, or between solid particulates and a fluid available, at different temperatures. The flow is counter flow; on the other hand, the hot and cold fluids enter the heat exchanger at opposite ends and flow in opposite directions. This means One fluid runs through the tubes, and another fluid flows over the tubes (through the shell) to transfer heat between the two fluids. The design procedures are followed by thermal design specification of shell and tube heat exchanger.

The energy and cost saving potential is closely linked to the flow of heat in the hospital incinerator in most cases. The basic idea behind waste heat recovery is to try to recover maximum amounts of heat in the incinerator and to reuse it as much as possible, instead of just releasing it into the air or a nearby river. The saving of energy in general became therefore mandatory, being the recovery of the heat from waste flue gases of incineration plants of hospitals one of the possible ways of saving energy. Thus by recovering flue gas 475.25kwh of energy per day is saved and converting this energy in to fee 256.63ETB per day is saved.

Key Word: waste heat recovery, shell and tube heat exchanger, hot water demand, energy and cost saving

Abbreviations

EEPCO	Ethiopian Electric Power Corporation
WHR	Waste Heat Recovery
JURH	Jimma University Referral Hospital
WtE	Waste to Energy
GCV	Gross Calorific Value
NCV	Net Calorific Value
HHV	Higher Heating Value
LHV	Lower Heating Value
CFD	Computational Fluid Dynamics
DHWRIS	Domestic Hot Water Recovery from Incinerator System
HWD	Hot Water Demand
TDHWD	Total Daily Hot Water Demand
PVC	Polyvinyl Chloride
VCM	Volatile Combustible Material
PET	Polyethylene Terephthalate
MSW	Municipal Solid Waste
OD	Outer Diameter
TEMA	Tubular Exchanger and Manufacturing Associations
STHE	Shell and Tube Heat Exchanger
MW	Medical Waste
BWG	Birmingham Wire Gauge

List of tables

Table2. 1 Features of shell and tube type exchanger	11
Table3. 1 typical waste generation from JURH.....	16
Table4. 1 Data from JUR Hospital	21
Table4. 2 Standard Hot Water Demand for Hospital.....	21
Table4. 3 Hot Water Demand for each Appliance of the Hospital.....	22
Table4. 4 Hot water demand of the Jimma Hospital per Services.....	24
Table4. 5 Total Hot water demand of the Hospital per Services	24
Table5.1 specifications of fluid properties.....	29
Table5.2 fluid properties.....	29
Table5.3 Constants for use in equation.....	30
Table5.4 Common tube layouts	32
Table5.5 Guidelines for placing the fluid in order of priority	35
Table5.6 Heat exchanger dimension.....	42
Table5.7 boundary condition setup.....	43
Table5.8 residuals	44
Table6. 1 Mass distribution of combustible waste categories	45
Table6. 2 Result of proximate analysis and calorific value from Ethiopian geological survey laboratory.....	46
Table6. 3 Result of Ultimate analysis from AAU of college of natural science chemistry department	47
Table6. 4 Result of calorific value.....	48

List of figures

Figure2. 1 Classification of heat exchangers depending on their applications.....	10
Figure3. 1 map of study area.....	14
Figure3. 2 waste heat recovery flow diagram.....	18
Figure3. 3 working principle of shell and tube heat exchanger.....	19
Figure4. 1 Daily Hot Water Demand of each Appliance.....	25
Figure 4. 2 Hot Water Demand Distribution over the Time of the Day.....	25
Figure5.1 Schematic of one-shell one-pass (1-1) shell-and-tube heat exchanger.....	27
Figure5.2 Temperature profiles of Counter- flow heat exchanger.....	28
Figure5.3 Heat exchanger tube-layout.....	32
Figure5.4 Cut-segmental baffle.....	34
Figure5.5 Idealized main stream flow.....	38
Figure5.6 Equivalent diameter, cross-sectional areas and wetted perimeters.....	38
Figure5.7 Simplified geometry of shell and tube heat exchanger.....	42
Figure5.8 sectioning of meshes and show whole element.....	43
Figure6. 1 residue for STHX model,5000 iteration.....	48
Figure6. 2 Temperature contour on z-x plane.....	49
Figure6. 3 Temperature contour at tube inlet.....	50
Figure6. 4 Temperature contour at shell inlet.....	51
Figure6. 5 Temperature contour on shell outlet.....	52
Figure6. 6 Temperature contour at tube outlet.....	53
Figure6. 7 animated result of velocity streamline.....	54
Figure6. 8 velocity contour on z-x plane.....	55
Figure6. 9 pressure contour on z-x plane.....	56

Table of Contents

Page No

Declaration	i
Acknowledgement	ii
Abstract	iii
Abbreviations	iv
List of tables	v
List of figures	vi
CHAPTER ONE	1
1. INTRODUCTION	1
1.1. Background	1
1.2. Statement of the Problem	2
1.3. Significance of the study	3
1.4. Objectives	3
1.4.1 General Objective	4
1.4.2 Specific objective	4
1.5. Scope of the study	4
CHAPTER TWO	4
2. Literature Review.....	5
2.1 The overview of recovering waste heat from hospital incinerator	5
2.2. Research gap	8
2.3 Basics of the combustion process in the hospital waste incinerator	8
2.4Waste Heat Recovery	8
2.5. Benefits of Waste Heat Recovery	9
2.5.1 Direct Benefits:.....	9
2.5.2. Indirect Benefits:	9
2.5.3. Classification of Heat Exchangers (TEMA).....	10
2.5.4. Fixed tube-sheet exchanger (non-removable tube bundle):	10
2.5.5 Removable tube bundle:	11
2.5.6. Factors Affecting Waste Heat Recovery	12
2.5.7. Waste Stream Composition	13
CHAPTER THREE	14

3. Materials and Methodology	14
3.1. Study area description	14
3.2 Data Collection.....	15
3.3. Daily Waste Generation from JURH	15
3.4. Data analysis	16
3.5. Materials and Instruments	16
3.6. System Description	18
3.6.1. Dump	18
3.6.2 Incinerator (combustion)	18
3.6.3. Heat exchanger heat recovery.....	18
3.6.4. Exhaust gas cleaning:	19
3.6.5. Dry or Wet scrubbers.....	19
3.6.6. Bag house filter (cyclone separator)	19
3.6.7. Selective Non-Catalytic Reduction	19
3.6.8. Working Principle.....	19
CHAPTER FOUR.....	19
4. Analysis of Hot Water Demand.....	20
4.1. Hot Water Demand.....	20
4.2 Introduction	20
4.3 Data from Jimma University Referral Hospital	21
4.4 Determining Hot water demand of the Hospital	21
4.4.1 Hot Water Required for Kitchen	22
4.4.2 Hot Water Required for Restaurant	23
4.4.3 Hot Water Required for Laundry Service.....	23
4.4.4 Hot Water Required for Shower.....	23
4.4.5 Total Hot Water Demand of the Jimma University Referral Hospital	24
4.4.6. Hot Water Demand Distribution over the Time of the Day	25
CHAPTER FIVE	26
5. Shell and Tube Heat Exchanger Design	26
5.1. Introduction	26
5.2. Counter flow:.....	26

5.2.1. Thermal Design Considerations of shell and tube heat exchanger.....	27
5.2.2. Tube.....	27
5.2.3. Mean Temperature Difference.....	28
5.2.4. Impute Parameter for Tube Design.....	28
5.2.5. Specification.....	29
5.2.6. Properties of Fluids.....	29
5.2.7. Estimating number of tubes.....	30
5.2.8. Correction Factor.....	31
5.2.9. Tube pitch and tube-layout.....	32
5.3. Tube passes.....	33
5.3.1. Tube sheet layout (tube count).....	33
5.3.2. Shell and Shell types (passes).....	33
5.3.3. Baffles.....	33
5.3.4. Fouling Considerations.....	34
5.3.5. Selection of fluids for tube and shell side.....	34
5.3.6. Shell and header nozzles (branches).....	35
5.3.7. Tube-Side Coefficient and Pressure Drop.....	35
5.3.8. Tube-side pressure drop.....	36
5.3.9. Shell-side coefficient.....	36
5.4. Overall coefficient.....	37
5.4.1. Shell-Side Pressure Drop.....	37
5.4.2. Flow pattern.....	37
5.4.3. Kern's method.....	38
5.4.4. CFD Methodology and analysis.....	40
5.4.5. Governing Equations.....	40
5.4.6. Flow Calculation.....	40
5.4.7. Continuity Equation.....	40
5.4.8. Momentum Equations (Navier-Stokes Equations);.....	41
5.4.9. Energy Equation.....	41
5.5. Geometry.....	41
5.5.1 Mesh.....	42

5.5.2. Boundary Conditions.....	43
5.5.3. Measure of Convergence.....	44
5.5.4. Solution.....	44
5.5.5.Run-Calculation	44
5.5.6. The Post-processor	44
CHAPTER SIX.....	45
6. Result and Discussion.....	45
6.1. Result of Energy Assessment.....	45
6.2. Proximate Analysis and Moisture content	46
6.3. Ultimate Analysis.....	47
6.4. Calorific Value	47
6.5. CFD Result.....	48
CHAPTER SEVEN	57
7. Conclusions and Recommendation.....	57
7.1. Conclusions	57
7.2. Recommendation.....	58
References.....	59
Appendixes	63
Appendix 1.....	63

CHAPTER ONE

1. INTRODUCTION

1.1. Background

Energy conversion technologies, where waste heat recovery systems are included, have received significant attention in recent years due to reasons that include depletion of fossil fuel, increasing oil prices, changes in climatic conditions, and global warming. As energy liberated (released) from the hospital incinerator in the form of heat is “free”, once the installation costs have been met, a waste heat recovery for hot water system can reduce fuel bills and in addition, it can reduce the pollutant emission. Many services and processes in hospital need hot water for different applications such as washing and boiling medical equipment, washing clothes, for bath application, kitchen processes, etc... Low temperature hot water supply system is an energy intensive process. Mainly for hospitals, the energy consumed for hot water production system is electrical and fossil fuel energy. Global environmental pollution, human health problem, increasing cost and depletion of fossil fuel, dramatically increase current demand and future dependence of the world on electricity: leads the world to seek an efficient, effective, environmental friendly and more sustainable energy [5, 10]. This research “waste heat recovery System for Hot Water Supply to Jimma university referral hospital” is aimed at the development of low temperature hot water supply systems for the hot water demand of Jimma university referral hospital focusing on energy recovery from waste heat coming from incinerator. In this research, the potential of waste heat recovery system to provide low temperature process hot water to the hospital will be investigated. The typical issues generated by applying waste heat energy for hot water supply system in hospital building will be discussed.

In the case of hospitals, one of the possible methods of heat economy could be the recovery of waste heat resulting from the incineration of wastes (this incineration being mandatory due to hygienic reasons).

In the present text, the economic feasibility of such waste heat recovery is shown, being in the order of 60% of the economies resulting when such gas is used to heat water. The development of the energy crisis has increased through each year, the trend of the need to recover energy, namely in the building sector, where such recovery could show some interesting aspects.

The saving of energy in general became therefore mandatory, being the recovery of the heat from Waste heats of incineration plants of hospitals are one of the possible ways of saving energy.

The combustion gas coming out from an incinerator carries a lot of heat; a heat recovery heat exchanger can be attached to the incinerator to recover this heat before it exits to the air. The heat is then utilized for heating the feed water of the incinerator. Heat recovery heat exchanger is placed to the combustion gas passage between the exit from the incinerator and the entry to the chimney. This decreases both fuel consumption and emission.

Waste heat, in the most general sense, is the energy associated with the waste streams of air, exhaust gases, and/or liquids that leave the boundaries of a plant or building and enter the environment. It is implicit that these streams eventually mix with the atmospheric air or the groundwater and that the energy, in these streams, becomes unavailable as useful energy. The absorption of waste energy by the environment is often termed thermal pollution. In a more restricted definition, and one that will be used in this research, waste heat is that energy which is rejected from a process at a temperature high enough above the ambient temperature to permit the economic recovery of some fraction of that energy for useful purposes. [23]

1.2. Statement of the Problem

Ethiopia is one of the fastest growing countries by medical control in Africa and planned to improve medical treatment of the country [30]. Accordingly, many hospitals are launching in the country each year and the majority of newly established hospitals are using energy intensive thermal processes. Almost all of those hospitals are dependent on the electrical power supplied by EEPSCO, fuel and natural gases imported from abroad. More than 50-60% of energy is used for thermal energy application in the hospital [3]. But the country has limited capacity of power production which is around 2267MW from hydropower and wind energy resources without involving the biggest renaissance dam, of which more than 30% of the power is supplied for hospital sector and domestic use, the remaining 70% for industry sector. This shows the country uses electrical energy for the purpose of electrical thermal heating system [4]. More energy is demanded by hospital and now a day's new hospital emerges in the country. Hospital waste heat refers to energy that is generated in hospital incineration processes without being put to practical use. Sources of waste heat include hot combustion gases discharged to the atmosphere, heated products exiting incinerator processes, and heat transfer from hot equipment surfaces. Different researcher was focused on solar water heating applications, and some are done on the industries to recovering waste heat and their applications are different. For example in industry the waste heat is recovered for steam generation and solar heating is for domestic water heating purpose,

since solar energy is free, due to this it is more attractive and researchers are focused on this area. But as solar energy is free the flue gas leaving from incinerator are also free and it is feasible to recover the hot flue gas for the same purpose.

During waste incineration from hospital, in common with most waste treatments, is to treat waste so as to reduce its volume and hazard, whilst capturing (and thus concentrating) or destroying potentially harmful substances but not on ways to recover and reuse it. Incineration of waste from hospital is being mandatory due to hygienic reasons, in case combustion was carried out during this time a lot of heat in the form of flue gas is generated, but still no one is can capture this heat and it is freely released to air. Therefore this paper shows its feasibility and capability of hot flue gas from incinerator and method of recovering this waste heat to avail.

1.3. Significance of the study

The outcome of this research can potentially to lower (reduce) the dependence of Ethiopian electricity power corporation (EEPCCO) by using the waste heat liberating from hospital incinerator. The development of the energy crisis has increased the trend of the need to recover energy, namely in the building sector, where such recovery could show some interesting aspects. In the case of hospitals, one of the possible methods of heat economy could be the recovery of waste flue gas (heat) resulting from the incineration of wastes (this incineration being mandatory due to hygienic or sanitary reasons). Heat recovery technologies frequently reduce the operating costs for facilities by increasing their energy productivity. Energy intensive industries have for many decades used waste heat recovery systems for either energy reuse or storage. The wasted heat is transferred into an energy conversion system using different types of heat recovery equipment. Once the requirements are achieved, suitable strategies have to be made to stabilize short- term energy saving and or/ energy recovery in systems using permanent solutions for implementation. These permanent solutions are commonly termed heat recovery systems. In our country Ethiopia this type of waste heat recovery is not conventional, but some papers deal about the recovery of waste heat especially from sugar factory for increasing boilers efficiency. There for in this paper introducing waste heat recovery from incinerator by design a heat exchanger to heat water for Jimma university referral hospital. Finally recovering waste heat from hospital incinerator for the purpose of water heating via heat exchanger is feasible.

1.4. Objectives

1.4.1 General Objective

The general objective of this study is to design and CFD simulation of Waste heat recovery heat exchanger from incinerator for the purpose of water heater. (A Case Study of Jimma University Referral Hospital)

1.4.2 Specific objective

- Determining the hot water demand and energy consume for water heater.
- Determine the energy value of a typical municipal solid waste by using bomb calorimeter device.
- Recovering the heat liberating from the hospital waste incineration by designing heat exchanger for water heater.

1.5. Scope of the study

This research study was conducted in Jimma university referral hospital to recover waste heat energy liberating from the incinerator in the form of flue gas for water heater. It requires a wide scale study on different part of the incinerator and environmental pollution in the form of exhaust gas from the chimney. But, with the available time and resource in order to make the study more manageable the scope is delimited to analysis of hot water demand and Experimental analysis of the typical composition of medical waste with its calorific value (energy) content, proximate and ultimate analysis of the waste and finally recovering waste heat from incinerator using shell and tube heat exchanger.

CHAPTER TWO

2. Literature Review

Researchers have been investigating the potential of WHR systems to improve boiler efficiency for over 100 years. This literature review will provide an overview of the relevant work in this field and concentrate specifically on the recovery of waste heat from hospital incinerator by using a shell and tube heat exchanger.

2.1 The overview of recovering waste heat from hospital incinerator

In many developing countries, uncontrolled dumping is often used for the disposal of solid wastes. These dumps are frequently allowed to burn - either deliberately, as a means of volume reduction, or accidentally. Typical materials found in the waste which contribute to harmful emissions include certain plastics, batteries, paints, domestic chemicals, pharmaceuticals and many industrial wastes, which pose environmental hazards. However, the internationally accepted waste hierarchy recommends minimization and prevention, re-use, recycling and composting as superior to energy recovery, direct incineration and land filling techniques [1, 6]. In large cities, mass burning of urban wastes leading to the generation of electricity is possible. However, about 100,000 tons of MSW is required to generate 7MW of electricity, which is enough for 10,000 inhabitants on the average [7]. The most common method of waste management in schools and urban areas is still incineration and land filling techniques.

Municipal solid waste s defined to include refuse from households, on-hazardous solid waste from industrial, commercial and institutional establishments (including hospitals), market waste, yard waste and street sweepings [8].

The Performance improvement of a boiler through a waste heat recovery from an air conditioning unit is described. In this study the heat from the air conditioning unit of the boiler is used for heating the feed water in boiler. The results of the study concluded that efficiency of Boiler will increase from 76.33% to 76.53% [9].

The analytical study on the waste heat recovery from Combined Ejector and Vapor Compression Refrigeration System is explained. [2].The key advantage of the combined plant is the Financial and economic aspects also justify the heat recovery as in most of the cases as in most of the cases returns in term of savings are much greater than the investment costs.

The research work on the power generation from the waste heat extracted through clinker production in the cement industry [11]. This study includes the power generation calculation for a cement plant and the different methodologies (cycles) used to generate power. Waste heat power generation has a wide scope in future to reduce carbon emissions and to optimize resources as well as energy savings.

The waste heat recovery steam generator in sponge iron plant, the waste heat in plant is utilized gas cooler [12]. The results of the study concluded that around annual savings. The research work on the efficient way to generate captive power through Waste Heat Recovery (WHR) to meet out of the needs of Iron and Steel Industries has been discussed [13]. Captive power plants have reported that the generation costs competitive with grid power.

The case study on the waste energy utilization in industries at China [14] has carried out the analysis on the different industrial processes and finding out huge data for used of organic waste again in the industries. The conclusion of the study shows that reusing the potential wastes for the production is feasible.

Apu Roy, D.H.Das has been carried out with a view to predicting the performance of a shell and finned tube heat exchanger in the light of waste heat recovery application. The performance of the heat exchanger has been evaluated by using the CFD package fluent and the available values are compared with experimental values. By considering different heat transfer fluids the performance of the above heat exchanger can also be predict. The performance parameters of heat exchanger such as effectiveness, overall heat transfer coefficient, energy extraction rate [28]

Alok Vyas, Prashant Sharma discussed about tubular heat exchanger there are several thermal design factors that are to be taken into account when designing the tubes in the tubular heat exchangers. They are tube diameter, tube length; number of tubes, number of baffles & baffles inclination etc. The characteristics of flow and heat transfer within the shell are not simple. This paper conducted various experimental analyses to predict the characteristics of difference in temperature and pressure drop, which are the performances of heat exchanger. In this study, the diameter of tube, the number of tubes and the number of baffles are considered as the design factors. Also, factors that affect the performances of heat exchanger were selected through design of experiment procedures. The purpose of this paper is how to improve the performance of tubular heat exchangers [29]. Generally, sustainability, safety, innovation, and energy conservation have recently become the most attractive and significant goals especially in modern

societies. According to Senda [15], energy conservation coupled with waste heat recovery has become an attractive topic for research in industrialized countries since the beginning of the twenty first century.

Proper management of solid waste from hospital provides benefits to the environment, quality of life of people living in the urban areas and generates employment and income. The principle of sustainable waste management strategies is thus to minimize waste generation, maximize waste recycling and reuse and ensure the safe and environmentally sound disposal of waste.

Incineration of municipal solid waste in Denmark started in 1903 in a densely populated municipality with little access to space for landfill. The energy was used for a district heating system established at the same time and for generation for the local grid. The plant also contained two coal-fired steam boilers. It was built opposite to the new municipal hospital with supply of central heat for the hospital and electricity for the local grid. A new technology – 'rotary kiln' instead of 'batch firing' was introduced in 1931 and followed by a few other plants including a replacement of the first plant from 1903. The waste was collected by horse-driven wagons. Following a contemporary description of the process:

The body of the wagon is tipped so that the waste is emptied into the waste pit ... Absolutely nobody gets into physical contact with the waste. The waste is temporarily stored and subsequently transported by conveyors to taking the waste to a chute that leads to the drying grate of the furnace or incinerator. Then the waste followed to an ignition grate or incinerator. The incineration products have an average temperature of approximately 1000°C in the flue gas chamber after the rotary kiln. The heat contained in the incineration products is recovered in a Babcock & Wilcox high-pressure boiler. The rotary kiln system generates very little fly ash – only approximately 2 per cent of the amount of waste incinerated in order to be able to perform a complete cleaning of the flue gas both the boiler and the economizer are equipped with 'soot pockets' ... and after the economizer a special flue gas cleaner capturing approximately 80 per cent of the fly ash has been established so that the flue gas, when emitted from the stack of the incineration plant, is light and free of solid matter.

In each of the three plants there were two units with achieved capacities up to 10 tons per hour. The steam pressure was different – from 16 to 30 bars – with steam temperatures between 190° and 425° C. The steam production was 0.9-1.0 kg steam per 1 kg waste. Economic growth has led to expansion of building sectors, increasing building energy consumption in the process.

About 48% of consumable energy was utilized by the residential and commercial sector of the U.S. in 2014 [16]. Most of this energy is used for space heating, water heating, and air conditioning. In 2009, The U.S. Energy Information Administration stated that these needs consume 65% of energy use in residences [17]. The remaining 35% was expended by appliances, electronics, and lighting. Increased energy costs and concerns with environmental impacts drive continued efforts to improve end-use energy efficiency. Waste heat recovery may be an important part of these efforts to reduce primary energy consumption.

2.2. Research gap

In this literature a brief description of waste heat recovery from different industries, institutions and commercials are detail explained but still know there is no waste heat recovers from Jimma University Referral hospital incinerator. Due to this there is much energy in the form of heat and costs should be lost, and in this research I had make recovering waste heat in the incinerator to reduce cost and save energy.

2.3 Basics of the combustion process in the hospital waste incinerator

Basically, waste incineration is the oxidation of the combustible materials contained in the waste. Waste is generally a highly heterogeneous material, consisting essentially of organic substances, minerals, metals and water. During incineration, flue-gases are created containing the majority of the available fuel energy as heat. Burning of organic fuel substances occurs ones they have reached the necessary ignition temperature and came into contact with oxygen. The combustion process takes place in the gas phase, in fractions of seconds, and simultaneously releases energy where the calorific value of the waste and oxygen supply is sufficient. This can lead to a thermal chain reaction and self-supporting combustion, i.e. there is no need for the addition of other fuels.

2.4Waste Heat Recovery

Waste heat losses arise both from equipment inefficiencies and from thermodynamic limitations on equipment and processes. For example, consider oil fired furnaces frequently used in steel melting operations. Exhaust gases immediately leaving the furnace can have temperatures as high as 2200-2400°F [200-300°C]. Consequently, these gases have high heat content, carrying away as much as 60% of furnace energy inputs. Efforts can be made to design more energy efficient reverberatory furnaces with better heat transfer and lower exhaust temperatures;

however, the laws of thermodynamics place a lower limit on the temperature of exhaust gases. Since heat exchange involves energy transfer from a high temperature source to a lower temperature sink, the combustion gas temperature must always exceed the molten steel temperature in order to facilitate steel melting. The gas temperature in the furnace will never decrease below the temperature of the molten steel, since this would violate the second law of thermodynamics. Therefore, the minimum possible temperature of combustion gases immediately exiting a steel reverberatory furnace corresponds to the aluminum pouring point temperature 1200-1380°F [650-750°C]. In this scenario, at least 40% of the energy input to the furnace is still lost as waste heat. [25]

2.5. Benefits of Waste Heat Recovery

Benefits of 'waste heat recovery' can be broadly classified in two categories:

2.5.1 Direct Benefits:

All waste heat that is successfully recovered directly substitutes for purchased energy and Recovery of waste heat has a direct effect on the efficiency of the process. This is reflected by reduction in the utility consumption & costs, and process cost.

2.5.2. Indirect Benefits:

a) **Reduction in pollution:** A number of toxic combustible wastes such as carbon monoxide gas, sour gas, carbon black off gases, oil sludge, and other plastic chemicals etc., releasing to atmosphere if/when burnt in the incinerators serves dual purpose i.e. recovers heat and reduces the environmental pollution levels, and the cost of operation may be significantly reduced through waste-heat recovery from the incinerator exhaust gases. Finally, in every case of waste-heat recovery, a gratuitous benefit is derived: that of reducing thermal pollution of the environment by an amount exactly equal to the energy recovered, at no direct cost to the recovered.

b) **Reduction in equipment sizes:** Waste heat recovery reduces the fuel consumption, which leads to reduction in the flue gas produced. This results in reduction in equipment sizes of all flue gas handling equipment such as fans, stacks, ducts, burners, etc.

c) **Reduction in auxiliary energy consumption:** Reduction in equipment sizes gives additional benefits in the form of reduction in auxiliary energy consumption like electricity for fans, pumps etc...

2.5.3. Classification of Heat Exchangers (TEMA)

Amongst of all type of exchangers, shell and tube exchangers are most commonly used heat exchange equipment. Some Classification of heat exchanger is shown in Figure below [24].

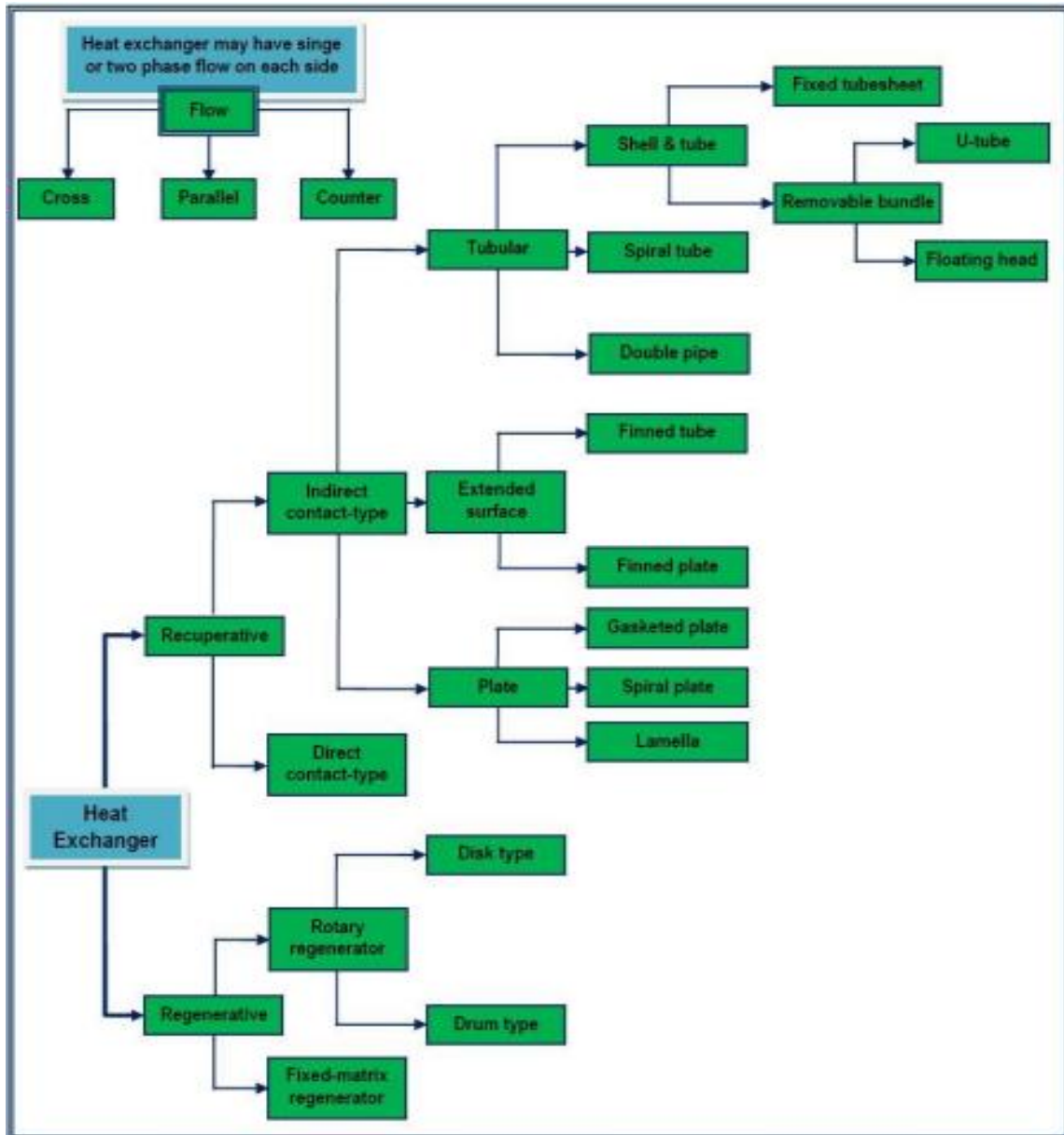

Figure2. 1 Classification of heat exchangers depending on their applications

2.5.4. Fixed tube-sheet exchanger (non-removable tube bundle):

The simplest and cheapest type of shell and tube exchanger is with fixed tube sheet design. In this type of exchangers the tube sheet is welded to the shell and no relative movement between the shell and tube bundle is possible.

2.5.5 Removable tube bundle:

Tube bundle may be removed for ease of cleaning and replacement. Removable tube bundle exchangers further can be categorized in floating-head and U-tube exchanger.

The different operational and constructional advantages and limitations depending on applications of shell and tube exchangers are summarized in Table. TEMA and IS: 4503-1967 (India) standards provide the guidelines for the mechanical design of unfired shell and tube heat exchangers. As shown in the Table, TEMA 3-digit codes specify the types of front-end, shell, and rear-end of shell and tube exchangers.

Table2. 1 Features of shell and tube type exchanger [26]

<i>Shell and Tube Exchangers</i>	<i>Typical TEMA code</i>	<i>Advantages</i>	<i>Limitations</i>
Fixed tube sheet	BEM, AEM, NEN	Provides maximum heat transfer area for a given shell and tube diameter. Provides for single and multiple tube passes to assure proper velocity. Less costly than removable bundle designs.	Shell side / outside of the tubes are inaccessible for mechanical cleaning. No provision to allow for differential thermal expansion developed between the tube and the shell side. This can be taken care by providing expansion joint on the shell side.
Floating-head	AEW, BEW, BEP, AEP, AES, BES	Floating tube sheet allows for differential thermal expansion between the shell and the tube bundle. Both the tube bundle and the shell	To provide the floating-head cover it is necessary to bolt it to the tube sheet. The bolt circle requires the use of space where it would be possible to place a large

		side can be inspected and cleaned mechanically.	number of tubes. Tubes cannot expand independently so that huge thermal shock applications should be avoided. Packing materials produce limits on design pressure and temperature.
U-tube	BEU, AEU	U-tube design allows for differential thermal expansion between the shell and the tube bundle as well as for individual tubes. Both the tube bundle and the shell side can be inspected and cleaned mechanically. Less costly than floating head or packed floating head designs.	Because of U-bend some tubes are omitted at the Centre of the tube bundle. Because of U-bend, tubes can be cleaned only by chemical methods. Due to U-tube nesting, individual tube is difficult to replace. No single tube pass or true countercurrent flow is possible. Tube wall thickness at the U-bend is thinner than at straight portion of the tubes. Draining of tube circuit is difficult when positioned with the vertical position with the head side upward.

2.5.6. Factors Affecting Waste Heat Recovery

Evaluating the feasibility of waste heat recovery requires characterizing the waste heat source and the stream to which the heat will be transferred. Important waste stream parameters that must be determined include: These parameters allow for analysis of the quality and quantity of the

stream and also provide insight into possible materials/design limitations. For example, corrosion of heat transfer media is of considerable concern in waste heat recovery, even when the quality and quantity of the stream is acceptable.

2.5.7. Heat Quantity

The quantity, or heat content, is a measure of how much energy is contained in a waste heat stream, while quality is a measure of the usefulness of the waste heat. The quantity of waste heat contained in a waste stream is a function of both the temperature and the mass flow rate of the stream.

2.5.8. Waste Heat Temperature Quality

The waste heat temperature is a key factor determining waste heat recovery feasibility. Waste Heat temperatures can vary significantly, with cooling water returns having low temperatures around 100- 200°F [40 -90°C] and glass melting furnaces having flue temperatures above 2,400°F [1,320°C]. In order to enable heat transfer and recovery, it is necessary that the waste heat source temperature is higher than the heat sink temperature. Moreover, the magnitude of the temperature difference between the heat source and sink is an important determinant of waste heat's utility or "quality".

2.5.9. Waste Stream Composition

Although chemical compositions do not directly influence the quality or quantity of the available heat (unless it has some fuel value), the composition of the stream affects the recovery process and material selection. The composition and phase of waste heat streams will determine factors such as thermal conductivity and heat capacity, which will impact heat exchanger effectiveness. Meanwhile, the process specific chemical makeup of off gases will have an important impact on heat exchanger designs, material constraints, and costs.

2.6. Minimum Allowable Temperature

The minimum allowable temperature for waste streams is often closely connected with material corrosion problems. Minimum exhaust temperatures may also be constrained by process related chemicals in the exhaust stream; for example, sulphates in exhaust gases from glass melting furnaces will deposit on heat exchanger surfaces at temperatures below about 510°F [270°C].

CHAPTER THREE

3. Materials and Methodology

3.1. Study area description

Jimma is located on 343km by road southwest of Addis Ababa. Its geographical coordinates are approximately $7^{\circ}40'N$ latitude and $36^{\circ}50'E$ longitude. The town is found in an area of average altitude, of about 5600 ft. (1700 m) above sea level. It lies in the climatic zone locally known as Woynā Dagā. Jimma is generally characterized by warm climate with daily mean temperature staying between $20^{\circ}c$ and $25^{\circ}c$. To establish safe, attractive and pleasant areas in which to live with development being of a nature which maintains the desired characteristic of the specific zones.



Figure 3. 1 map of study area

Source: Google

3.2 Data Collection

This research study was conducted following the review of relevant literatures and interviews were prepared and used for data collection, training of groups of data collectors, measurement of collected samples, hospitals daily waste generation and waste classification by type and sorting was done.

In the process devoted to collecting information about the waste heat recovery from hospital incinerator regarding available components, systems, problems and related studies. The general objective of the study is design and simulating of waste heat recovery heat exchanger for hospital incinerator. To achieve this objective quantitative methods are employed. In order to collect quantitative information at the hospital incinerator, observation and measurement method employ as alternative technique of obtaining information on the subject matter.

The waste from hospital is collected by using different color plastic bag in the hospitals distributed to rooms, colliders and beds for seven days continuously. After the waste collection, sorting of waste into different components was made for each plastic bag on each day then measuring the total weight of each collected wastes had be done. In this study there is some assumption was taken to the waste next to sorting shredded of all waste and drying the waste to get complete combustion and reduce moisture content to increase heating value. Since weekly working days is specified as three days and the collected waste should dried before dumped to incinerator, this gap was assumed in order to take enough time for drying the waste.

3.3. Daily Waste Generation from JURH

During the study period, the estimated daily waste generation rate at JURH was over 1189.5kg/day, which consisted of plastic including PVC, syringe, pharmaceutical, PET and all hard and soft plastics and Textiles, including swabs, garments, pads, absorbent, beddings and papers cardboard and woods are recorded. The JURH waste consisted of 98.02% combustible wastes and 1.98% noncombustible wastes by mass. The combustible wastes constituted paper (24.63%), textiles (19.94%), wood, and garden trimming (3.00%), and plastics (50.45%). The noncombustible waste which includes needles and sharp of 0.92% metal and 1.06% glass are recorded during measuring of waste generation per day.

table3. 1 typical waste generation from JURH

Type	Generation rate in %
Plastic(including, pharmaceutical, hard and soft plastic)	50.45
Textiles (including, garments, facial matter, bedding....)	19.94
Papers, cardboard	24.63
Wood(garden trimming)	3

It is considered possible to recover 60% of the energy produced in the incinerator with adequate heat exchanger. The hospital has considered as the total of 1500 beds; the hospital garbage has the following average characteristics:

Since all the wastes have heterogeneous and have different calorific value but taking its average value of heat capacity (calorific value) as of Ethiopian geological survey lab is 22.36MJ/kg.

The hospital has a total number of beds---1500; from this bed only 10 are select for the sample to measure daily waste for seven days consecutively.

An average Production of garbage (waste)-----0.793kg/bed/day and the total waste per day is $1500 \text{ bed} * 0.793 \text{ kg} = 1189.5 \text{ kg}$.

Temperature of cold water from main (considering at room temperature) ---20°C;

Temperature of hot water to use-----80°C

From the above data the total heating value is determined by multiplying the estimated waste per day by the average heating value and thus $1189.5 \text{ kg} * 22.36 \text{ MJ/kg} = 26596.6 \text{ MJ}$, therefore, the heat recovered allows for an economy of 60% of the conventional energy used for heating the water.

3.4. Data analysis

In the data analysis the compositions of waste was analyzed and waste generation rate and per bed generation rate were determined.

3.5. Materials and Instruments

During the study time the following listed materials and equipment were used.

1. Hand protective plastic gloves;

- To protect hand from direct contact with dirt.

2. Mouth & Nose Mask;

- To protect one from bad smells and inhalation of any fumes.

3. Balance scale

- For weight measurement of collected sample waste

4. Plastic sheets

- To ensure no loss of waste during sorting

5. Different type and color plastic bags

- For the collection of waste from each collider, room and beds

6. Garbage bags

- For handling the collection of plastic bags

7. Bomb calorimeter

- For the determination of heating value

8. Digital and non-digital oven

- For proximate analysis (including moisture content, VCM and ash content)

9. Solid waste from hospitals, incinerators and computer lab for design and simulation of waste heat recovery heat exchanger system by ANSYS software.

3.6. System Description

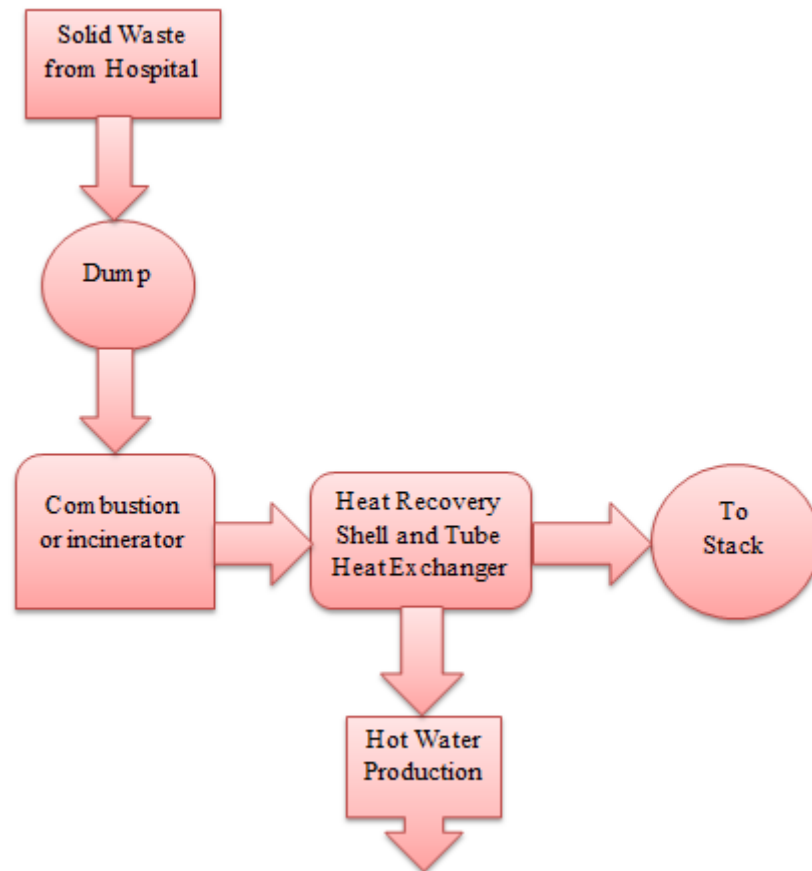

Figure3. 2 waste heat recovery flow diagram

3.6.1. Dump

The collected material is located in a land site and from here taken to be sent to the incineration process.

3.6.2 Incinerator (combustion)

Incineration is the treatment of waste material by combustion of organic substances present in the waste materials. It converts the waste material into heat, flue gas and ash which are released into the atmosphere without any further treatment for usage.

3.6.3. Heat exchanger heat recovery

The gas coming from the combustion process at a temperature around 150°C to 250°C is sent to a heat exchanger for transfer of its heat from hot fluids in tubes to a cold fluids in shell then used in hot water production. Out of the exchanger, at a temperature around 80°C to 120°C, the gas is

then sent to the gas cleaning line to abate the polluting substances (dust, acid gas, etc.), and is discharged from the chimney into the atmosphere.

3.6.4. Exhaust gas cleaning: The exhaust gas from the boiler is typically cleaned by the following advanced pollution control systems to ensure compliance with the stringent environmental standard.

3.6.5. Dry or Wet scrubbers

To spray lime powder or fine atomized slurry into the hot exhaust gas to neutralize and remove the polluted acidic gases (sulphur oxides, hydrogen chloride).

3.6.6. Bag house filter (cyclone separator)

Filter and remove dust and fine particulates.

3.6.7. Selective Non-Catalytic Reduction

Remove a nitrogen oxide (which is a cause of urban smog) by reacting them with ammonia or urea. [20]

3.6.8. Working Principle

The combustion flue gas coming out from an incinerator carries a lot of heat; around 150°C to 250°C. Heat exchanger can be attached to the incinerator to recover this heat before it exits to the air, (i.e.) between the exit from the incinerator and the entry to the chimney. This temperature sent to a heat exchanger for transfer of its heat from hot fluids to a cold fluid then used to produce hot water.

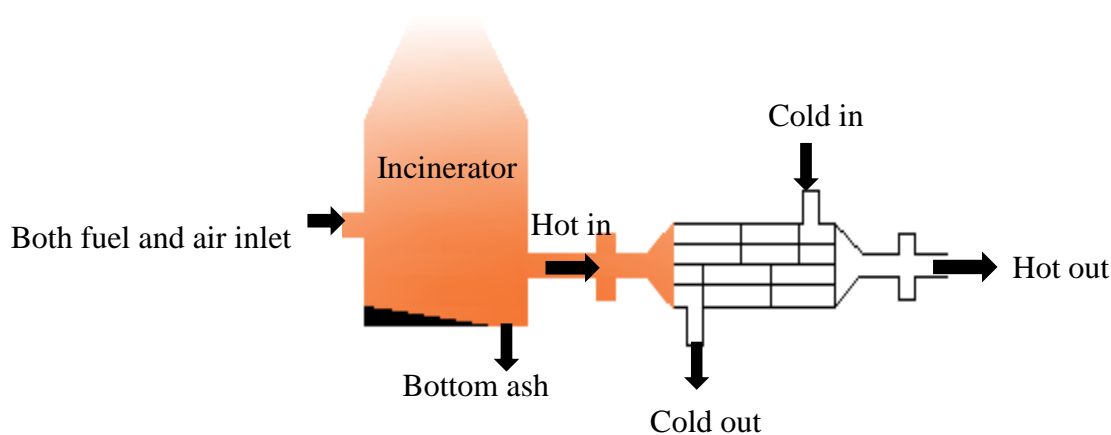

Figure3. 3 working principle of shell and tube heat exchanger

CHAPTER FOUR

4. Analysis of Hot Water Demand

4.1. Hot Water Demand

4.2 Introduction

Hospitals and health care buildings traditionally have high energy demands for both mechanical power and heat. Heat is required for space heating needs, sanitary hot water, and steam production. Among the heat required system of the hospital, water heating (hot water) and space heating system is one of the most energy extensive processes. Demand for Hot water consumption in hospital is very high. Also, because of the big size of the buildings, there is important loss of heat in the pipeline [3].

That's why the needs in hot water must be determined with accuracy, since they differ from one hospital to another, in order to avoid unnecessary energy consumption for water heating. To reduce energy use and greenhouse gas emissions by hospital facilities, the health care sector needs energy efficient solutions operating at the lowest cost and free from environment pollution gas emission. Generally almost all hospitals in the world require water for different appliance that Depending on the type and size of a facility, hospitals typically use 15% of their water for non-domestic use (sterile processing and radiology) and 85% for domestic use including (boilers, chillers, food services to the patient and pantry service for guests, operating rooms, laundry facilities, kitchen equipment, sinks, tubs and showers, washing basing and toilets). Daily water demand of the hospital about 90% is hot water and 10% is cold water application [3]. In Ethiopia most of hospitals requires hot water for the appliance including kitchen equipment washing, laundry facilities, showering purpose, food service to the patient and hospital restaurants, sterile processing, boilers and radiology. Few private hospitals have higher standard, which riches to the typical standard hospital hot water demand and appliance used.

This chapter manly concentrates on hot water demand calculation of Jimma University Referral hospital. This hospital uses electricity as sources of energy for water heating, to meet daily hot water demand of the hospital. The appliance considered for this study includes kitchen equipment, laundry facilities, shower and restaurant of JUR hospital new building.

4.3 Data from Jimma University Referral Hospital

In developing countries such as Ethiopia, due to absence or malfunction of measuring instruments and misinformation about hospital hot water system, reliable data of the hospital is not found. In the absence and scarcity of reliable hot water system of the hospital data, assumption and estimation are made based on the standard hot water delivery system of hospital. Data gathered methods are inspection (the hospital building) and interview (the workers of the hospital).

Table4. 1 Data from JUR Hospital

Parameters	Appliance					
	Kitchen	Shower			Restaurant	Laundry
		Patient1	Patient2	Medicalstuff3		
Number of room	2	2	2	3	2	1
Person per room	10	12	8	4	10	3

4.4 Determining Hot water demand of the Hospital

The hot water demand is decisive for the dimensioning of a domestic hot water recovering waste heat from incineration system (DHWRIS). However, this depends on the users' habits. For example, if a person is used to have a shower rather than a bath, the daily hot water demand is significantly lower than if a bath is frequently taken. For developed countries, it is better to assume that the daily hot water requirement for based on the developed countries requirement.

Table4. 2 Standard Hot Water Demand for Hospital

Demand	Standard hot water demand for different uses			
	Kitchen	Shower	Restaurant	Laundry
Hot water	320L/kitchen	60L/person	160L/restaurant	530L/laundry
Temperature	48°C	43 °c	48 °c	60 °c

For this study; determination of the hospital hot water demand per day; is performed by make assumptions. Depending on Ethiopian condition it is good to assume that the daily hot water requirement for shower will be determined by multiplying the developed countries hot water

requirement for shower by the ratio (1:2). Final hot water demand for each appliance is listed in table below.

Table4. 3 Hot Water Demand for each Appliance of the Hospital

Demand	Appliance of the hospital			
	Kitchen	Shower	Restaurant	Laundry
Hot water(L/day)	320L/day/kitchen	30L/day/person	260L/day/restaurant	35L/day/laundry
Temperature(°c)	50	45	50	65-75
Energy source	Electrical	Electrical	Electrical	Electrical

Determination of hot water demand of Jimma university referral hospital for different appliance is done by considering only hot water needs of hospitals. There is one hot water consumption systems in the hospital that is the daily hot water consumption system, used for determination of waste heat recovery for water heating system and the heat transfer area.

Hot water demand for each appliance is given by:

$$H_{WD} = \text{Number of Room} \times \text{water per appliance} \dots\dots\dots \text{Eqn.4.1}$$

Hot water demand for showering service is given by;

$$HWDS = (\text{number of room}) \times \left(\frac{\text{person}}{\text{room}}\right) \times \left(\frac{\text{water}}{\text{person}}\right) \dots\dots\dots \text{Eqn.4.2}$$

Total daily hot water demand of Jimma university referral hospital is determined as:

$$TDHWD = HWDS + HWDR + HWDL + HWDK \dots\dots\dots \text{Eqn.4.3}$$

4.4.1 Hot Water Required for Kitchen

In the kitchen hot water is required for cooking equipment washing and shower service for cookers.

By applying equation (4.1), daily hot water demand for the kitchen is:

$$HWDK = 2 \times 320L = 640 \text{ liter per day}$$

4.4.2 Hot Water Required for Restaurant

For the hospital restaurant hot water is required for cooking and cafe equipment washing and shower service for restaurant servant.

Hot water demand of the restaurant is determined by applying equation (4.1):

$$HWDR = 2 \times 260L = 520 \text{ liter per day}$$

4.4.3 Hot Water Required for Laundry Service

Hot water is required for laundry service of the hospital is for cloth washing and shower service of workers in the room.

Hot water demand for laundry service is determined by applying equation (4.1):

$$HWDL = 1 \times 210L = 210 \text{ liter per day}$$

4.4.4 Hot Water Required for Shower

Shower service is required for the patients, workers and medical staffs of the hospital. Based on the rate of occupancy shower service is divided in to four and hot water demand for shower service is determined by using equation (4.2).

Shower service for kitchen worker is:

$$HWDK_w = 2 \times 10 \times 45 = 900 \text{ liter per day}$$

Shower service for patient 1 is

$$HWDs_1 = 2 \times 12 \times 45 = 1080 \text{ liter per day}$$

Shower service for patient 2 is

$$HWDs_2 = 2 \times 8 \times 45 = 720 \text{ liter per day}$$

Shower service for medical staff is

$$HWDs_3 = 3 \times 4 \times 45 = 540 \text{ liter per day}$$

Shower service for restaurant worker is

$$HWDR_s = 2 \times 10 \times 45 = 900 \text{ liter per day}$$

Shower service for laundry workers is

$$HWDL = 1 \times 3 \times 45 = 135 \text{ liter per day}$$

Total daily hot water demand for shower service is determined by using equation (4.3):

$$THWDS = HWDK_w + HWDs1 + HWDs2 + HWDs3 + HWDR_s + HWDL$$

$$THWDS = 900 + 1080 + 720 + 540 + 900 + 135 = 4275 \text{ liter per day}$$

4.4.5 Total Hot Water Demand of the Jimma University Referral Hospital

Therefore, the total amount of hot water demand of the hospital is (THWD):

$$THWD = HWDK + HWDR + HWDL + THWDS$$

$$THWD = 640 + 520 + 210 + 4275 = 5645 \text{ liter per day}$$

Table 4. 4 Hot water demand of the Jimma Hospital per Services

Demand	Service				Total
	Kitchen	Shower	Restaurant	Laundry	
Hot water L/day	640	4275	520	210	5645L/day

The daily and weekly hot water consumption of the hospital can be increase or decrease from the calculated value, so to compensate the error created the calculated value can be multiplied by same factor 1.25. The factor is one fourth of the total calculated daily and weekly hot water demand of the hospital [18].

Total hot water should be supplied (THWS) is:

$$THWS = (\text{Daily Hot Water consumption liter per day}) \times 1.25 \text{-----Eqn.4.4}$$

Table 4. 5 Total Hot water demand of the Hospital per Services

Demand	Service				Total
	Kitchen	Shower	Restaurant	Laundry	
Hot water L/day	800	5343.75	650	262.5	7431.25L/day

The variation of total daily hot water demand of each appliance is shown by the figure below.

Daily Hot Water Demand for each Appliance

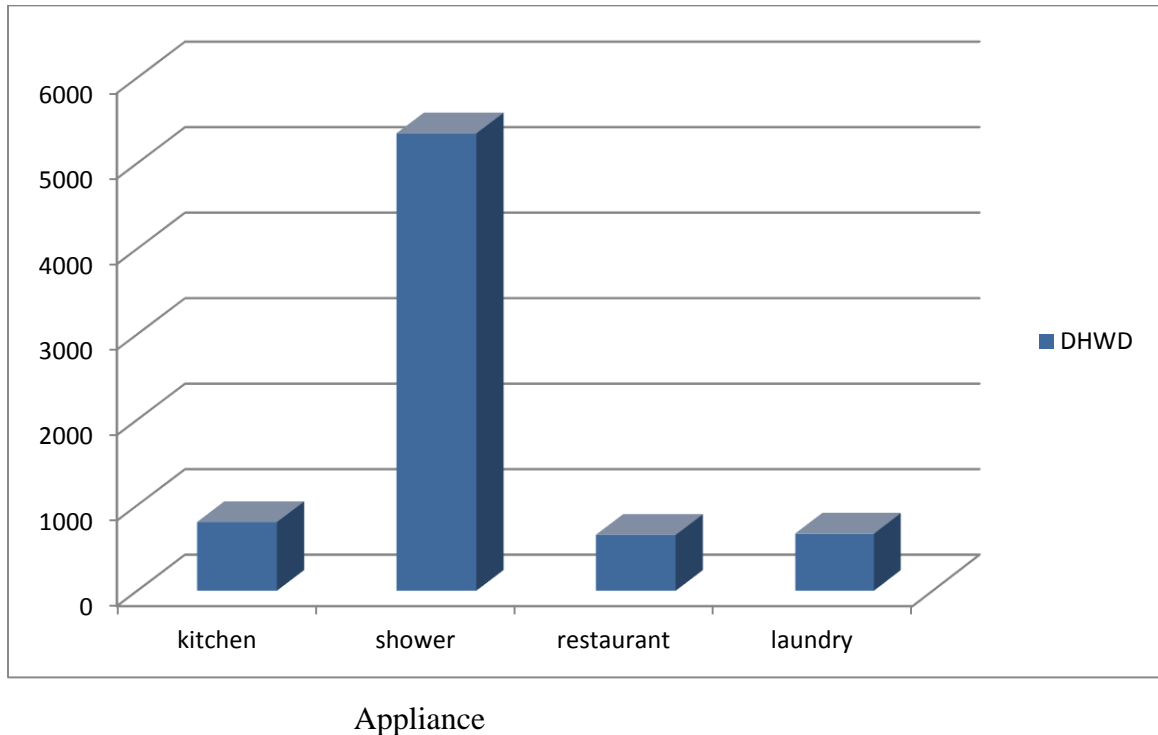

Figure4. 1 Daily Hot Water Demand of each Appliance

4.4.6. Hot Water Demand Distribution over the Time of the Day

Daily hot water requirement for Jimma university referral hospital will be 7431.25 liter per day. This daily hot water consumption can be distributed as 60% in the morning, 10% at the mid-day and the rest 30% will be distributed in the evening time.

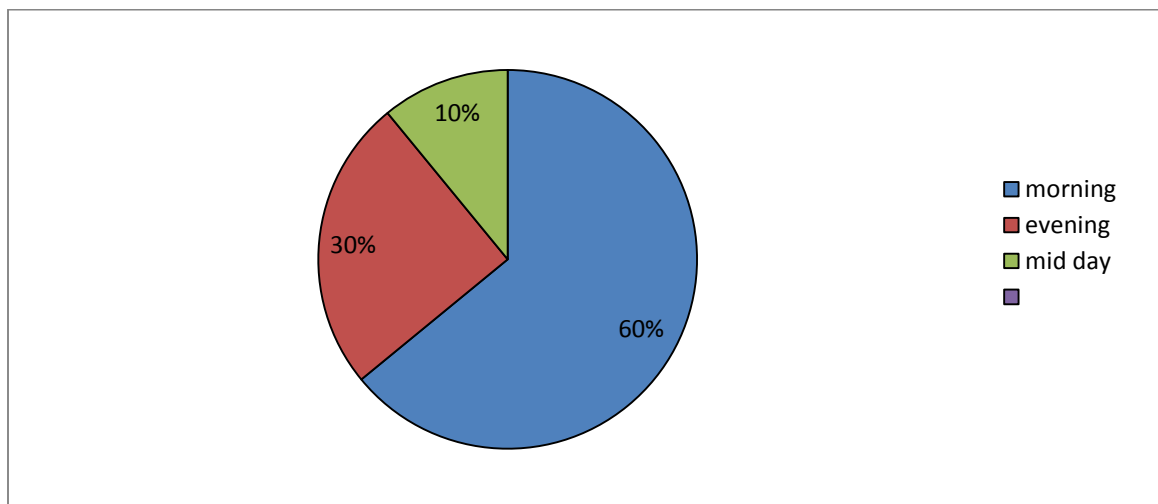

Figure 4. 2.Hot Water Demand Distribution over the Time of the Day

CHAPTER FIVE

5. Shell and Tube Heat Exchanger Design

5.1. Introduction

A heat exchanger is a heat transfer device to provide heat transfer thermal energy between two or more fluids, between a solid surface and a fluid, or between solid particulates and a fluid available, at different temperatures. In most of heat exchanger available, the fluids separated by a heat transfer surface, and in which they ideally do not mix. The shell-and-tube heat exchangers [STHE] are still the most common type in use. They have larger heat transfer surface area-to-volume ratios than the most of common types of heat exchangers, and they are manufactured easily for a large variety of sizes and flow configurations. They can operate at high pressures, and their construction facilitates disassembly for periodic maintenance and cleaning. The shell-and-tube heat exchangers consist of a bundle of tubes enclosed within a cylindrical shell. One fluid flows through the tubes and a second fluid flows within the space between the tubes and the shell. Geometry is one of the parameter which affects the performance of heat exchanger. As its name implies, this type of heat exchanger consists of a shell (a large pressure vessel) with a bundle of tubes inside it. One fluid runs through the tubes, and another fluid flows over the tubes (through the shell) to transfer heat between the two fluids.

Heat exchangers are used in the process, power, petroleum, transportation, air conditioning, refrigeration, heat recovery, alternate fuels, and other industries. Transfer of heat from one fluid to another is an important operation for most of the chemical industries. The most common application of heat transfer is in designing of heat transfer equipment for exchanging heat from one fluid to another fluid. Such devices for efficient transfer of heat are generally called Heat Exchanger. Heat exchangers are normally classified depending on the transfer process occurring in them and counter flow process is the most among them.

5.2. Counter flow:

In counter flow heat exchangers the fluids enter the exchanger from opposite ends. Counter flow heat exchangers are more efficient than parallel flow heat exchangers because they create a more a more uniform temperature difference between the fluids, over the entire length of the fluid path. Counter flow heat exchangers can allow the cold fluid to exit with a higher temperature

than the exiting hot fluid. The flow arrangement for such a heat exchanger is shown schematically in Figure below.

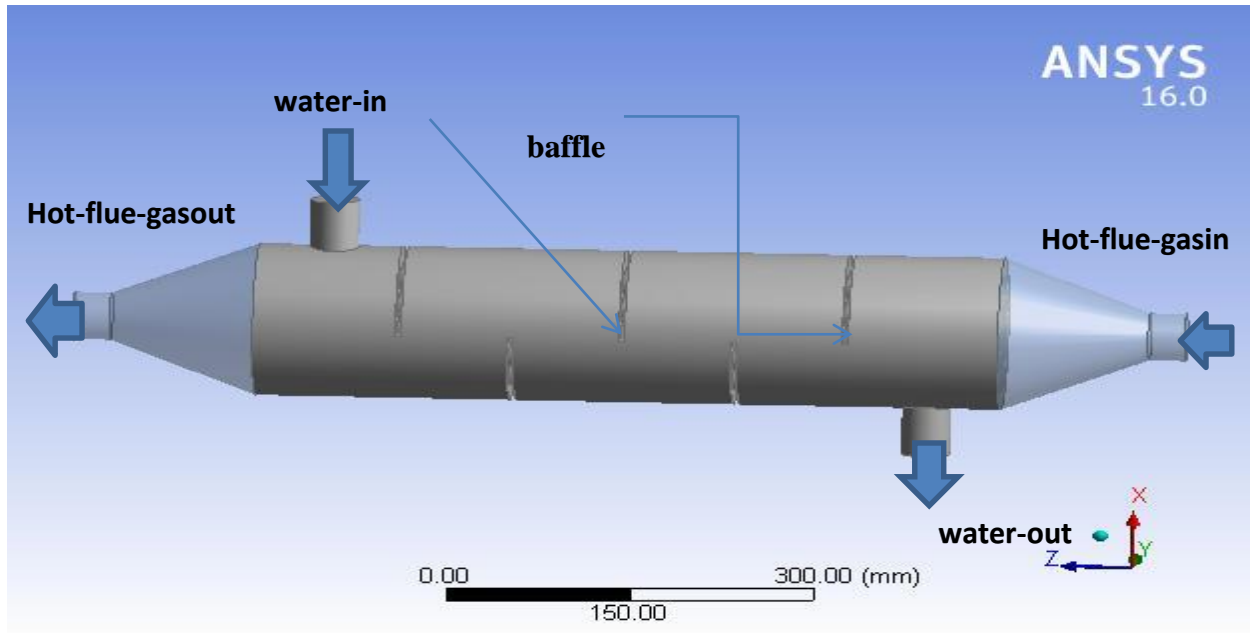

Figure5.1 Schematic of one-shell one-pass (1-1) shell-and-tube heat exchanger

5.2.1. Thermal Design Considerations of shell and tube heat exchanger

The flow rates of both hot and cold streams, and their terminal temperatures and fluid properties are the primary inputs of thermal design of heat exchangers, thus in this case the hot fluid is flue gas and the cold fluid is water with fluid flow rate of 1m/s and 1.5m/s respectively and temperature of 190°C and 25°C for the hot fluid and cold fluid respectively.

Thermal design of a shell and tube heat exchanger typically includes the determination of heat transfer area, number of tubes, tube length and diameter, tube layout, number of shell and tube passes, type of heat exchanger (fixed tube sheet, removable tube bundle etc.), tube pitch, number of baffles, its type and size, shell and tube side pressure drop etc.

5.2.2. Tube

The most efficient condition for heat transfer is to have the maximum number of tubes in the shell to increase turbulence. The tube thickness should be enough to withstand the internal pressure along with the adequate corrosion allowance. The tube thickness is expressed in terms of BWG (Birmingham Wire Gauge) and true outside diameter (OD).

5.2.3. Mean Temperature Difference

The heat transfer area required for a given duty, an estimate of the mean temperature difference ΔT_m must be made. This will normally be calculated from the terminal temperature differences: the difference in the fluid temperatures at the inlet and outlet of the exchanger. The well-known “logarithmic mean” temperature difference is only applicable to sensible heat transfer in true co-current or counter-current flow (linear temperature enthalpy curves). For counter-current flow, Figure below [26], the logarithmic mean temperature is given by: Before a heat transfer area across the surface can be used to determine the heat transfer area

$$\Delta T_{LM} = \frac{(T_1 - t_2) - (T_2 - t_1)}{\ln \frac{(T_1 - t_2)}{(T_2 - t_1)}} \dots \dots \dots Eqn. 5.1$$

Where, ΔT_m = log mean temperature difference,

T_1 = hot fluid temperature, inlet,

T_2 = hot fluid temperature, outlet,

t_1 = cold fluid temperature, inlet,

t_2 = cold fluid temperature, outlet.

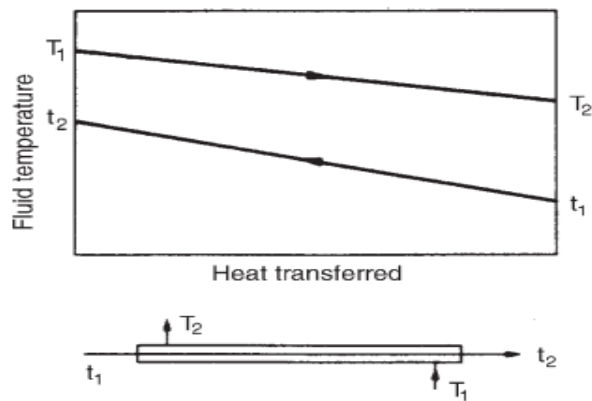

Figure 5.2 Temperature profiles of Counter-flow heat exchanger

5.2.4. Input Parameter for Tube Design

Shell Material = Steel

Tube Material = Copper

Take tube length = 8ft or 2.44m

Tube outside diameter = 20mm

Tube inside diameter = 16 and according to BWG 14 the thickness is 2.108mm

Flow rate of waste = 250kg/hr.

$$U = 50 \text{ w/m}^2\text{c, assumption}$$

5.2.5. Specification: defining the fluid temperature and specifying its temperature as cold and hot fluid.

Table 5.1 specifications of fluid properties

Parameter	Value
Hot Fluid	Flue Gas $T_{hi} = 190^\circ\text{C}$ $T_{ho} = 80^\circ\text{C}$
Cold Fluid	Water $T_{ci} = 20^\circ\text{C}$ $T_{co} = 80^\circ\text{C}$
Type of Tubes	Plain Tubes
Number of Tubes	21

5.2.6. Properties of Fluids: A fluid has certain characteristics by which its physical condition may be described. These characteristics are called properties of the fluid. Some properties of flue gas and water are listed in table below [27].

Table 5.2 fluid properties

Hot Fluid (Flue Gas)	Cold Fluid (Water)
$\rho_h = 0.788 \text{ kg/m}^3$	$\rho_c = 998 \text{ kg/m}^3$
$C_{ph} = 1.092 \text{ KJ/Kgk}$	$C_{pc} = 4.178 \text{ kj/kgk}$
$\mu_h = 23.80 \times 10^{-6} \text{ kg/ms}$	$\mu_c = 7.09 \times 10^{-6} \text{ kg/ms}$
$Pr = 0.671$	$Pr = 5.650$
$K_h = 0.03714 \text{ w/mk}$	$K_c = 0.6178 \text{ w/mk}$

5.2.7. Estimating number of tubes

Number of tubes can be calculating using the formula

$$N_t = k_1 \left(\frac{D_b}{d_o}\right)^{n_1} \dots\dots\dots \text{Eqn.5.2}$$

$$D_b = d_o \left(\frac{N_t}{k_1}\right)^{\frac{1}{n_1}} \dots\dots\dots \text{Eqn.5.3}$$

Where, N_t = number of tubes,

D_b = bundle diameter, mm,

d_o = tube outside diameter, mm assuming square pitch and for the above equation the value of constants should be taken from table below.

Table5.3 Constants for use in equation

Square pitch, $P_t = 1.25d_o$					
No. of passes	1	2	4	6	8
K_1	0.215	0.156	0.158	0.0402	0.0331
n_1	2.207	2.291	2.263	2.617	2.643
Triangular pitch, $P_t = 1.25d_o$					
No. of passes	1	2	4	6	8
K_1	0.319	0.249	0.175	0.0743	0.0365
n_1	2.142	2.207	2.285	2.499	2.675

From the first law of thermodynamics the rate of heat transfer from the hot fluid is equal to the rate of heat transfer to the cold one. That is, $(Q) = m_h C_{ph} (\Delta T)_h = m_c C_{pc} (\Delta T)_c$.

Volume flow Rate of Flue Gas for the incinerator is = $250 \text{ m}^3/\text{hr}$. To Find the Mass Flow Rate of Flue Gas;

$$m_h = \dot{V} \rho / t$$

$$m_h = 250 \times 0.788 / 3600$$

$$m_h = 0.547 \text{ kg/sec}$$

Mass Flow Rate of Cold Fluid

$$Q = m_h c_{ph} (\Delta T) h = mcCpc (\Delta T) c$$

$$Q = mhCph (Thi-Tho) = mcCpc (Tco-Tci)$$

$$0.547 \times 1.092 \times (190-80) = mc \times 4.178 \times (80-25)$$

$$\therefore mc = 0.286 \text{ kg/sec}$$

$Q = 65.7 \text{ kw}$ this is the heat transfer rate.

$$\Delta T_{lm} = \frac{(T_1 - t_2) - (T_2 - t_1)}{\ln \frac{(T_1 - t_2)}{(T_2 - t_1)}} (190 - 80) - (80 - 25) / \ln \frac{(190 - 80)}{(80 - 25)} = 79.36^\circ \text{c}$$

The usual practice in the design of shell and tube exchangers is to estimate the “true temperature difference” from the logarithmic mean temperature by applying a correction factor to allow for the departure from true counter-current flow:

$\Delta T_m = F_t * T_{lm}$, where F_t is the temperature correction factor and ΔT_m is true temperature.

5.2.8. Correction Factor

The correction factor is a function of the shell and tube fluid temperatures, and the number of tube and shell passes. It is normally correlated as a function of two dimensionless temperature ratios: use one shell tube passes

$$R = \frac{T_1 - T_2}{t_2 - t_1} = 2$$

$$S = \frac{t_2 - t_1}{T_1 - t_1} = 0.3333$$

$\Delta T_m = F_t * T_{lm}$, by using the R and S values from figure $F_t = 0.95$

$$\Delta T_m = 0.95 * 79.36 = 75.4^\circ \text{c}$$

Now, for the provisional area,

$$A = Q / \Delta T_m * U$$

$$A = 65700 / 75.4 * 50 = 17.4 \text{ m}^2$$

$$\text{For area of one tube,} = L * d_o * \pi = 2.44 \text{ m} * 0.02 \text{ m} * \pi = 0.146 \text{ m}^2$$

Now, Number of tube can be calculated as:

$$N_t = A / \pi L D_o = 20.54 \text{ say } 21$$

$$D_b = d_o \left(\frac{N_t}{k_1} \right)^{\frac{1}{n_1}} = 151.8 \text{ say } 152 \text{ mm}$$

5.2.9. Tube pitch and tube-layout

Tube pitch is the shortest Centre to Centre distance between the adjacent tubes. The tubes are generally placed in square or triangular patterns (pitch) as shown in the Figure

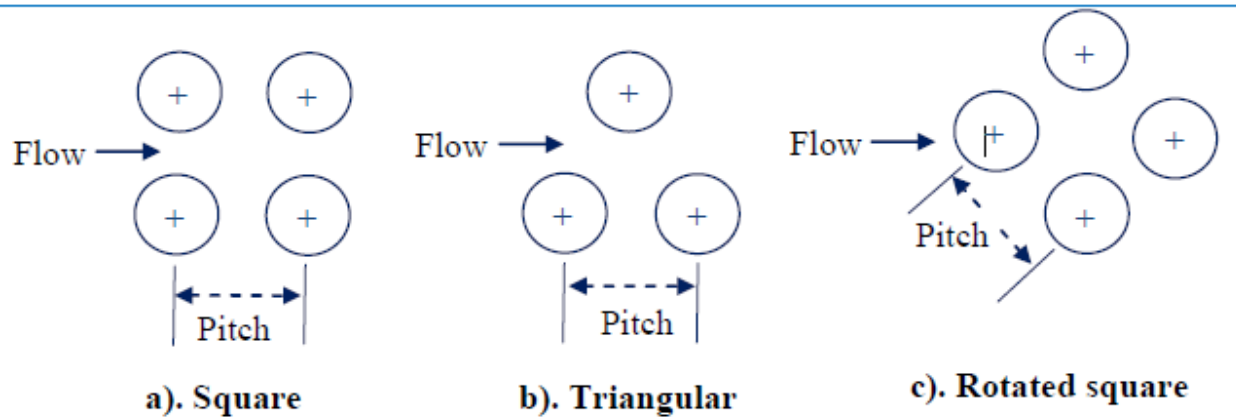

figure3.3 Heat exchanger tube-layout

The widely used tube layouts are illustrated in Table below

Table5.4Common tube layouts

Tube OD,in	Pitch type	Tube pitch,in
$\frac{3}{4}$	Square	1
1		$1\frac{1}{4}$
$\frac{3}{4}$	Triangular	$\frac{15}{16}$
$\frac{3}{4}$		1

A square layout is used for heavily fouling fluids, where it is necessary to mechanically clean the outside of the tubes. The recommended tube pitch (distance between tubes Centre's) is 1.25 times the tube outside diameter; and this will normally be used unless process requirements dictate otherwise. Where a square pattern is used for ease of cleaning, the recommended minimum clearance between the tubes is 0.25 in. (6.4 mm).

Therefore in this design the pitch is calculated as:

Pitch = 1.25*do, where do=tube outer diameter

Pitch = 1.25*20 =25mm which is equal to the listed in the table and tube clearance is obtained from $Ct = Pt - do = 25 - 20 = 5\text{mm}$

Where B = baffle spacing, Lt = tube length and Nb = number of baffle

From the design the length of tube is 2440mm and number of baffle is taken as 15, thus $B = \frac{2440}{15+1} = 152.5$ which is equal to the given interval of 0.2 to 1 and selected $0.984 * 155 = 152.52$

Baffles are held in positioned by means of baffle spacers. Closer baffle spacing gives greater transfer co-efficient by inducing higher turbulence. The pressure drop is more with closer baffle spacing. In case of cut-segmental baffle, a segment (called baffle cut) is removed to form the baffle expressed as a percentage of the baffle diameter. From the standard Baffle cuts from 15 to 45% are normally used. But a baffle cut of 20 to 25% provide a good heat-transfer with the reasonable pressure drop. The % cut for segmental baffle refers to the cut away height from its diameter. Therefore for this research in order to achieve greater transfer co efficient the percent of baffle cut is selected as 25%. Figure: below shows cut segmental of baffles.

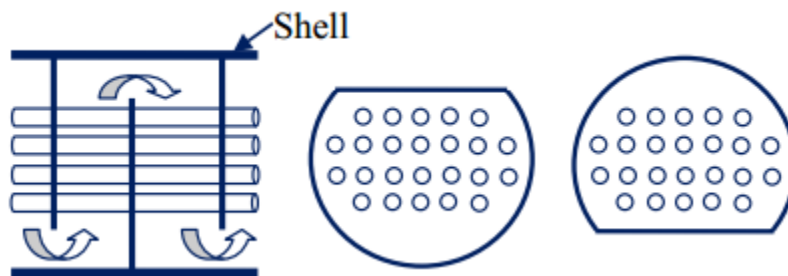

Figure5.4Cut-segmental baffle

5.3.4. Fouling Considerations

The most of the process fluids in the exchanger foul is the heat transfer surface. The material deposited reduces the effective heat transfer rate due to relatively low thermal conductivity. Therefore, net heat transfer with clean surface should be higher to compensate the reduction in performance during operation. Fouling of exchanger increases the cost of (i) construction due to oversizing, (ii) additional energy due to poor exchanger performance and (iii) cleaning to remove deposited materials. A spare exchanger may be considered in design for uninterrupted services to allow cleaning of exchanger. The effect of fouling is considered in heat exchanger design by including the tube side and shell side fouling resistances.

5.3.5. Selection of fluids for tube and shell side

The routing of the shell side and tube side fluids has considerable effects on the heat exchanger design. Some general guidelines for positioning the fluids are given in Table below

Table 5.5 Guidelines for placing the fluid in order of priority

Tube side fluid	Shell side fluid
Corrosive fluid	Condensing vapor (unless corrosive)
Cooling water	Fluid with large temperature difference (>40°C)
Fouling fluid	
Less viscous fluid	
High pressure steam	
Hotter fluid	

5.3.6. Shell and header nozzles (branches)

Standard pipe sizes will be used for the inlet and outlet nozzles. It is important to avoid flow restrictions at the inlet and outlet nozzles to prevent excessive pressure drop and flow induced vibration of the tubes.

5.3.7. Tube-Side Coefficient and Pressure Drop

$$\frac{hidi}{kf} = jhRe^{0.8}Pr^{0.33}\left(\frac{\mu}{\mu_w}\right)^{0.14} = Nu$$

Mean flue gas temperature = $190 + 80/2 = 135^\circ\text{C}$

Tube cross-sectional area = $\frac{\pi}{4} * 16^2 = 201\text{mm}^2$

Tubes per pass $21/1 = 21$

Total flow area = $21 * 201 * 10^{-6} = 0.042\text{m}^2$

Thermal conductivity = $0.89\text{ W/m}^2\text{ }^\circ\text{C}$

Flue gas mass velocity = $0.114/0.042 = 2.71\text{kg/sm}^2$

$Re = Gtde/\mu = 2.71 * 17.46/23.80 * 10^{-6} = 198809.2$, therefore $198809.2 > 10,000$ and the flow becomes turbulent

$$Pr = \frac{C_p\mu}{kf} = 0.671$$

$$\frac{L}{di} = \frac{2440}{16} = 152.5$$

From figure 4.7, $j_h = 21 * 10^{-3}$ or

$$Nu = \frac{h_i d_e}{k_f} = C Re^{0.8} Pr^{0.33}, \text{ where}$$

C = 0.021 for gases

C = 0.023 for non-viscous

C = 0.027 for viscous liquid the values for jh and C is approximately the same.

$$Nu = 0.021(198809.2)^{0.8}(0.671)^{0.33} = 318.99 W/m^2 \cdot ^\circ C$$

$$h_i = 67.85 W/m^2 \cdot ^\circ C$$

5.3.8. Tube-side pressure drop

There are two major sources of pressure loss on the tube-side of a shell and tube exchanger: the friction loss in the tubes and the losses due to the sudden contraction and expansion and flow reversals that the fluid experiences in flow through the tube arrangement.

$\Delta P_t = 8jf (L/d_i) \rho u^2/2$, where jf is the dimensionless friction factor and L is the effective pipe length. Values of jf for heat exchanger tubes can be obtained from Figure below;

$$\Delta P_t = 8 * 0.021 \left(\frac{2.44}{0.016} \right) * 0.788 * \frac{(2.71)^2}{2} = 74.13 pa$$

5.3.9. Shell-side coefficient

Choose baffle spacing = 152.5mm

Tube pitch = 1.25 * 20 = 25 mm

$$\text{Cross-flow area } A_s = \frac{(25 - 20)}{25} 213 * 152.5 * 10^{-6} = 0.0065 m^2$$

$$\text{Mass velocity, } G_s = \frac{250}{3600} * \frac{1}{0.0065} = 13.8 kg/s m^2$$

For a square pitch arrangement:

$$\text{Equivalent diameter } d_e = \frac{1.27}{20} (25^2 - 0.875 * 20^2) = 17.46 mm$$

$$\text{Mean shell side temperature} = \frac{80+25}{2} = 52.5^\circ C$$

$$Re = \frac{G_s d_e}{\mu} = 339.842 \text{ which is } < 10000 \text{ and it is laminar flow.}$$

$$Pr = \frac{C_p \mu}{k_f} = 5.650$$

Choose 25 percent baffle cut, from Figure

$$jh = 2.3 * 10^{-3}, Nu = \frac{h_s d_e}{k_f} = C Re Pr^{0.33}, \text{ where}$$

C = 0.021, for gas

C = 0.023, for non-viscous

$C = 0.027$, for viscous fluid, therefore the shell side fluid is non-viscous fluid and taken as $C = 0.023$, which is approximately equals to j_h . Now from the equation below,

$$Nu = \frac{h_s d_e}{k_f} = C Re Pr^{0.33} = 3.49 \text{ thus}$$

$$h_s = 123.49 W/m^2 \text{ } ^\circ C$$

Estimate wall temperature

Mean temperature difference across all resistance = $135 - 52.5 = 82.5^\circ C$, across water film = $18^\circ C$. Mean wall temperature = $135 - 18 = 117^\circ C$.

5.4. Overall coefficient

To Find the Overall Heat Transfer Coefficient Neglecting the Fouling Resistances,

$$\frac{1}{U_0} = \frac{1}{h_o} + \frac{d_o \ln\left(\frac{d_o}{d_i}\right)}{2k_w} + \frac{d_o}{d_i} * \frac{1}{h_i}, \text{ where}$$

$U_0 = \text{overall heat transfer coefficients.}$

$h_o = \text{out side fluid coefficients.}$

$h_i = \text{inside fluid coefficients.}$

$d_o = \text{tube outside diameter}$

$d_i = \text{tube inside diameter}$

$k_w = \text{thermal conductivity of tube wall materials.}$

$$\frac{1}{U_o} = \frac{1}{48976} + \frac{20 \ln(1.25)}{2} * 375 + 1.25 * \frac{1}{67.85} = 0.018448, \quad U_o = 54.2 \frac{W}{m^2 \text{ } ^\circ C}$$

It is above the assumed value and the design is safe.

Therefore, the rate of heat transfer in shell and tube heat exchanger can be expressed in an analogous manner to Newton's law of heating as;

$$Q = UA\Delta T_m = (54.2 * 17.4 * 75.4) \frac{W}{m^2 \text{ } ^\circ C} * m^2 * ^\circ C = 71108.232 W = 71.12 kW$$

5.4.1. Shell-Side Pressure Drop

5.4.2. Flow pattern

The flow pattern in the shell of a segmentally baffled heat exchanger is complex, and this makes the prediction of the shell-side heat-transfer coefficient and pressure drop very much more difficult than for the tube-side. Though the baffles are installed to direct the flow across the tubes, the actual flow of the main stream of fluid will be a mixture of cross flow between the baffles, coupled with axial (parallel) flow in the baffle windows; as shown in Figure below [26].

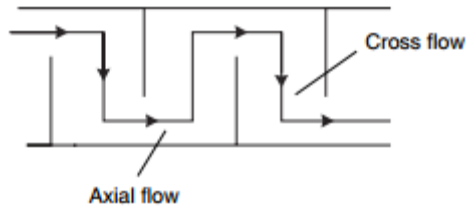

Figure 5.5 Idealized main stream flow

5.4.3. Kern's method

This method was based on experimental work on commercial exchangers with standard tolerances and will give a reasonably satisfactory prediction of the heat-transfer coefficient for standard designs. The prediction of pressure drop is less satisfactory, as pressure drop is more affected by leakage and bypassing than heat transfer. The shell-side heat transfer and friction factors are correlated in a similar manner to those for tube-side flow by using a hypothetical shell velocity and shell diameter. As the cross-sectional area for flow will vary across the shell diameter, the linear and mass velocities are based on the maximum area for cross-flow: that at the shell equator. The shell equivalent diameter is calculated using the flow area between the tubes taken in the axial direction (parallel to the tubes) and the wetted perimeter of the tubes; see Figure below [26].

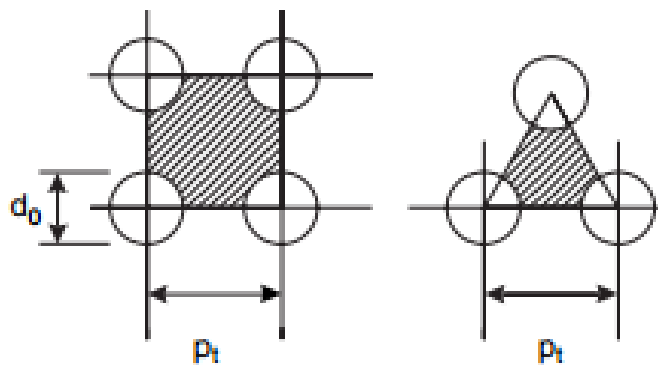

Figure 5.6 Equivalent diameter, cross-sectional areas and wetted perimeters

Shell-side j_h and j_f factors for use in this method are given in Figures 4.9 and 4.9.3, for various baffle cuts and tube arrangements. These figures are based on data given by Kern (1950) and by Ludwig (2001).

The procedure for calculating the shell-side heat-transfer coefficient and pressure drop for a single shell pass exchanger is given below:

1. Calculate the area for cross-flow A_s for the hypothetical row of tubes at the shell equator, given by:

$$A_s = \frac{(Pt - do)DsLb}{Pt}, \text{ where } pt = \text{tube pitch,}$$

do = tube outside diameter,

Ds = shell inside diameter, m,

Lb = baffle spacing, m.

The term $(pt - do)/pt$ is the ratio of the clearance between tubes and the total distance between tube centers.

2. Calculate the shell-side mass velocity G_s and the linear velocity U_s :

$$G_s = W_s / A_s$$

$$U_s = G_s / \rho$$

Where W_s = fluid flow-rate on the shell-side, kg/s,

ρ = shell-side fluid density, kg/m³.

3. Calculate the shell-side equivalent diameter (hydraulic diameter), for a square pitch

$$\text{arrangement: } de = \frac{4 \left(\frac{Pt^2 - \pi do^2}{4} \right)}{\pi do} = \frac{1.27}{do} (Pt^2 - 0.785 do^2)$$

4. The shell-side Reynolds number, given by:

$$Re = \frac{G_s de}{\mu} = \frac{u_s de \rho}{\mu}$$

5. For the calculated Reynolds number, read the value of j_h from Figure, for the selected baffle cut and tube arrangement, and calculate the shell-side heat transfer coefficient h_s from:

$$Nu = \frac{h_s de}{k_f} = j_h Re Pr_3^{1/4} \left(\frac{\mu}{\mu_w} \right)^{0.14}$$

6. For the calculated shell-side Reynolds number, read the friction factor from Figure, and calculate the shell-side pressure drop from:

$$\Delta P_s = 8 j_f \left(\frac{D_s}{de} \right) \left(\frac{L}{L_b} \right) \rho u_s^2 / 2 \left(\frac{\mu}{\mu_w} \right)^{-0.14}, \text{ where } L = \text{tube length, } L_b = \text{baffle spacing.}$$

The term (L/L_b) is the number of times the flow crosses the tube bundle = $(N_b + 1)$, where N_b is the number of baffles.

$$\Delta P_s = 8 * 0.023 \left(\frac{213}{17.46} \right) \left(\frac{2440}{152.5} \right) 998 * \frac{13.8^2}{2} = 3378.76 \text{ pa}$$

5.4.4. CFD Methodology and analysis

In this research paper a design model of shell and tube type heat exchanger which is having both interacting mediums as water and hot flue gas is designed. First shell and tube heat exchanger is designed to heat water from 25°C to 80°C by hot flue gas from incinerator at 190°C. The design is done using Kern's method in order to gain various dimensions such as shell, tubes, baffles etc. A model is developed using ANSYS 16.0 based on the calculated dimensions of heat exchanger. After developing the model the thermal simulation in ANSYS has been executed by applying several thermal loads on different faces and edges. The heat transfer capacities of more than a few thermal materials has been equated by assigning different materials.

Computational fluid dynamic study of the system starts with building desired geometry and mesh for modeling the domain. Generally, geometry is simplified for the CFD studies. Meshing is the discretization of the domain into small volumes where the equations are solved by the help of iterative methods. Modeling starts with defining the boundary and initial conditions for the domain and leads to modeling the entire system domain. Finally, it is followed by the analysis of the results.

5.4.5. Governing Equations

In shell and tube heat exchangers, three dimensional flows have been simulated by solving the governing equations. Energy, conservation of mass and momentum can do using ANSYS CFD package. Shear stress transport (SST) $k-\omega$ model of closure. Take care the turbulence which has a blending function that supports standard $k-\epsilon$ elsewhere. And $k-\omega$ nears the wall.

5.4.6. Flow Calculation

Flow is governing by the energy equation, navier-stokes momentum equation and continuity equations. Convective flow, diffusion of molecules and turbulent eddies are the reason for occurring of transport of mass, energy and momentum. In three dimensions, where $i, j, k = 1, 2, 3$ setup over a control volume corresponding with all equations.

5.4.7. Continuity Equation

Conservation of mass is described by the continuity equation, and the equation is written as,

$$\frac{\partial \rho}{\partial t} + \frac{\partial \rho U_1}{\partial x_1} + \frac{\partial \rho U_2}{\partial x_2} + \frac{\partial \rho U_3}{\partial x_3} = 0 \dots \dots \dots \text{eqn5.5}$$

$$\text{or } \frac{\partial \rho}{\partial x} + \frac{\partial \rho U_i}{\partial x_i} = 0, i = 1, 2, 3 \dots \dots \dots \text{eqn5.6}$$

heat exchanger, and the tube side is built with 1 common inlets comprising of 21 complete tubes. The shell outlet length is also increased to facilitate the modeling program to avoid the reverse flow condition. In the Figure 3.3, the simplified geometry can be seen.

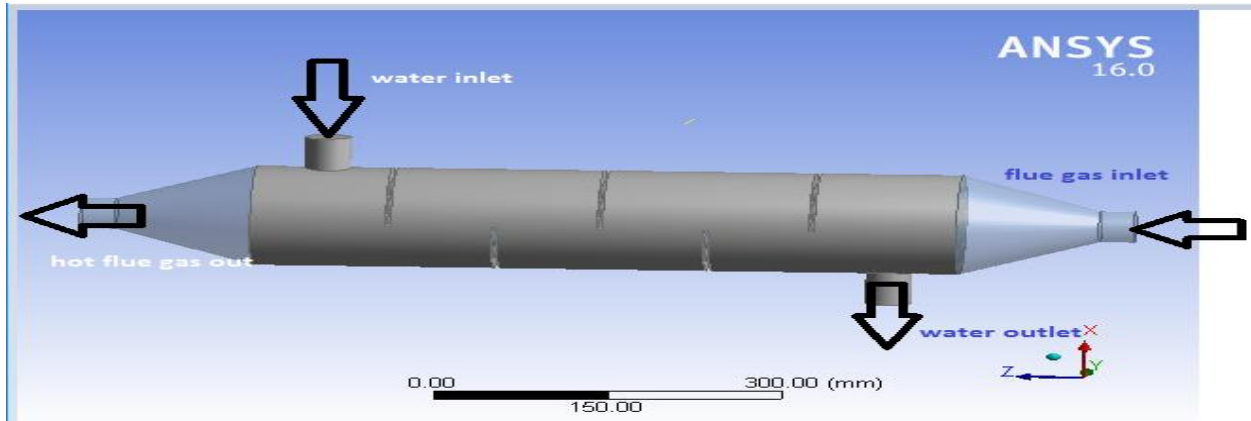

Figure 5.7 Simplified geometry of shell and tube heat exchanger

The dimensions of the geometry are also given in the Table below.

Table 5.6 Heat exchanger dimension

No	Description	Unit	Value
1	Overall dimensions	mm	50X330X2440
2	Shell diameter	mm	160
3	Tube outer diameter	mm	20
4	Tube inner diameter	mm	16
5	Number of tubes	In numbers	21
6	Shell/Tube length	mm	2440
7	Inlet length(impingement)	mm	70
8	Outlet length(impingement)	mm	100
9	Baffle	mm	with 25% cut
10	Number of baffle	In number	15

5.5.1 Mesh

initially a relatively coarser mesh is generated. This mesh contains mixed cells (Tetra and Hexahedral cells) having both triangular and quadrilateral faces at the boundaries. Care is taken to use structured cells (Hexahedral) as much as possible, for this reason the geometry is divided

into several parts for using automatic methods available in the ANSYS meshing client. It is meant to reduce numerical diffusion as much as possible by structuring the mesh in a well manner, particularly near the wall region. Later on, for the mesh independent model, a fine mesh is generated. For this fine mesh, the edges and regions of high temperature and pressure gradients are finely meshed.

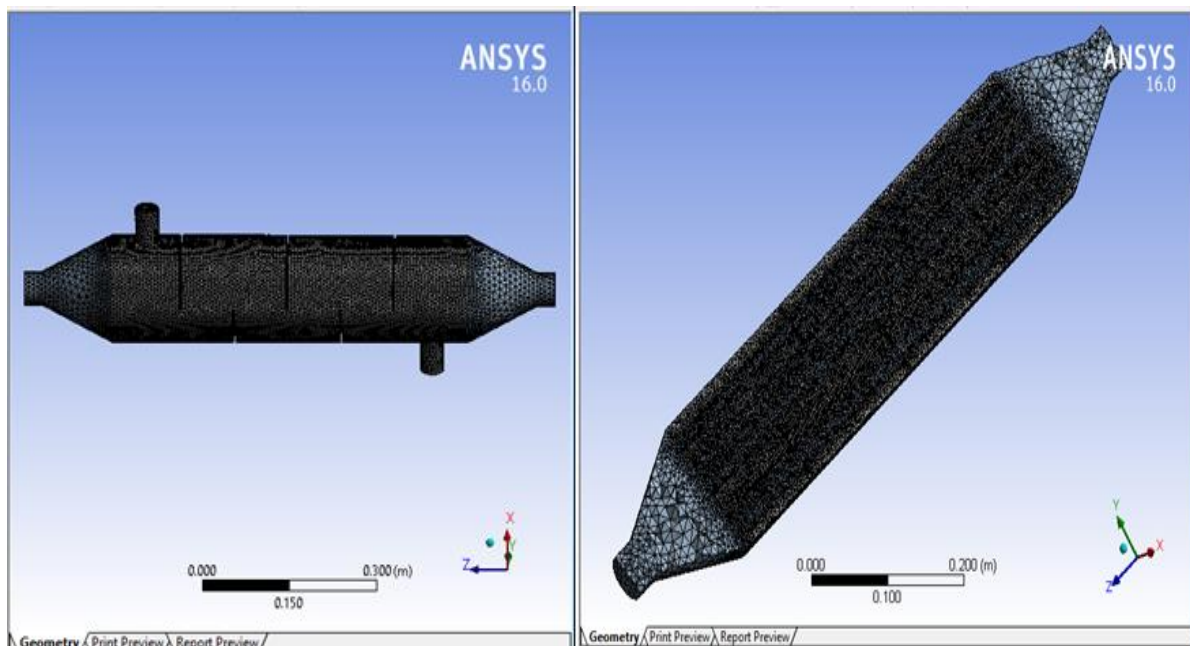

Figure 5.8 sectioning of meshes and show whole element

5.5.2. Boundary Conditions

Boundary conditions are used according to the need of the model. The inlet and outlet boundary conditions have velocity and pressure respectively in both the fluids. In each 21 tubes have 21 similar inlet and outlet boundary conditions. These are used to estimate the turbulence boundary conditions which are specified by estimating the turbulence intensity and length scale. Later it is seen that the turbulence boundary conditions have a very little effect over the results and solution. The walls are separately specified with respective boundary conditions. 'No slip' condition is considered for each wall. Except the tube walls, each wall is set to zero heat flux condition. The tube walls are set to 'coupled' for transferring of heat between shell and tube side fluids. The details about all boundary conditions can be seen in the table below.

Table5.7boundary condition setup

	Boundary Condition	Shell	Tube
Inlet	Velocity Inlet	1	1.5
Outlet	Pressure Outlet	0	0
Wall	No Slip Condition	No heat flux	Coupled
Turbulence	Turbulence Intensity	5%	5%
Temperature	Inlet Temperature	298K	463K
Mass Flow rate		0.26	0.0547

5.5.3. Measure of Convergence

It is tried to have a good convergence throughout the simulations. The solution time increases if the convergence criterion is made strict. Good thing about this model is that it doesn't take too much time to converge. Thus a strict criterion is possible to get good accurate results.

Table5.8residuals

Variable	Residual
X-Velocity	10^{-6}
Y-Velocity	10^{-6}
Z-Velocity	10^{-6}
Continuity	10^{-6}
Dissipation Energy	10^{-6}
Turbulent Kinetic Energy	10^{-5}
Energy	10^{-9}

5.5.4. Solution

5.5.5.Run-Calculation

After giving the boundary conditions to the inner and outer fluid (tube side and shell side), finally we have to run the calculations. The number of iteration is set to 5000 and the solution is calculated and various contours, vectors and plots are obtained.

5.5.6. The Post-processor

The post-processor is the last part of CFD software. It helps to examine the results and extract useful data. The results may be displayed as vector plots of velocities and contour plots of scalar Variables such as pressure, temperature, streamline and animation in case of steady simulation was displayed.

CHAPTER SIX

6. Result and Discussion

6.1. Result of Energy Assessment

The energy assessment of solid waste from JURH is dependent on the daily throughput waste containing calorific value. Since energy is measured in joules. Therefore the daily throughput waste or generation rate of each waste by mass is summarized in table below.

Table6. 1 Mass distribution of combustible waste categories

No	Type	%of generation rate
1	Plastic(including, pharmaceutical, hard and soft plastic)	50.45
2	Textiles (including, garments, facial matter, bedding....)	19.94
3	Papers, cardboard	24.63
4	Wood(shavings and leaves)	3.00
5	Total	98.02

The total waste per day in this hospital is 1189.5kg/day; the estimation of generation waste in Annually is 434167.5kg/year or 434.2tonnes/year.

Thus the average heating value of the waste is 22359.5kj/kg and the energy required to heat one liter of water is 230.23kj/kg.

This result is obtained from the equation, $E = mC_p\Delta T$Eqn6.1

Where, E = energy

m = mass of fluid (water)

C_p = specific heat of water and

ΔT = is the change in temperature

This means raising temperature of one liter by 1°C needs 4.186kj/kgk, but it is required to raise the temperature to 80°C by considering room temperature 25°C and subtracting this two variables gives 55°C, thus $55 \times 4.186 = 230.23$ kj of energy is required to heat one litter of water by 55°C and finally 230.23kj/kg of energy is needed to heat one litter of water to 80°C.

From the above topic there was briefly discussed the hospitals daily demand of hot water as 7431.25liter per day. The total heat required is therefore; $230.23\text{kj/kg} \times 7431.25\text{kg} = 1710.9\text{MJ}$, but from the waste generation calorific value is calculated as 26596.6MJ (7387.95kwh) which is

above the required value of heat and the design study was feasible. From 7387.95kwh the hospital was used only 475.25kwh of heat for water heating application and the rest 6912.7kwh of heat is strayed without any application. Thus using this heat energy for space heating application is possible if needed, and this also increase our energy management system and it ensures cost saving.

6.2. Proximate Analysis and Moisture content

Proximate analysis is the analysis of wastes to determine moisture content, ash content and fixed carbon. Thermo-chemical behavior of waste such as moisture content, ash content, volatile matter and fixed carbon were determined by standard procedures [19]. The moisture content is determined by the loss in weight that occurs when a sample is dried in a laboratory oven at 105 °C for 1 hour. The volatile matter has been determined by involving measurement of weight loss following combustion of about 1g waste in a furnace at 950°C for 6 min. To determine the ash content, the char samples were further heated in a laboratory ash furnace at 750 °C for at least 3 hours. The results of the proximate analyses of the waste are shown in Table below.

Table6. 2Result of proximate analysis and calorific value from Ethiopian geological survey laboratory

Category	Moisture%	Volatile%	Fixed carbon%	Ash%	Calorific value%
HW-01	0.465	92.84	11.85	6.695	8419.31 or 35250kj/kg
HW-02	7.56	86.68	11.76	5.76	3976.78 or 16650kj/kg
HW-031	3.30	77.04	9.54	9.94	4190.83 or 17546.167kj/kg
HW-032	1.79	75.95	7.77	14.40	3439.68 or 14401.252kj/kg
HW-04	12.52	85.17	11.74	2.31	6675.74 or 27950kj/kg
Total	25.635	417.68	52.66	39.105	26702.34or 111797.419kj/kg
Average	5.127	83.536	10.532	7.821	5340.468or22359.4838kj/kg

The proximate analysis was done in Ethiopian geological survey laboratory Addis Ababa.

Calorific value can be determined experimentally or from theoretical considerations. In laboratory Bomb calorimeter is used where 1g board card is combusted at constant volume and rise in temperature is noted.

6.3. Ultimate Analysis

Ultimate analysis (elemental analysis) is the analysis of waste to determine percent of C, H, O, N, S and ash represented in weight percent on a dry basis (wt. % on a dry basis).

Samples analyses proved that carbon became the most dominant component, followed by oxygen. The average percentage of hydrogen and nitrogen contents in the samples was lower than 10%. Hydrogen and oxygen are contained in MSW not as gasses, but they are bound by the other substances. Oxygen is eight times lighter than hydrogen. Hence, more oxygen is required to burn hydrogen to form H₂O. Plastic has the highest carbon content (80% wt.). Wood mostly contains oxygen (44.43wt. %), whereas plastic has the lowest oxygen content (3.98%wt.). Meanwhile, the highest H is contained in plastic. In a combustion process, C and H are oxidized by the exothermic reaction to form of CO₂ and H₂O.

An ultimate analysis (elemental analysis, C, H, N, S, and O) was done in Addis Ababa University, College of Natural and computational science, Department of chemistry.

Table6. 3 Result of Ultimate analysis from AAU of college of natural science chemistry department

Sample Type	C	H	N	Total
Plastic	47.2	4.65	0.05	51.9
Paper	41.43	6.87	1.01	49.31
Textile	41.19	6.97	0.01	48.17
Wood	45.69	7.57	1.89	55.15
Average	43.8775	6.515	0.74	51.13

Oxygen content was calculated from equation shown below

$$O = 100 - (C+H+N+Ash+Moisture) \dots \dots \dots \text{Eqn6.2}$$

$$O = 35.912$$

6.4. Calorific Value

The heating value (or energy value or calorific value) of a substance, usually a fuel or food is the amount of heat released during the combustion of a specified amount of it. The calorific value is the total energy released as heat when a substance undergoes complete combustion with oxygen under standard conditions. The chemical reaction is typically a hydrocarbon or other organic molecule reacting with oxygen to form carbon dioxide and water and release heat. It may be expressed with the quantities: energy/mole of fuel, energy/mass of fuel and energy/volume of the

fuel. The calorific value is conventionally measured with a bomb calorimeter. It may also be calculated as the difference between the heat of formation of the products and reactants (though this approach is purely empirical since most heats of formation are calculated from measured heats of combustion). The sample is weighted and placed in a digital Bomb calorimeter for lower heating value determination. The digital Bomb calorimeter is then sealed and the waste sample is ignited electrically. The complete combustion of the waste releases heat and it is measured through the temperature change, which is measured by using a digital sensor, of the water bath surrounding the bomb calorimeter. The heat of combustion can be calculated from the resulting rise in temperature. The same step is re-repeated for accurately determining heating value.

Table6. 4 Result of calorific value [35]

Category	Calorific value%
HW-01	8419.31 or 35250kj/kg
HW-02	3976.78 or 16650kj/kg
HW-031	4190.83 or 17546.167kj/kg
HW-032	3439.68 or 14401.252kj/kg
HW-04	6675.74 or 27950kj/kg
Total	26702.34or 111797.419kj/kg
Average	5340.468or22359.4838kj/kg

6.5. CFD Result

Once the problem is solved the next and last step is to analyze the result in CFD post. The solution is converges after 5000 iteration.

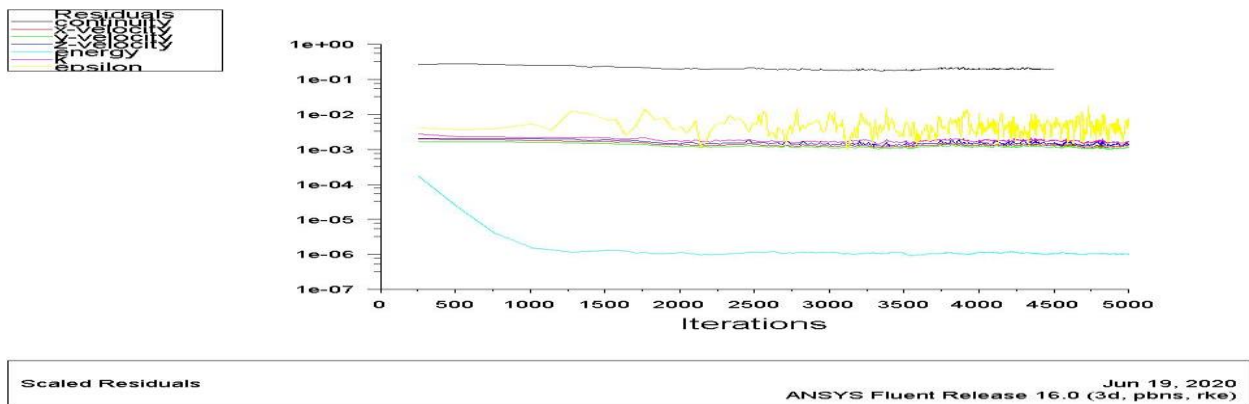

Figure6. 1 residue for STHX model,5000 iteration

For appropriate graphical representation and report, we analyze the results in terms of contour plot, vector plot and streamlines. Here because of the problem is thermal based it is interested to find out the temperature value at different sections.

From the Section of plane z-x at the mid of the geometry which helps to show the temperature contour at that plane is shown. Here from contour we observe that the significant changes like temperature drops in hot fluid(tube side temperature drop) and temperature rise of the cold fluid(shell side temperature increase). As per CFD analysis of shell and tube models of heat exchangers with the variations in tubes we found the inlet outlet temperatures.

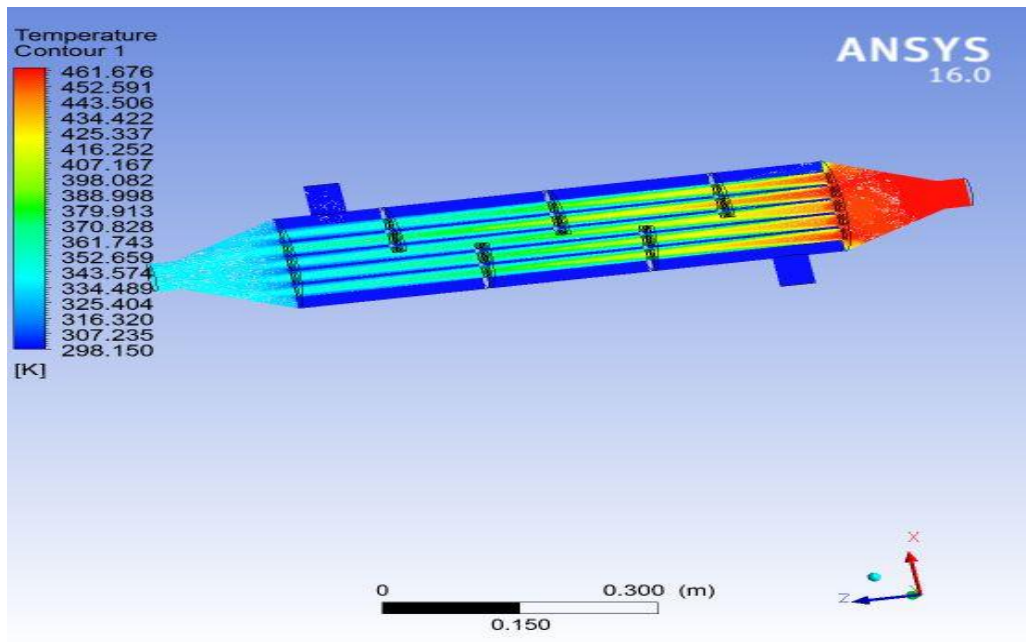

Figure6. 2 Temperature contour on z-x plane

The above fig shows that the temperature distribution at different length by various colors on z-x plane due to heat exchanger.

Again taking z-x section plane to show case the temperature distribution at different locations such as inlets and outlets of shell and tube heat exchangers described below.

1. Temperature contours at tube inlet: here dropping temperature at the tube inlet of flue gas can be easily seen; because of at the inlet of the tube heat of burning waste material with high temperature is flowing to the tube in the form of flue gas.

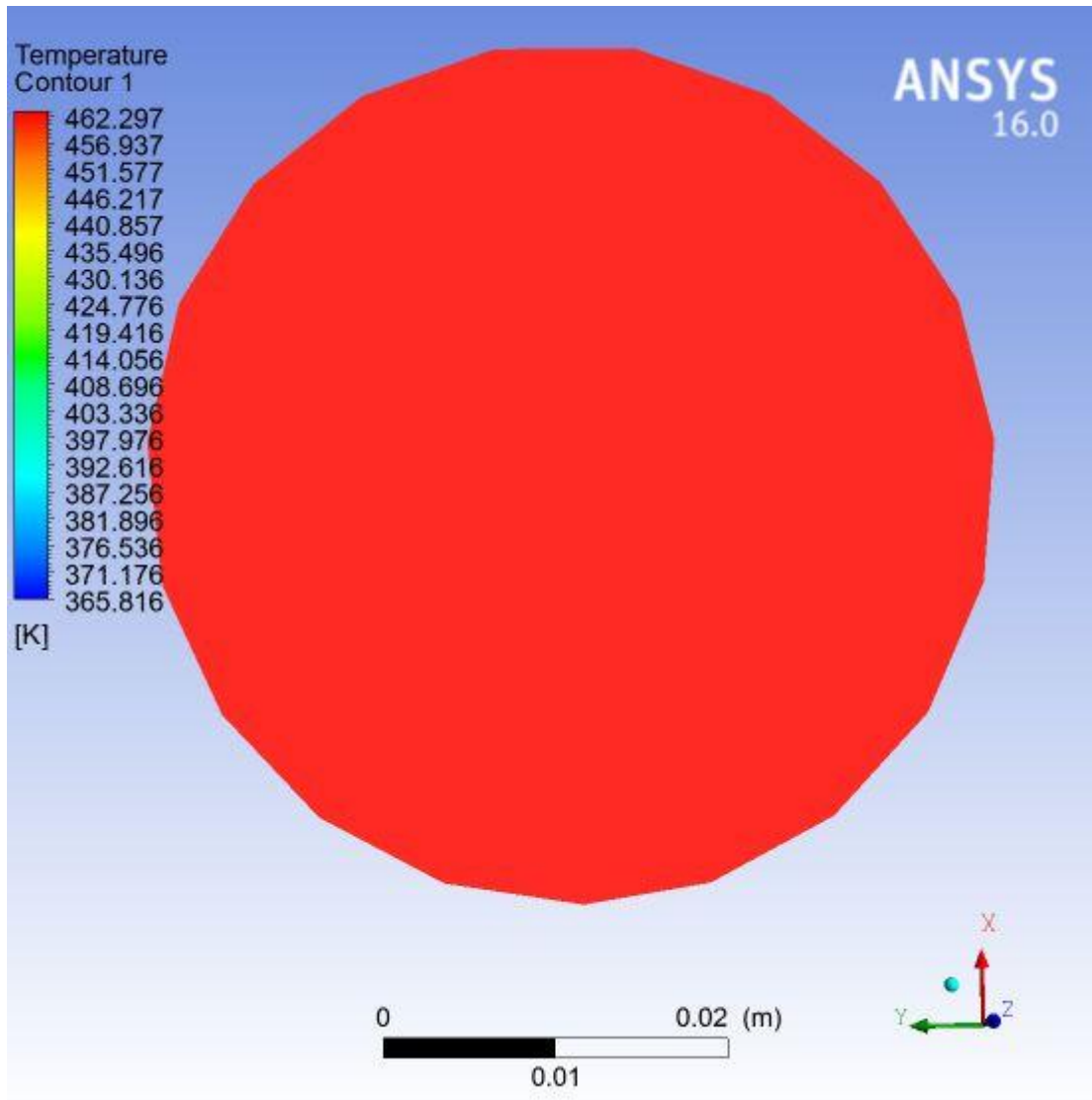

Figure6. 3 Temperature contour at tube inlet

2. Temperature contour at shell inlet: also in this case (from the figure) we can easily observe that the temperature rise at shell side and temperature drop at tube side is seen.

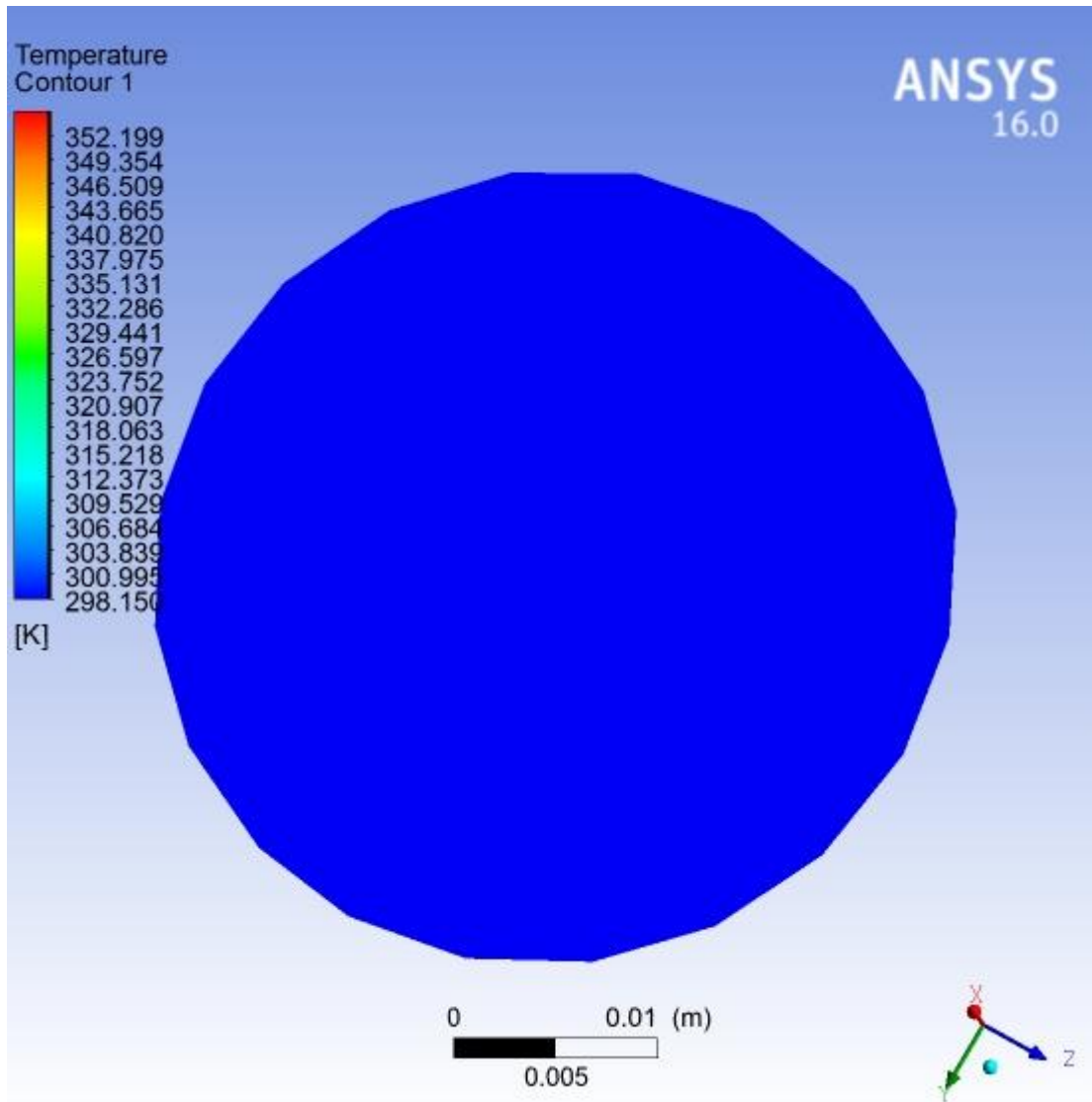

Figure6. 4 Temperature contour at shell inlet

3. Shell outlet: the temperature contour at shell outlet represent that the temperature is increasing at shell side and decreasing at tube side because of heat transfer is occurred on both of the fluid.

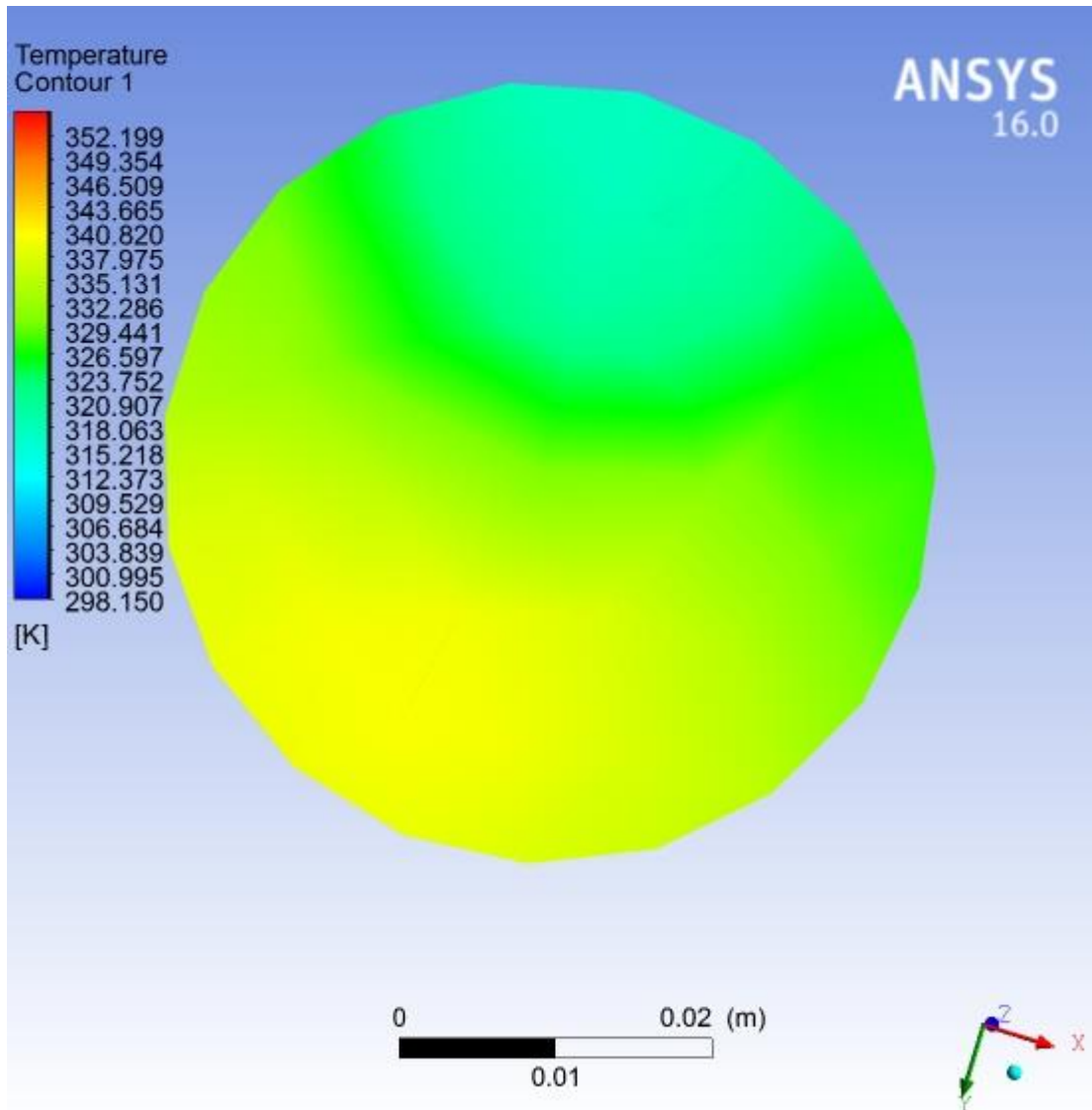

Figure6. 5 Temperature contour on shell outlet

4. Tube outlet: from this we can observe that the temperature of a fluid is decreased (dropped) at outlet as compared to the tube inlet b/c the maximum heat transfer from hot fluid to that of cold fluid.

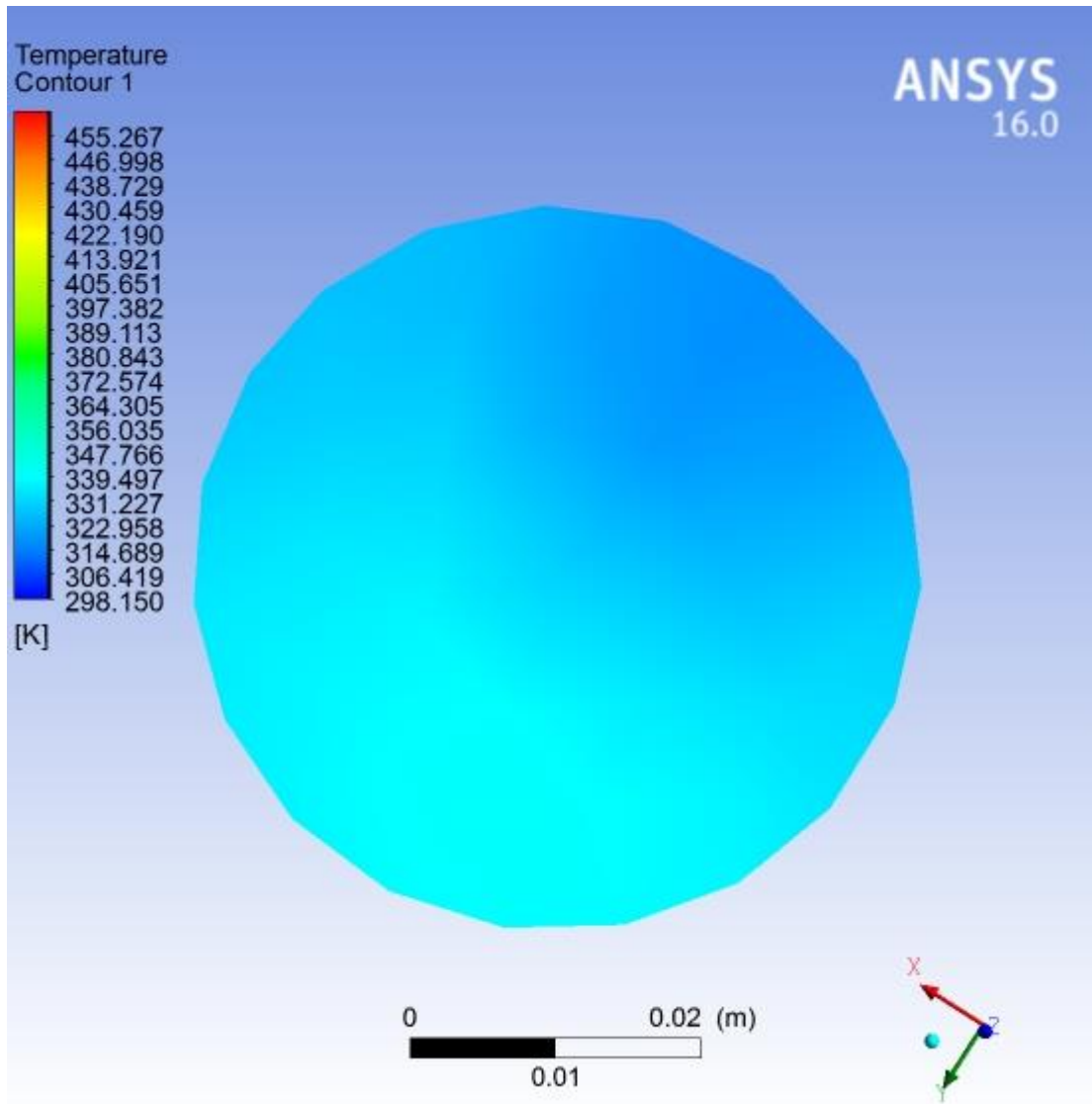

Figure6. 6 Temperature contour at tube outlet

Know we can move further to check the velocity streamlines for tube side. We can observe that the flow pattern along the velocity in tube side. It is seen that the animation of the flow from the tube inlet to tube outlet.

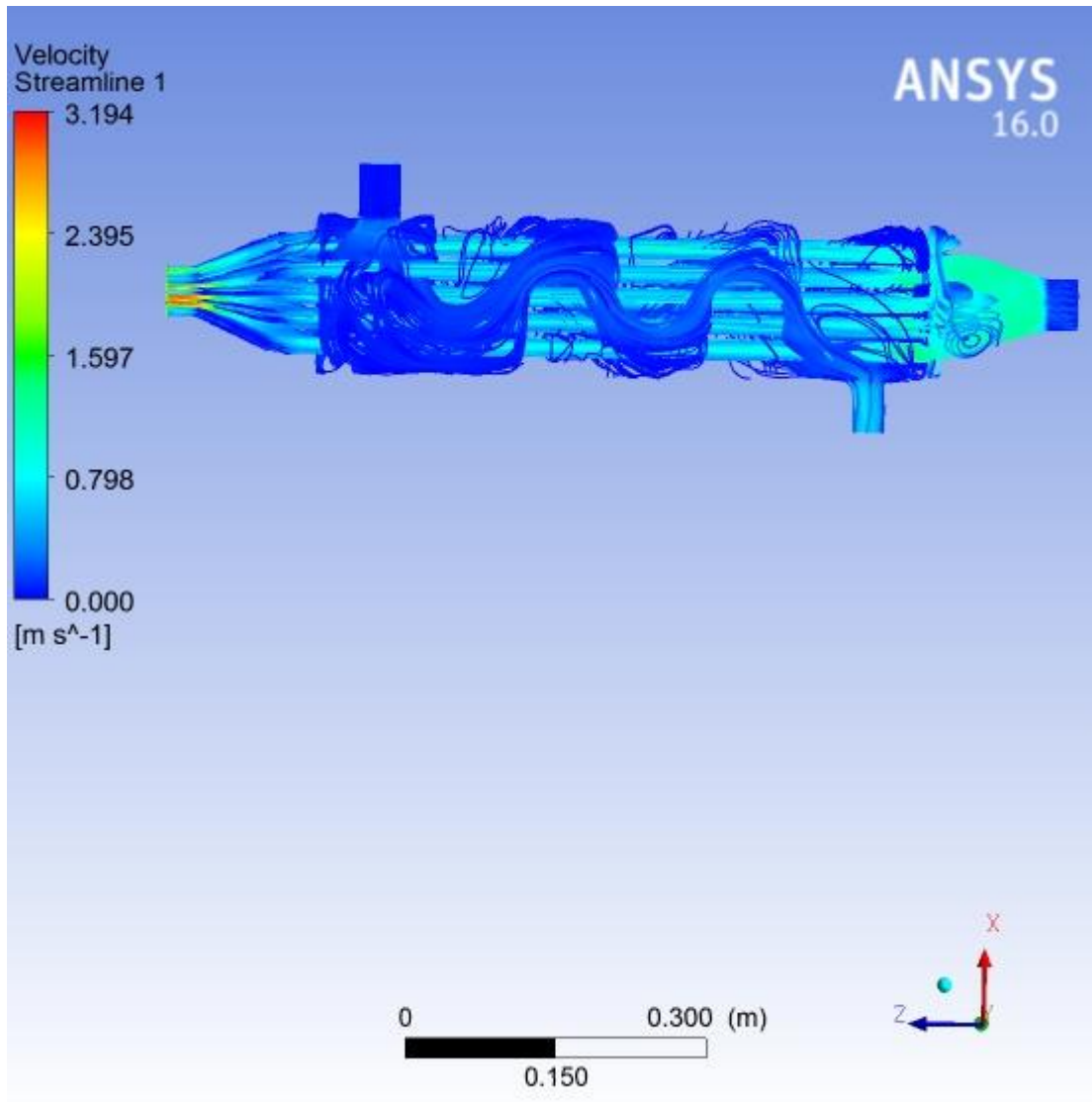

Figure6. 7 animated result of velocity streamline

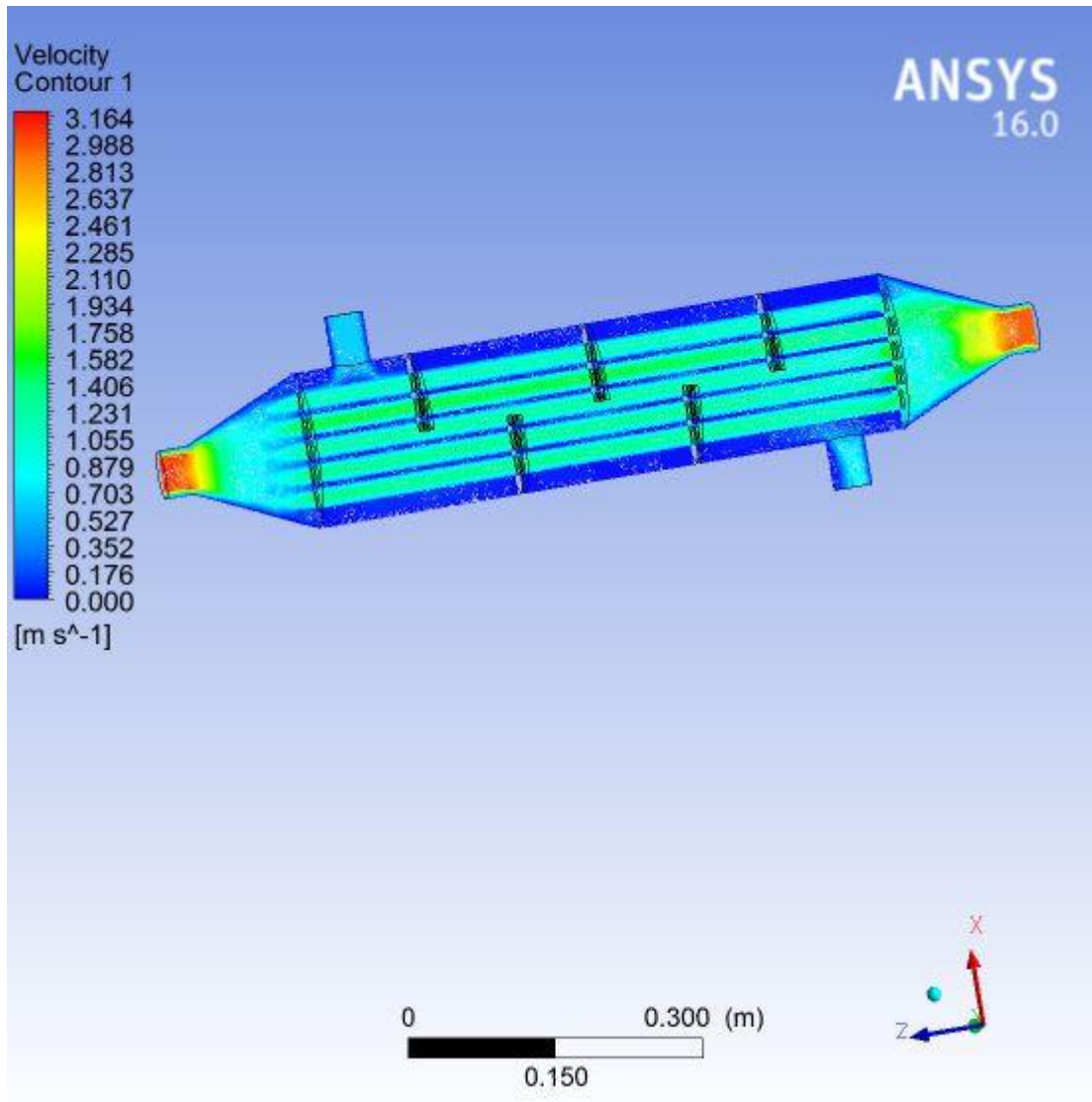

Figure6. 8 velocity contour on z-x plane

The above fig shows velocity distribution at different length by various colors on z-x plane due to heat exchanger

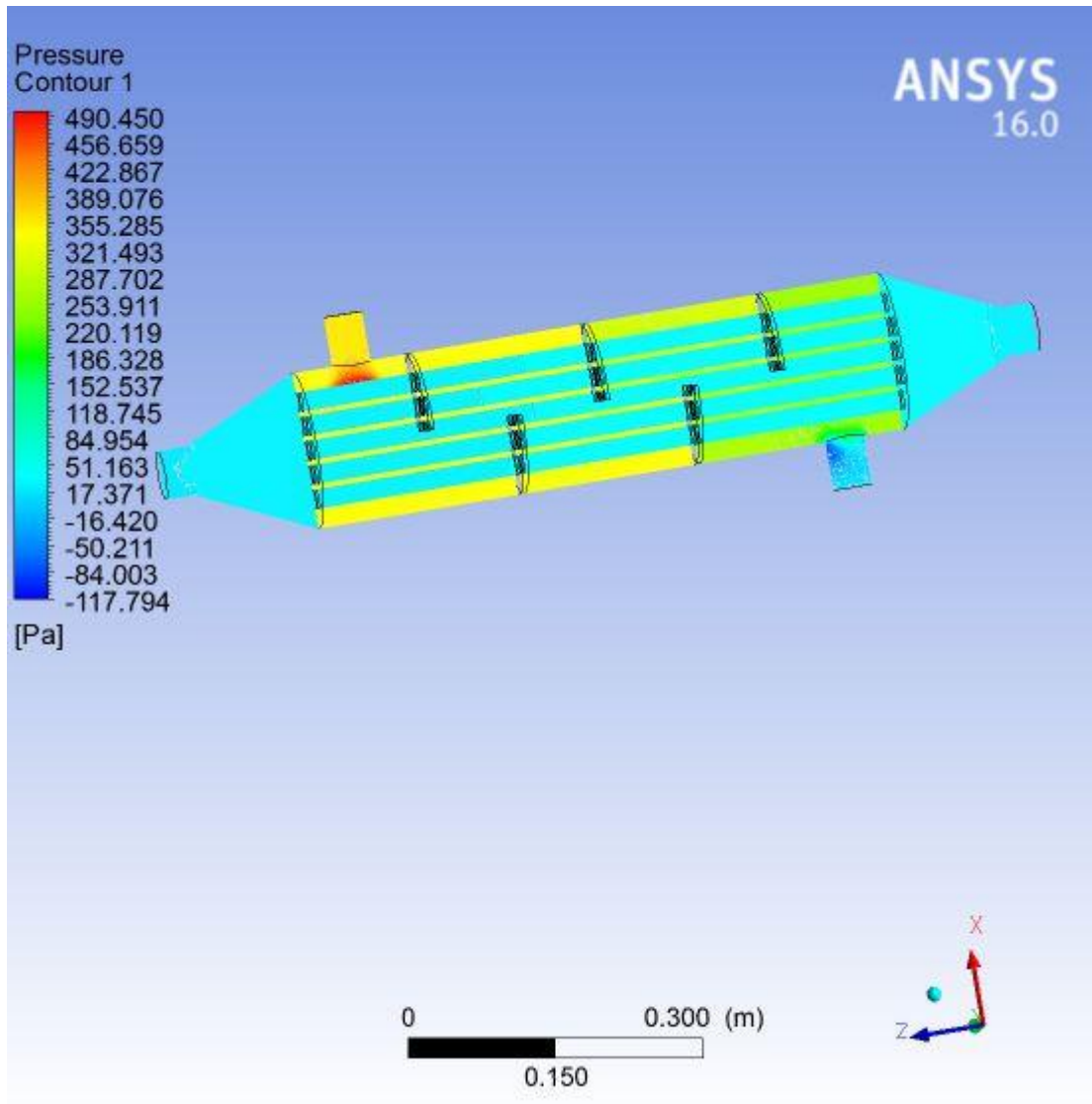

Figure6. 9 pressure contour on z-x plane

The above fig shows pressure distribution at different length by various colors on z-x plane, and its drop due to heat exchanger.

CHAPTER SEVEN

7. Conclusions and Recommendation

7.1. Conclusions

This research presents design and analysis of shell and tube heat exchanger for Hot water supply to Jimma university referral hospital building. To achieve the objective of the study different approaches are performed. A detailed mathematical calculation for the shell and tube heat exchanger components like baffle, tube bundle, tube sheet and energy content of waste throughout from the hospital, waste generation rate per day and hot water demand per day as well as energy required to heat water using bomb calorimetric device and using energy equation formula was briefly presented.

From the model results, Obtained that temperature of cold fluid is increased from 298.15 to 352.199°K and temperature of hot fluid decreases 463.15 – 365.816°K. Consequently the comparisons of temperatures of calculated (estimated) value to the attained CFD value are almost valid. The calculated (estimated) value of temperature of hot water is 353K, and from CFD result the temperature of hot water is displayed 352.2K which is almost the same.

Pressure values are dropped from Inlet-490.450 Pa, to outlet- (-117.794) Pa. Stream line & Vector velocity values are varied from 0-3.194m/s.

From economic analysis, it was found that for Jimma university referral hospital of total daily hot water consumption of 7431.25kg, which is the energy requirement of 1710.9MJ per day, and thus converting this energy to kWh for the estimation of cost per kwh. therefore, from the solved value it is converted to $1710.9\text{MJ} = 475.25\text{kwh}$ and from Ethiopian energy tariff for commercial use per kwh is 0.54birr, thus to estimate daily consumed energy for water heater in terms of cost per kwh is multiplying the energy demand in kwh by a unit cost of 0.54, and thus $475.25 * 0.54 = 256.63\text{ETB}$ per day is saved by using waste heat recovery, i.e shell and tube heat exchanger, because of as energy liberated (released) from the hospital incinerator in the form of heat is “free”, once the installation costs have been met, a waste heat recovery for hot water system can reduce fuel bills and in addition, it can reduce the pollutant emission.

7.2. Recommendation

- ✓ JURH is bankable (profitable) if shell and tube heat exchanger is manufactured and installed to the hospital waste incinerating plant for recovering hot flue gas to apply water heating application because of free energy liberating from incinerator.

For the future work, the following points can be recommended.

- During simulation, use transient instead of steady state and higher iteration number greater than 20,000 to improve good result.
- Enhancement of shell and tube heat exchanger by using different types of heat exchanger , i.e. parallel flow tube, 'S'-pattern tube etc., and make comparison of them on CFD.
- Parametric studies can be done on the environmental effect of flue gas after it leaves from exchanger and mix with air.

References

- [1] Seadon, J.K. Integrated Waste Management – Looking beyond the Solid Waste Horizon. Waste Mgt. Vol. 26 (12). Pp. 1327-1336. (2006).
- [2] Satish K. Maurya, carried, analytical study on the waste heat recovery Combined Ejector and Vapour Compression Refrigeration System, International Journal of Engineering Sciences & Research Technology [1422-1425].
- [3] Maxi Brochure 05: “Energy Efficiency in Hospitals”, December 2015.
- [4] Ministry of water and Energy, Ethiopian national energy policy, (2nd draft), Ethiopia Addis Ababa, February, 2013.
- [5] “Solar Thermal Combined Heat and Power Project at the Energy Resource Center”, Southern California Gas Company, August 2014.
- [6] Clarke, M. J. Introduction to Waste Prevention and Recycling, Air and Waste Management Assoc. Annual Meeting. Baltimore MD Paper No. 45362. P.17. June 23-27, 2002.
- [7] Kassenberg, A. and R. de Sutter, Strategic Evaluation on Environment and Risk Prevention under Structural and Cohesion Funds for the Period 2007-2013. National Evaluation Report for Poland (2006).
- [8] UNDP/UNCHS/WORLDBANK.,conceptual framework for municipal solid waste management in low income countries vadianstrass42: SKAT (swiss center for development cooperation in technology and management). 1996
- [9] Rakesh Jain, Performance Improvement of a Boiler through Waste Heat Recovery from an Air Conditioning Unit, International Journal of Innovative Research in Science, Engineering and Technology Vol. 2, Issue 2, February 2013.
- [10] “Solar Thermal Systems: Solar Heating R&D”, U.S. Department of Energy Solar Energy Technologies

- [11] Yogendra Saidawat, Power Generation from Waste Heat Extracted Through Clinker Production in Cement Industry, International Journal in IT and Engineering, Vol.03 Issue-06, (June, 2015) ISSN: 2321-1776. SN: 2321-9637
- [12] R. Loganathan, waste heat recovery steam generator in sponge iron plant, The SIJ Transactions on Industrial, Financial & Business Management (IFBM), Vol. 1, No. 1, March-April 2013, ISSN: 2321 – 242X.
- [13] S. Umamaheswari, Growing Trend of Process off Gas and Waste Heat Recovery in Captive Power Generation, International Journal Of Scientific Research, Volume: 2 | Issue: 11 | November 2013 • ISSN No 2277 – 8179.
- [14] Zhongyi Su, Analysis of energy utilization and waste in China's processing industry based on a case study, the 7th International Conference on Applied Energy – ICAE2015, Energy Procedia 75 (2015) 572 – 577.
- [15] Senda FM. Aspects of waste heat recovery and utilization (WHR&U) in Pebble Bed Modular. Master of Science thesis, the University of Stellenbosch, South Africa (2012).
- [16] U.S. Energy Information Administration. Consumption & Efficiency. 25 6 2015. 1 7 2015 <http://www.eia.gov/consumption/>.
- [17] U.S. Energy Information Administration. Today in Energy. 7 3 2013. 1 7 2015 <http://www.eia.gov/todayinenergy/detail.cfm?id=10271>.
- [18] Demiss Alemu: Optimal Design of Solar Water Heating System, Zede, No.15, Addis Ababa, 1998.
- [19] Tchobanoglous G., Theisen. And Samuel A., Integrated Solid Waste Management Engineering Principles and Management Issues McGraw-Hill. Singapore, 1993.
- [20] Pooja G. Nidoni, Incineration Process for Solid Waste Management and effective Utilization of by Products Volume: 04 Issue: 12 | Dec-2017
- [21] Sieder and Tate (1936)

- [22] Aluminum Brazing Handbook, 4th edition, Aluminum Association, Washington, D. C., 1990.
- [23] Energy management handbook / by Wayne C. Turner & Steve Doty©2007 by The Fairmont Press, Inc.
- [24] Bevevino, J.W., et. al., “Standards of Tubular Exchanger Manufacturing Association,” TEMA, New York, 6th Edition, (1988)
- [25] Mr.Santosh K Katarki, Mr. Anandkumar S Malipatil, CFD Analysis of Shell and Tube Heat Exchanger for Heat Transfer Capabilities, International Journal of Engineering and Techniques - Volume 3 Issue 6, Nov - Dec 2017
- [26] Coulson & Richardson’s, “Chemical Engineering Design,” Elsevier Butterworth Heinemann, Vol. 6, No 4, (2005), pp. 634-724
- [27] Ramkrishna Gondane and Y. M. Jibhakate, Design and CFD Analysis of Shell and Tube Heat Exchanger Using Plain Tube and Corrugated Tube, *Vol-4 Issue-3 2018.IJARIIIE-ISSN(O)-2395-4396*
- [28] Roy Apu, Das D. H., (2011) “CFD analysis of a shell and finned tube heat exchanger for waste heat Recovery applications”, Mechanical & Industrial Engineering, Vol.1, 2431-1563.
- [29] VyasAlok, Sharma Prashant (2013) “An Experimental Analysis Study to Improve Performance of Tubular Heat Exchangers”, Engineering Research and Applications, Vol. 3, 2248-9622.
- [30] Ram Kishan, Devendra Singh and Ajay Kumar Sharma, CFD Analysis of Heat Exchanger Models Design Using Ansys Fluent. International Journal of Mechanical Engineering and Technology 11(2), 2020, pp. 1-9.
- [30] Azeb Tayework, 2018 Healthcare Waste Generation Rate, Composition, and Its Management System: At Selected Governmental Hospitals in Addis Ababa, Ethiopia.

[31] Yunus A. Çengel Heat And Mass Transfer: Fundamentals & Applications, Fifth Edition Published By McGraw-Hill Education, 2 Penn Plaza, New York, Ny 10121. Copyright © 2015 by McGraw-Hill Education.

[32] Saiful Bari, Shekh N Hossain, Waste Heat Recovery from a Diesel Engine Using Shell and Tube Heat Exchanger, Barbara Hardy Institute, School of Engineering, University of South Australia, Mawson Lakes Campus, SA 5095, Australia, 2013.

[33] V Jaya Prasad , “Thermal analysis of shell and tube type Heat exchanger to demonstrate the Heat transfer capabilities of various Thermal materials using ansys” vol 8,issue 2 (2017).

[34] J.P. Holman, Heat Transfer, Tata Mc Graw Hill international publishers 9th edition, 2002.

[35] Geological Survey of Ethiopia, Hydrocarbon laboratory Analysis Report, Addis Ababa, Ethiopia

[36]Guruprasath.K and Pushparaj.T, Shell Side Flow Behavior Analysis With Various Tube Bundle Alignment In Shell And Tube Heat Exchanger Using Cfd, International Research Journal of Engineering and Technology (IRJET) e-ISSN: 2395 -0056 p-ISSN: 2395-0072 Volume: 03 Issue: 04 | Apr-2016

[37] K Ashok Reddy, "A Review of Heat Transfer Studies for Shell & Tube Heat Exchangers", IJSDR, Volume 1, Issue 5, May 2016.

[38] Ankush S. Patil, H. S. Farkade, "Advances in Design and Development of Heat Exchangers: A Review", International Research Journal of Engineering and Technology (IRJET), Volume: 04, Issue: 05, May -2017.

[39] Prof. Naresh B. Dhamane et al, Heat Transfer Analysis of Helical Strip Insert with Regularly Spaced Cut Sections Placed inside a Circular Pipe. International Journal of Modern Engineering Research (IJMER) Vol. 2, Issue. 5, Sep.-Oct. 2012 pp-3711-3716.

[40] Muhammad Mahmoud Salam Butta, Nasir Hayat et.al,CFD Applications In Various Heat Exchangers Design: A Review, Department Of Mechanical Engineering, University Of Engineering & Technology, Applied Thermal Engineering, 2011

Appendixes

Appendix 1

Solid waste generation rate from Jimma University specialized hospital considering only ten beds as a reference in kg.

Table.1

No	Total Waste Per Bed in Kg
Day 1	0.82
Day 2	0.79
Day 3	0.77
Day 4	0.83
Day 5	0.765
Day 6	0.80
Day 7	0.78
Average	0.793

Energy Conversion of kWh to kJ

1kwh = 3600kj.....eqn.

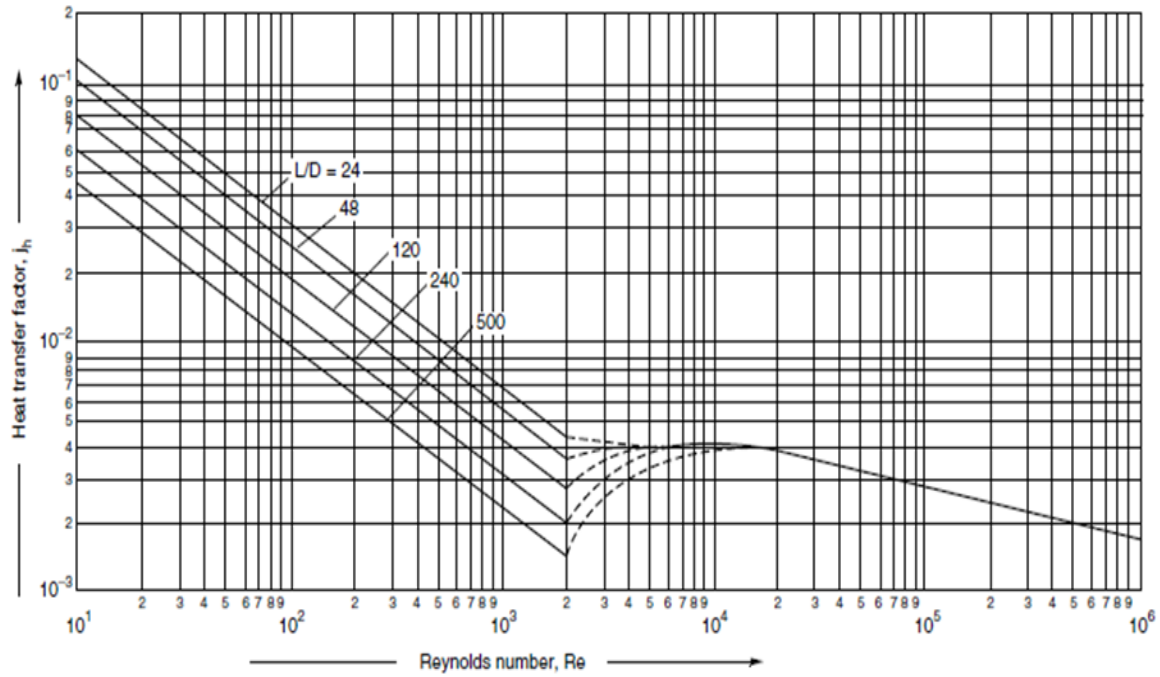

Figure 1. Tube-side heat-transfer factors

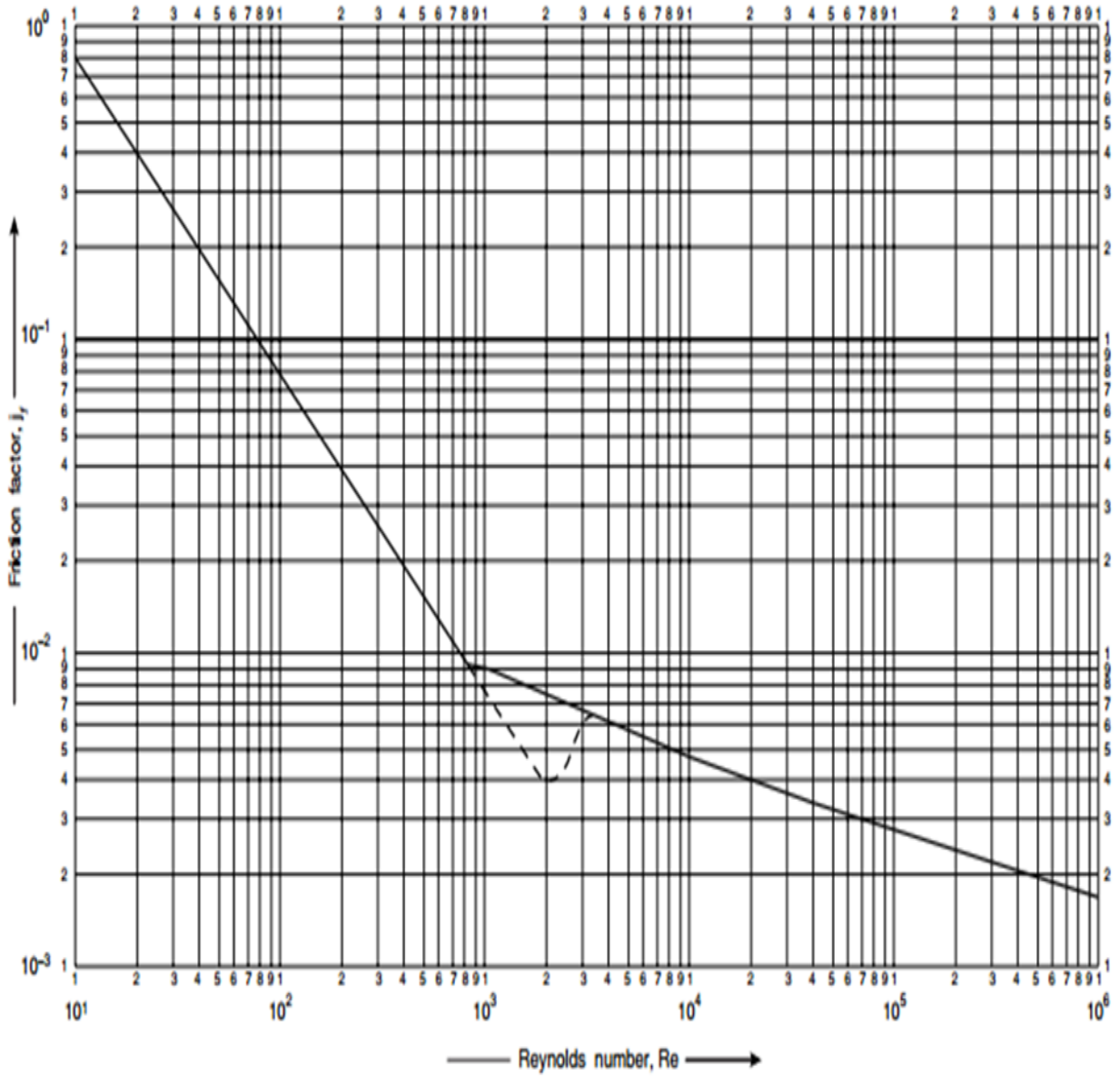

Figure2. Tube-side friction factors

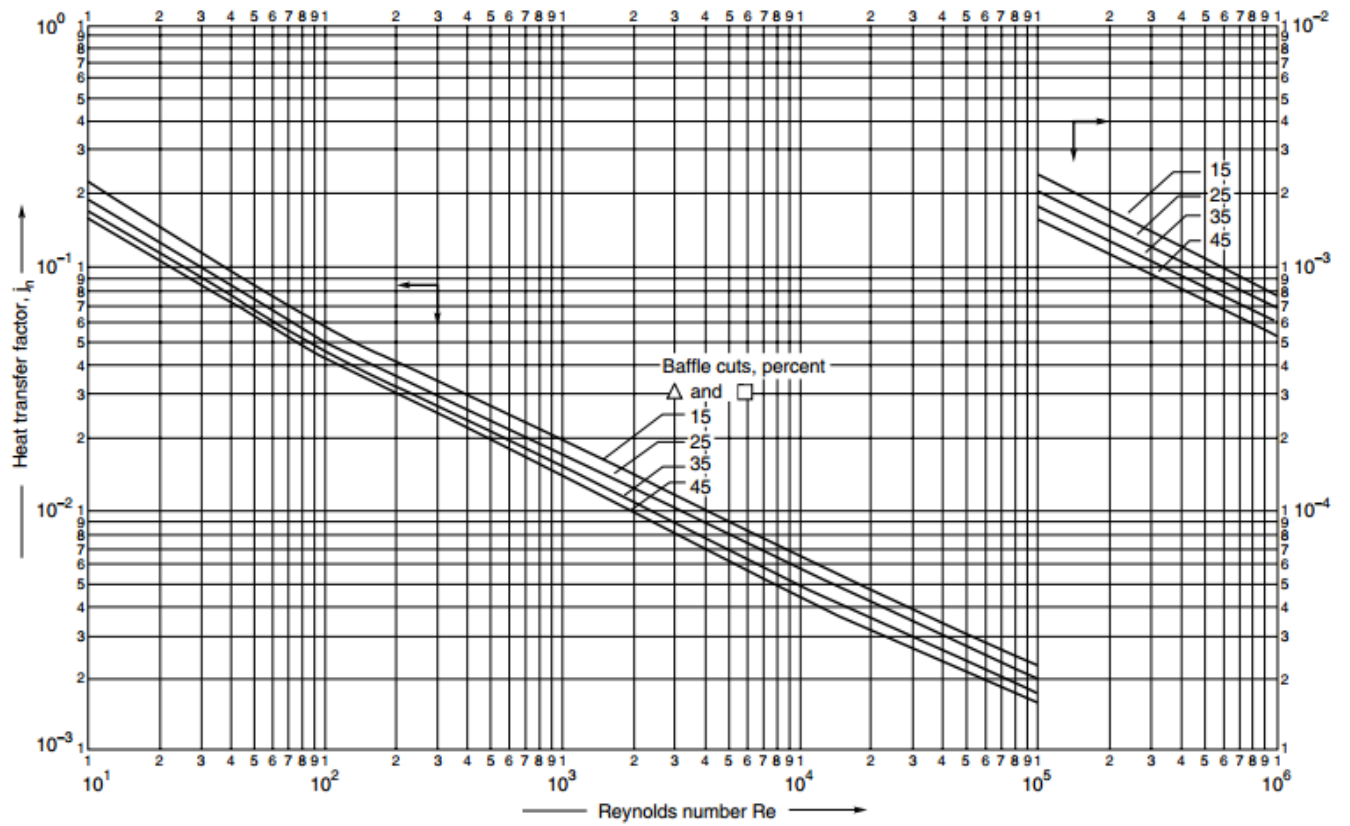

Figure3. Shell-side heat-transfer factors, segmental baffles

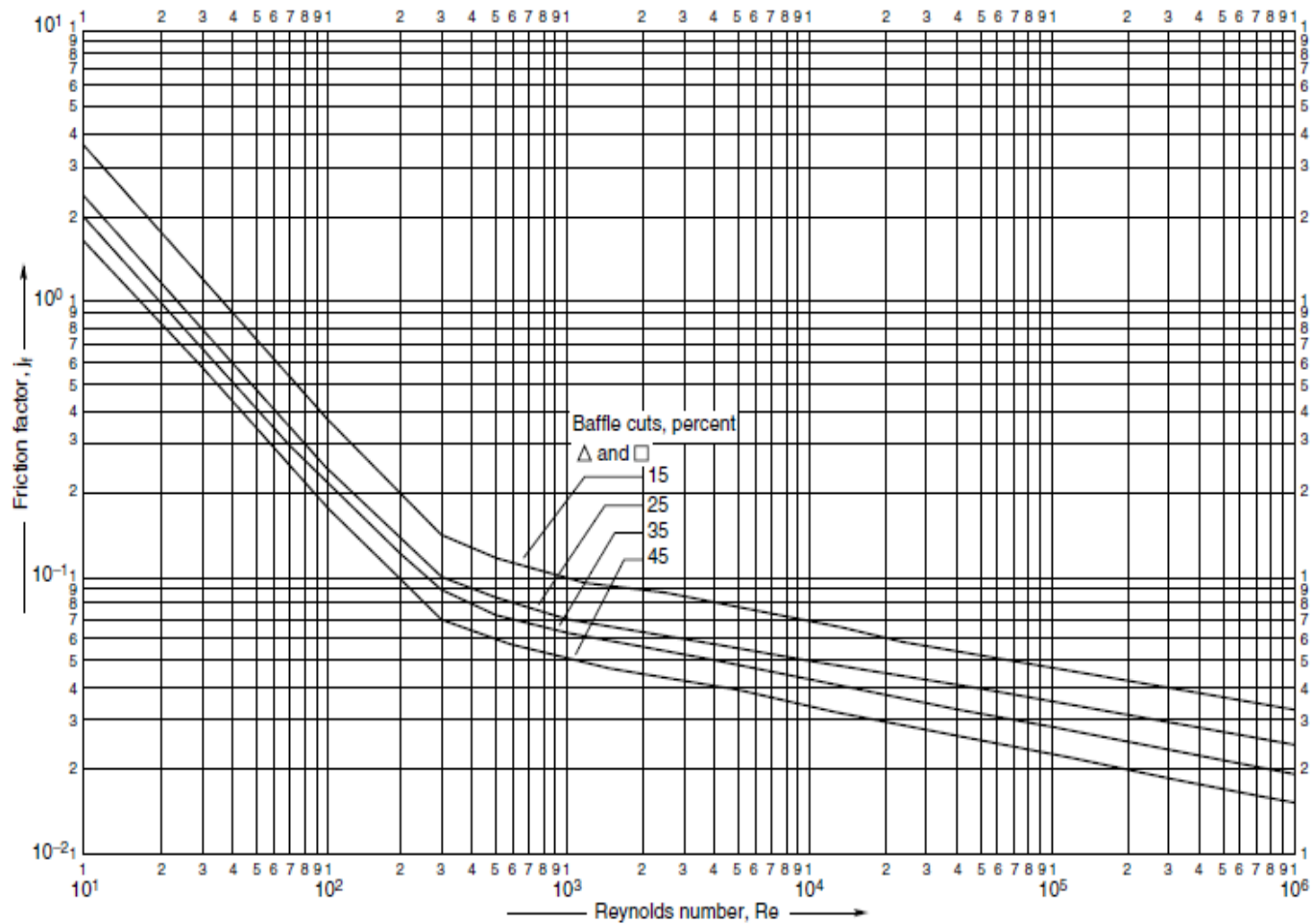

Figure4. Shell-side friction factors, segmental baffles.